



# 2019

## PRODUCT Solution Guide



BOARD AND MODULE  
SYSTEM AND PLATFORM  
TOUCH PANEL COMPUTER  
NETWORK APPLIANCE

[www.axiomtek.com](http://www.axiomtek.com)



# Table of Contents

## Overview

---

- 3 About Axiomtek
- 4 Product Design
- 5 Strength and Services
- 7 Product Lines
- 8 Global Website

## Product Highlights

---

- 9 New Product Highlights

## Solution Zone

---

- 22 Interactive Signage Solutions
- 23 Artificial Intelligence (AI) & Edge Computing Solutions
- 24 Automatic Vision Inspection Solution
- 25 DAQ and Predictive Maintenance
- 27 Smart Bus
- 29 Intelligent Warehouse Management
- 31 Intelligent Retail



## Boards and Modules

---

38	System on Modules
52	3.5" Embedded Boards
60	Pico-ITX SBCs
66	Mini-ITX Motherboards
74	ATX/Mirco ATX Motherboards
90	Slot CPU Cards
98	Smart Display Module
102	PCI Express Cards

## Systems and Platforms

---

111	Embedded Systems
138	Transportation Embedded Systems
153	DIN-rail Embedded Systems
188	Digital Signage Players
198	Embedded MicroBoxes
204	Industrial Systems
219	Intelligent Platform Solutions
226	Industrial Chassis

## Industrial Panel PCs

---

244	Fanless Touch Panel Computers
258	Heavy-duty Fanless Touch Panel Computers
273	Vehical Mount Terminal Computer
278	Stainless Touch Panel Computers
294	Transportation Touch Panel Computers and Displays
306	Industrial Touch Panel Computers
318	Industrial Touch Monitors
330	Medical Panel Computers
343	Open Frame Panel Computers

## Network Appliances

---

350	SOHO Network Appliances
356	SMB Network Appliances
366	Edge Server Platforms



# About **Axiomtek**

## Empowering IoT Innovation

For over 28 years, Axiomtek has been among the major design and manufacturing companies in the field of industrial computers and embedded systems. Since its establishment, Axiomtek has successfully gained worldwide recognition for our innovative designs and outstanding customer satisfaction. As a valuable & reliable industrial manufacturer, Axiomtek is devoted to producing state-of-the-art solutions that support users in achieving success. Axiomtek takes pride and ownership in what we do through our commitment to excellence.

**Vision** To be atop of the embedded computer industry, recognized by our partners as a trusted source of reliable products and dependable services

**Mission** To empower IoT innovation with reliable products and trusted services

**Value Systems**

- Passion:** We are passionate about our vision, our goals and our commitment to serve our employees and customers.
- Integrity:** We earn your trust through honest and ethical business practice.
- Innovation:** Our focus is on developing new products using the most advanced technologies and customer-based experiences.
- Partnership:** We commit to long-term mutual success with customers, employees and stakeholders.
- Leadership:** Our goal is always to be the leader in our targeted markets.
- Diversity:** We strive to diversify our products and services to serve specific industry needs.

# Product Design

## Boards and Modules

- Leading technology and comprehensive form factors
- Fast design-in services, time-to-market
- Custom BIOS services and flexible I/O modules supported
- Wide range temperature design capability for heavy-duty applications
- Quick turnaround time for ID/ME and working sample design

- EN 50155/EN 50121-4/EN 45545 certificate for rolling-stock and railway management
- E-Mark and ISO 7637 for in-vehicle applications
- IEC 60945/DNV 2.4 certificate for marine
- EtherCAT master controller for factory automation
- Intelligent remote management solution for IIoT (AXView)

## Systems and Platforms

- Heavy-duty design capabilities: extended temperature, fanless operation, anti-dust/water, anti-vibration, EMS and ESD
- Professional certified compliance and industrial standards
- Embedded OS and API capabilities to value-added custom systems
- IEC 61850/IEEE 1613 certificate for power grid and substations
- Intel® OPS and Intel OPS+ signage player for retail applications

## Industrial Panel PCs

- Design for human machine interface, medical, kiosk, etc.
- EN 50155/EN 50121-4 certificate for rolling-stock and railway management
- Value-added systems with remote and local diagnostic functions
- Peripherals integration for medical, kiosk, POS and security applications
- Specific environmental design capability with certification upon request

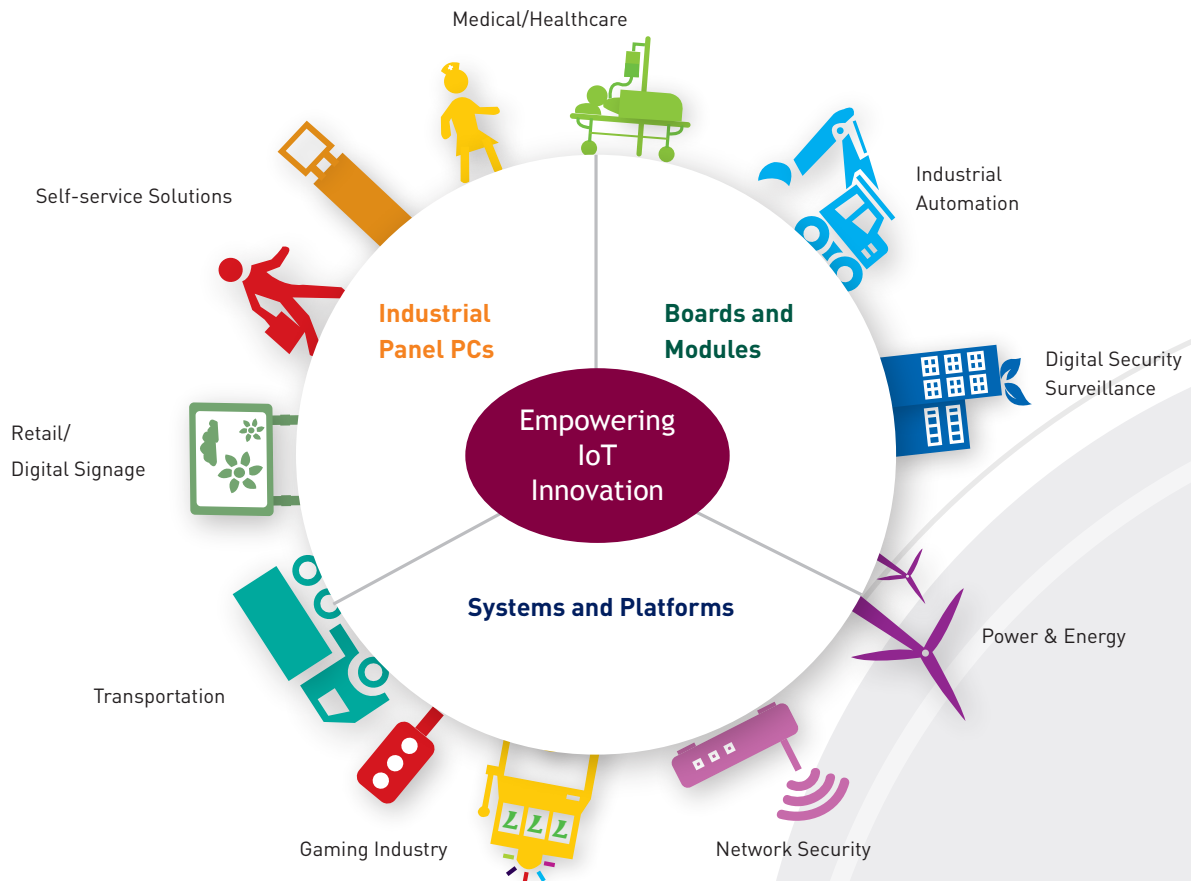



## Strength and Services

### Manufacturing Capacity

Over 8,000 square meters of factory space, along with the latest manufacturing equipment gives us the capacity to fully serve OEM/ODM businesses and while achieving high quality prompt deliveries at low cost. Our manufacturing site is equipped with the most advanced SMT assembly lines and optical inspection systems utilizing the lead-free technology. Being ISO 9001, ISO 14001, ISO 13485 and UL certified factory has also been engaged in manufacturing high density single-sided, doublesided, and multi-layer boards (up to 12 layers). With manufacturing facility and logistic centers in Taiwan, USA and China. Axiomtek is well positioned to meet the demanding business needs so as to ensure business success of Solution Integrators anywhere and anytime.



### Vertical Market Focus

Axiomtek's products are widely used in vertical markets such as gaming, automation, transportation, self-service, networking security, healthcare, digital video surveillance, power utility and digital signage applications. Axiomtek provides complete Embedded Board & SoMs, Industrial & Embedded Computers, Touch Panel Computers and all competitively priced solutions offered to system integrators, distributors, VAR's, and resellers. Axiomtek will also continue to emphasize the value of our selling partners and customers, and will maintain strong vertical market knowledge to develop and provide more efficient OEM/ODM programs.

### eRMA Service

Axiomtek's online eRMA service allows customers to access the most up-to-date information on repairs and also print test reports directly. All RMA tracking information is also conveniently available to view online.

### Software Service

To optimize system resources in demand, TCO (Total Cost of Ownership), system reliability and design of TTM (Time-to-Market), Axiomtek has established the embedded OS service force since 1999. Based on a platform concept, we combine two elements, a hardware SBC body and an embedded OS soul both constituting what we believe a perfect match for many application target applications.

### Quality Assurance

Axiomtek is an ISO 9001, ISO 14001, ISO 13485 (for medical panel computers/monitors only) and TÜV certified company. We maintain stringent quality standards in our manufacturing processes, ensuring products go through rigorous quality checks at every stage of its production cycle. As a global citizen, Axiomtek is committed to providing green products that are compliant with WEEE and RoHS regulations.







## Global Support

Axiomtek maintains a global network of international subsidiaries and distributors in more than 40 countries. To maximize service efficiency, Axiomtek employs an international service network. Our worldwide technical support and sales service among our 16 office locations located in Taiwan, North America, Europe, China, Malaysia, Thailand and Japan ensures we deliver dedicated and prompt services. Through our global network of international subsidiaries, customers obtain faster services and the most competitive pricing. Each project is fully supported by a group of experienced engineers, mechanical engineers, field application engineers, and sales coordinators from our worldwide offices. From concept to design, Axiomtek provides a comprehensive set of services to help you shorten your product development cycle and speed up your "Time to Market" gaining a competitive advantage. It has never been this easy to develop a project! With years of experience and knowledge, Axiomtek is your best partner for industry applications.

## Technical Support

Outstanding technical support is important to Axiomtek, therefore we have organized our customer service department into a team of technical support professionals from our headquarters as well as team members from global regions, providing real-time technical support and professional knowledge.

## Partnership

As an Intel®, Microsoft®, NXP and AMD partner, Axiomtek has ample awareness of market trends and can rapidly develop advanced applications that enhance the competitiveness of our customers.

**Microsoft Partner**  
Silver OEM





## Product Lines

Providing over 400 products through product lines of Industrial PCs (IPCs), Single Board Computers (SBCs), System on Modules (SoMs), Fanless and Rugged Embedded Systems (eBOX and rBOX), Intelligent Transportation Systems (tBOX and UST), Touch Panel Computers (TPCs), Medical Panel Computers (MPCs), Intelligent Retail Solutions, Industrial IoT Gateway, EtherCAT Master Controllers and Network Appliances (NAs), Axiomtek products are widely used in industrial automation, smart energy, transportation, kiosk, gaming, smart retail, healthcare, network infrastructure, and more.

## Embedded Boards & System on Modules

From System on Modules, embedded single board computers, industrial motherboards to slot CPU cards, Axiomtek provides a comprehensive range of board solutions with full computing architectures including x86 processors and ARM-based processors. Axiomtek can satisfy your various embedded application needs.

## Systems and Platforms

Axiomtek provides an extensive line of industrial & embedded computers, including embedded eBOX & tBOX systems, MicroBoxes, embedded field controllers, industrial barebone systems, industrial chassis, backplanes, among many other peripherals/accessories. The configured and fanless embedded eBOX series delivers high reliability, extended temperature and noiseless operation for harsh environments. The tBOX and UST series are especially designed for transportation applications such as vehicle, railway and marine markets. Their stability and reliability have earned an ISO 7637 and E-Mark certificates for vehicle applications, EN 50121 & EN 50155 certificates for railway applications and DNV 2.4, EN 45545-2 and IEC 60945 standards for marine market. The DIN-rail embedded systems constitute fanless embedded field controller solutions, specifically designed for intelligent computing and communication applications in smart energy and automation industries. Our digital signage platforms are compliant with various types of displays as well as suitable for different applications. To satisfy the demand for industrial applications, the industrial barebone system is designed for ATX industrial motherboard system markets, offering high level of reliability and performance. A wide range of PICMG 1.3/1.0 backplanes provide not only the highest compatibility with their power supply units unit but also the best extension slot selection. Our stable and reliable network appliance platforms boast of a lower total cost of ownership (TCO) and can be widely applied in VPN gateways, load balancing, network bandwidth management, SSL, firewalls, IDS/IPS, and many more.

## Industrial Panel PCs

Axiomtek has incorporated valuable features and latest technology into its touch panel computers to cater to today's competitive market. The GOT100/5000 series is equipped with an ultra slim ID, super light and fanless features for small-size infotainment applications. To resist severe conditions, the GOT800 adopts a sunlight readable LCD and IP66-rated water/dustproof design ideal for outdoor use in dusty or wet spaces. The GOT700 is an EN 50155 certified touch panel computer solution with alternative keypad and high brightness LCD for rolling stock. The GOT300, P1000 and P6000 series come with robust functions for industrial automation fields. Ideal for medical/healthcare applications, the MPC series is slim medical grade computers/monitors featuring low-noise operation, power saving, reliability and IPX1 water-proof design.

# Global Website

[www.axiomtek.com](http://www.axiomtek.com)

Axiomtek's multi-language website is designed using the latest Responsive Web Design technology (RWD) with rich, valuable, interactive information. Through our multi-language website you can access a wide variety of resources such as products, solutions, press releases, articles, eCatalogs, videos, downloads and more! Major sections of the Axiomtek multi-language website are as follow:

## Multi-languages

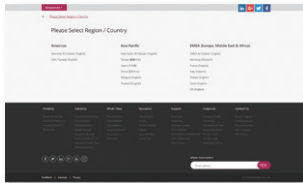

Visitors can select from a wide selection of languages including, English, German, French, Italian, Japanese, Traditional Chinese and Simplified Chinese.

## Various Products

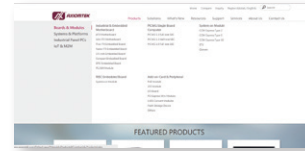

Axiomtek offers Embedded Boards & SoMs, Industrial & Embedded Computers, Network Appliances, signage and Touch Panel Computers. Customers can view product photos, features and ordering information and download complete product datasheets.

## Solutions

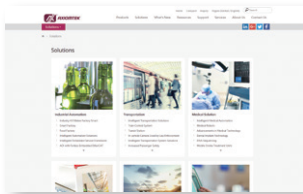

Here, you can refer to any vertical market in which your product offering is applicable. Configuration diagrams show how Axiomtek's products can be implemented into specific applications, and help customers build a successful solutions.

## eCatalogs & Videos



Here, you can find our environmentally-friendly paperless online catalogs and videos for additional product information.

## Supports

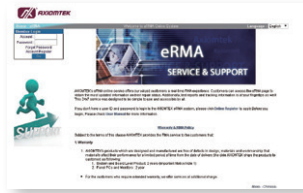

Axiomtek is devoted to providing the best customer services possible. Customers can obtain real-time update information such as manuals, drivers, VGA/LCD BIOS support lists and a FAQ database thru our eService. Axiomtek's creative eRMA online service offers a non-stop RMA service. Customers can access eRMA service, obtaining the most update information on repair and print test reports directly.

## Social Links

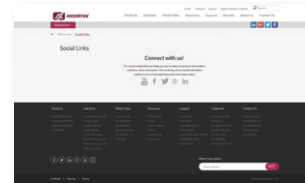

Axiomtek social media links can keep you up-to-date on product information, solutions, news and events. Axiomtek is devoted to providing various platforms to let people get information faster and easier. Search "Axiomtek" at any of social links to visit us and be sure to bookmark them and check back often!

## Partner Zone

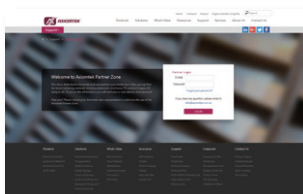

This page is exclusively provided for Axiomtek sales representatives, channel partners and distributors. Here you can find the latest marketing information and collateral such as datasheets, brochures, press releases, product images, as well as product and company presentations.

## eNewsletters



To provide customers with real time news from Axiomtek, customers can sign up our eNewsletters by visiting our eNews page directly for the latest product news, service updates, event invitations, and more!

## Mobile Website



Axiomtek mobile site is designed to provide a better reading experience, with a focus on simplicity. You will be presented with a clear view of products, news, and solutions with minimal distraction. You can access Axiomtek mobile site by entering [www.axiomtek.com](http://www.axiomtek.com) into your mobile device browser.

## Axiomtek APP



iOS



Android



# New Product Highlights

## System on Modules

---

### CEM700 >>Page 44



COM Express Type 7 Basic Module with Intel® Xeon® D-1500 & Pentium® Processor D1500

- Intel® Xeon® D-1500 and Pentium® Processor D1500 (Broadwell-DE)
- 2 DDR4-2400 S0-DIMM for up to 32GB of memory
- 1 PCIe x16 Gen3, 1 PCIe x8 Gen3, 8 PCIe x1 Gen2
- 2 SATA-600
- 4 USB 3.0 and 4 USB 2.0
- 2 10GBASE-KR
- TPM 2.0 supported

### CEB94017 >>Page 45

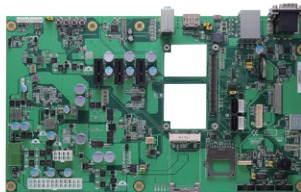

COM Express Type 10 Development Baseboard

- COM Express Type 10 baseboard
- 2 SATA-300 and SD card slot
- 1 PCI Express Mini Card slot
- 8 USB 2.0 and 2 USB 3.0
- Port 80 display for debugging

### CEB94701 >>Page 48

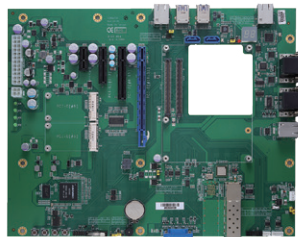

COM Express Type 7 Development Baseboard

- 2 10GBASE-KR SFP+ ports
- 2 SATA-600
- VGA
- 4 USB 3.0
- 2 PCI Express Mini Card slots
- 2 RS-232/422/485



## 3.5" Embedded Boards

---

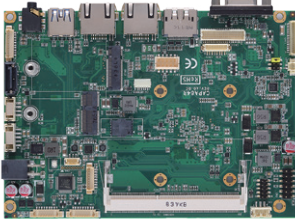

### **CAPA84R** >>Page 55

3.5" Embedded SBC with Intel® Celeron® Processor J1900/J1800, LVDS, VGA, DisplayPort, Three LANs and Audio

- Intel® Celeron® processor J1900/J1800
- 1 DDR3L SO-DIMM for up to 8GB of memory
- 2 USB 2.0 and 1 USB 3.0
- 3 GbE LANs
- M.2 Key E 2230
- M.2 Key B 2242

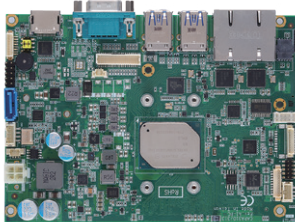

### **CAPA310** >>Page 57

3.5" Dual Embedded SBC with Intel® Atom® x5-E3940 Processor, LVDS, HDMI, Dual LANs and Audio

- Intel® Atom® x5-E3940 processor
- 1 DDR3L SO-DIMM for up to 8GB of memory
- 2 USB 2.0 and 4 USB 3.0
- 1 PCI Express Mini Card slot
- ZIO connector

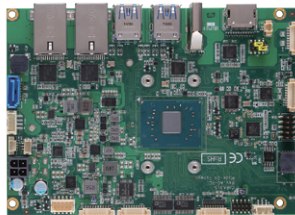

### **CAPA315** >>Page 59

3.5" Embedded SBC with Intel® Pentium® N4200 & Celeron® N3350 processor , eDP, Dual HDMI, Dual LANs and Audio

- Intel® Pentium® N4200/Celeron® N3350 processor
- 1 DDR3L SO-DIMM for up to 8GB of memory
- 2 USB 2.0 and 4 USB 3.0
- 2 HDMI and 1 eDP
- 1 PCI Express Mini Card slot

## Pico-ITX SBCs

---



### **PIC051R** >>Page 62

Pico-ITX SBC with 7th Generation Intel® Core™ i7/i5/i3 and Celeron® Processor, DisplayPort, LVDS and Dual LANs

- 7th generation Intel® Core™ i7/i5/i3 and Celeron® processor
- 1 DDR4 SO-DIMM for up to 16GB of memory
- 2 USB 2.0 and 2 USB 3.0
- M.2 Key E 22 x 30
- Intel® AMT 11 supported



### **PIC0319** >>Page 65

Pico-ITX SBC with Intel® Atom® x5-E3940 Processor, DisplayPort, LVDS, Dual LANs and Audio

- Intel® Atom® x5-E3940 processor
- 1 DDR3L SO-DIMM for up to 8GB of memory
- 2 USB 2.0 and 2 USB 3.0
- 1 PCI Express Mini card slot with mSATA supported
- 1 M.2 Key B 22 x 42

## Mini-ITX Motherboards

---

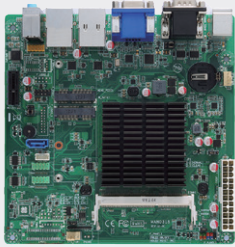

### MAN0315 >>Page 71

Mini-ITX SBC with Intel® Celeron® Processor J3355, VGA, HDMI, USB 3.0, PCI Express Mini Card Slot, mSATA and HD Audio

- Intel® Celeron® processor J3355 (Apollo Lake)
- DDR3L SO-DIMM for up to 8GB of memory
- 1 PCI Express Mini Card slot and PCIe x1
- 2 USB 3.0 and 4 USB 2.0
- 1 SATA-600 and 1 mSATA
- 4 COM supported
- STD ATX Power
- VGA and HDMI supported

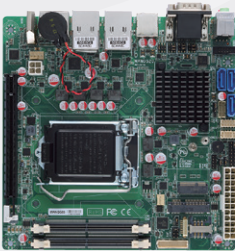

### MAN0520 >>Page 72

Mini-ITX SBC with LGA1151 8th Gen Intel® Core™ i7/i5/i3 Processor, Dual DisplayPort++, HDMI, LVDS, USB 3.0, mSATA, M.2 and HD Audio

- LGA1151 8th gen Intel® Core™ i7/i5/i3 processor
- Intel® H310 chipset (Q370 optional)
- 2 DDR4 SO-DIMM for up to 32GB of memory
- 4 USB 3.0 and 4 USB 2.0
- 4 COM ports
- 3 SATA-600 and 1 mSATA
- PCIe x16 and M.2 Key E
- 2 DisplayPort, 1 HDMI, 1 LVDS with triple-view supported



### MAN0521 >>Page 73

Thin Mini-ITX SBC with LGA1151 8th Gen Intel® Core™ i7/i5/i3 Processor, DisplayPort++, HDMI, LVDS, VGA, USB 3.0, M.2 and HD Audio

- LGA1151 8th gen Intel® Core™ i7/i5/i3 processor
- Intel® H310 chipset (Q370 optional)
- 2 DDR4 SO-DIMM for up to 32GB of memory
- 4 USB3.0 and 4 USB 2.0 ports
- 2 COM ports
- 2 SATA-600 and M.2 Key B
- PCIe x4, M.2 KEY E, PCI Express Mini Card slot

## ATX Motherboards

---



### IMB520 >>Page 81

ATX Motherboard with LGA1151 Socket 8th Gen Intel® Core™ Processor, Intel® Q370, USB 3.1 Gen2, SATA 3.0, Dual LANs, VGA, DP, DVI-D, and HDMI

- LGA1151 socket 8th gen Intel® Core™ i7/i5/i3, Pentium® & Celeron® processor (Coffee Lake)
- Four 288-pin DDR4-2666/2400 DIMM for up to 64GB of memory
- VGA, DisplayPort, DVI-D and HDMI with triple-view supported
- 4 SATA-600 with RAID 0/1/5/10
- Two USB 3.1 Gen2 and four USB 3.1 Gen1
- TPM 2.0 supported (optional)

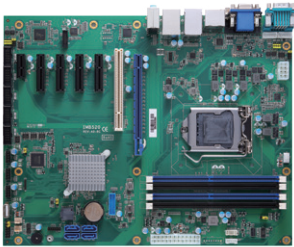

### IMB521 >>Page 82

ATX Motherboard with LGA1151 Socket 8th Gen Intel® Core™ Processor, Intel® C246, ECC DDR4, USB 3.0, SATA 3.0, Dual LANs, VGA, DP, DVI-D, and HDMI

- LGA1151 socket 8th gen Intel® Core™ i7/i5/i3, Pentium® & Celeron® processor (Coffee Lake)
- Four 288-pin DDR4-2133/2400 ECC DIMM for up to 64GB of memory
- DisplayPort, VGA, DVI-D and HDMI with triple-view supported
- 4 SATA-600 with RAID 0/1/5/10
- Two USB 3.1 Gen2 and four USB 3.1 Gen1
- TPM 2.0 supported (optional)

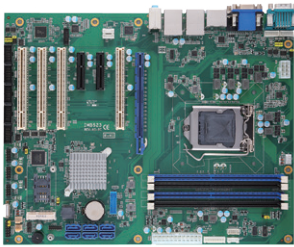

### IMB523 >>Page 83

ATX Motherboard with LGA1151 Socket 8th Gen Intel® Core™ Processor, Intel® Q370, USB 3.1 Gen2, SATA 3.0, Dual LANs, VGA, DP, DVI-D, and HDMI

- LGA1151 socket 8th gen Intel® Core™ i7/i5/i3, Pentium® & Celeron® processor (Coffee Lake)
- Four 288-pin DDR4-2666/2400 DIMM for up to 64GB of memory
- DisplayPort, DVI-D, HDMI and VGA with triple-view supported
- 6 SATA-600 with RAID 0/1/5/10
- Two USB 3.1 Gen2 and four USB 3.1 Gen1
- TPM 2.0 supported (optional)

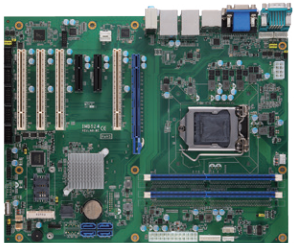

### IMB524 >>Page 84

ATX Motherboard with LGA1151 Socket 8th Gen Intel® Core™ Processor, Intel® H310, USB 3.1 Gen1, SATA 3.0, Dual LANs, VGA, DP, DVI-D, and HDMI

- LGA1151 socket 8th gen Intel® Core™ i7/i5/i3, Pentium® & Celeron® processor (Coffee Lake)
- Two 288-pin DDR4-2666/2400 DIMM for up to 32GB of memory
- DisplayPort, DVI-D, HDMI and VGA with dual-view supported
- 4 SATA-600
- 4 USB 3.1 Gen1 and 5 USB 2.0
- TPM 2.0 supported (optional)

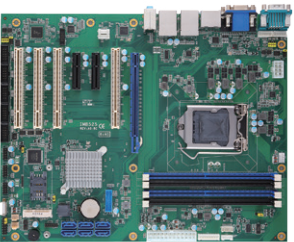

### IMB525 >>Page 85

ATX Motherboard with LGA1151 Socket 8th Gen Intel® Core™ Processor, Intel® C246, ECC DDR4, USB 3.1 Gen, SATA 3.0, Dual LANs, VGA, DP, DVI-D, and HDMI

- LGA1151 socket 8th gen Intel® Core™ i7/i5/i3, Pentium® & Celeron® processor (Coffee Lake)
- Four 288-pin DDR4-2666/2400 ECC DIMM for up to 64GB of memory
- DisplayPort DVI-D, HDMI and VGA with triple-view supported
- 6 SATA-600 with RAID 0/1/5/10
- Two USB 3.1 Gen2 and four USB 3.1 Gen1
- 1 PCI Express Mini Card slot
- TPM 2.0 supported (optional)

## PICMG 1.3 Full-size CPU Card

---



### SHB150 >>Page 96

PICMG 1.3 Full-size CPU Card with LGA1151 8th Gen Intel® Core™ Processor, Intel® C246/Q370/H310, SATA3, USB 3.1 Gen1/Gen2, Dual LANs and DVI-I

- LGA1151 8th gen Intel® Core™ processor (Coffee Lake)
- Intel® C246/Q370/H310 chipset
- 2 DDR4-2666/2400 Long-DIMM for up to 32GB of memory
- Supports Intel® AMT and vPro (C246/Q370)
- TPM 2.0 supported (optional)
- Supports M.2 Key M (C246/Q370)

## Smart Display Module

---

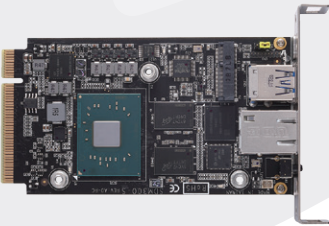

### SDM300S >>Page 100

Intel® Smart Display Module Small (SDM-S) with Intel® Pentium® Processor N4200 & Celeron® Processor N3350

- Intel® Smart Display Module (Intel® SDM) specification
- Intel® Pentium® processor N4200 & Celeron® processor N3350 (Apollo Lake)
- 4GB LPDDR4 memory onboard (8GB optional)
- 32/64GB eMMC onboard
- One M.2 Key E 2230 slot
- Two USB 3.0 and one GbE LAN
- Small design for easy integration into slim displays
- Optimized for digital signage, public kiosks, professional monitors, point-of-sale
- Projections for magic mirrors, beside terminals, hospitality, and more

## Data Acquisition Card

---

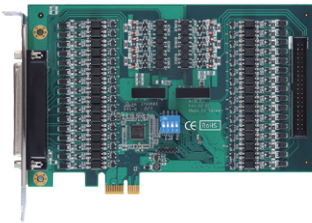

### AX92351 >>Page 105

32-CH Isolated Digital I/O PCI Express Card with Digital Filter

- 32-CH isolated digital input (compatibility: sink and source)
- 32-CH isolated digital output (with output status read back)
- Interrupt capability (smart interrupt)
- Digital filter function
- Supports board ID

## Frame Grabber & Vision I/O Card

---

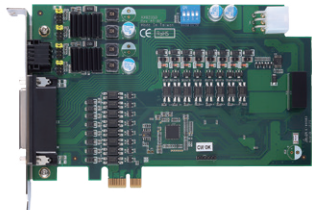

### AX92350 >>Page 104

Real-Time Vision I/O Card

- Integrated vision I/O
  - 4-CH trigger input
  - 4-CH or 8-CH trigger output
  - 4-CH LED lighting control (LED trigger output channels are defined by software settings)
  - 1-CH quadrature encoder input
  - 8-CH isolated DI, 8 CH isolated DO
  - 1-CH auto measurement function
- Programmable interrupt functions
- PCI Express x1 compliant
- Flexible design for vision inspection



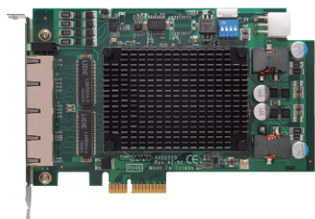

### AX92320 >>Page 103

#### 4-port PCI Express GigE Frame Grabber Card

- PCI Express x4 compliant
- 4 independent Gigabit PoE ports
- Supports 9.5KB Jumbo Frame and IEEE 1588
- Compliant with IEEE802.3at to deliver 30W at 54 VDC per port
- Up to 20/120W PoE power from PCIe 6-pin ATX power connector
- 0°C to +60°C operating temperature range
- PoE power management software
- Supports LAN port smart on/off

## Embedded Systems



### eBOX560-900-FL >>Page 122

#### Fanless Edge System with NVIDIA® Jetson™ TX2, 1 HDMI 2.0, 2 GbE LANs and 1 USB 2.0

- NVIDIA® Jetson™ TX2 with Pascal™, 256 CUDA cores GPU
- High AI computing performance for GPU-accelerated processing
- Ideal for intelligent edge applications
- Supports M2, NVMe SSD
- JetPack support
- Ultra-compact enclosure design



### eBOX625-312-FL >>Page 125

#### Fanless Embedded System with Intel® Celeron® N3350 2.4 GHz/ Pentium® N4200 2.5 GHz, 1 HDMI, 1 VGA, 2 GbE LANs, 6 USB and 3 COM

- Intel® Celeron® N3350/Pentium® N4200 onboard
- 204-pin DDR3L-1866 SO-DIMM for up to 8GB of memory
- Supports 2 GbE LANs, 3 COM and 6 USB 3.0
- One 2.5" SATA drive bay and mSATA supported
- Trusted Platform Module (TPM) 1.2
- 2 PCI Express Mini Card slots and 1 SIM slot
- -40°C to +70°C operating temperature range
- AXView 2.0 intelligent embedded monitoring software for IIoT



### eBOX627-312-FL >>Page 128

#### Fanless Embedded System with Intel® Celeron® N3350 2.4 GHz/Pentium® N4200 2.5 GHz, 1 HDMI, 2 GbE LANs, 6 USB, 4 COM and 9 to 36 VDC

- Intel® Celeron® N3350/Pentium® N4200 onboard
- 204-pin DDR3L-1866 SO-DIMM for up to 8GB of memory
- Support HDMI, 2 GbE LANs, 4 COM and 6 USB
- Flexible I/O Window supported
- Trusted Platform Module (TPM) 1.2
- -20°C to +70°C operating temperature range
- 9 to 36 VDC wide range DC input
- AXView 2.0 intelligent embedded monitoring software for IIoT



### eBOX638-842-FL >>Page 129

Fanless Embedded System with Intel® Celeron® Processor J1900, 1 VGA, 1 HDMI, 4 COM, 6 USB, Dual Expansion Slots and 9 to 36 VDC Input

- Intel® Celeron® Processor J1900 2.0 GHz
- Fanless operation design with full feature I/O
- HDMI and VGA with dual-view supported
- 6 USB, 2 LANs and 4 COM
- 1 PCI Express Mini Card slot
- Flexible I/O window design
- Dual PCI or PCIe x1 expansion slots
- 9 to 36 VDC wide range power input

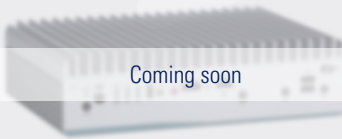

### eBOX671-517-FL >>Page 132

Fanless Embedded System with LGA1151 Socket 7th/6th Gen Intel® Core™ i7/i5/i3 & Celeron® Processor, Intel® Q170, 1 HDMI, 1 DVI-D, 1 VGA, 8-CH PoE, 6 USB and 9 to 36 VDC

- -40°C to +70°C extended operating temperature
- 7th/6th gen Intel® Core™ i7/i5/i3 & Celeron® processor (35W/65W)
- 8-CH PoE/GbE onboard
- Supports 6 USB ports and 4 GbE LANs
- 2.5" SATA HDD drive bay and mSATA slot
- Intelligent solution for factory automation



### eBOX671-521-FL >>Page 133

Fanless Embedded System with LGA1151 8th Gen Intel® Core™ i7/i5/i3 & Celeron® Processors, 4-CH PoE and MXM Graphics Module

- 8th gen Intel® Core™ i7/i5/i3 & Celeron® with Intel® Q370 chipset (Coffee Lake-S)
- 4-CH GbE PoE (IEEE802.3at)
- Dual swappable 2.5" SATA HDD drive bay
- ECC memory supported by optional Intel® C246 PCH
- Supports MXM graphics module (optional)
- DVI-I, HDMI, and DisplayPort with triple-view supported
- AXView 2.0 intelligent embedded monitoring software for IIoT



### eBOX800-511-FL >>Page 136

Rugged IP67-rated Fanless Embedded System with Intel® Core™ i5-7300U & Celeron® 3965U, 1 VGA, 1 GbE LAN, 2 USB, 2 COM and 9 to 36 VDC

- IP67-rating for outdoor use
- Intel® Core™ i5-7300U & Celeron® 3965U onboard
- 4 N-jack antenna openings with water proof design
- 9 to 36 VDC wide range power input
- -30°C to +60°C operating temperature range
- Features M12 lockable I/Os
- Rich I/O options for customized designs and mission-critical projects
- Trusted Platform Module 1.2 (TPM) 1.2



### eBOX800-900-FL >>Page 137

Rugged IP67-rated Fanless Edge System with NVIDIA® Jetson™ TX2, 1 HDMI, 1 GbE LAN, 1-CH PoE, 1 USB 2.0 and 100 to 240 VAC Power Input

- IP67-rating for outdoor use
- NVIDIA® Jetson™ TX2 with Pascal™, 256 CUDA cores GPU
- High AI computing performance for GPU-accelerated processing
- -30°C to +60°C operating temperature range
- 100 to 240 VAC wide range power input with 10kV surge protection
- 4 N-jack antenna openings with water proof design
- Features M12 lockable I/Os
- 1 IEEE 802.3at GbE LAN port (30W)
- Rich I/O options for customized designs and mission-critical projects

## DIN-rail Embedded System

---



### IC0500-518 >>Page 171

Fanless Embedded System with 7th Gen Intel® Core™ i7/i5/i3 & Celeron® Processors  
Dual Modular I/O Expansion Design

- 7th gen Intel® Core™ i7/i5/i3 & Celeron® processors (Kaby Lake-U)
- 2 PIM (Plug-in IO Module) slots, wide selections
- Fanless and compact design
- Wide operating temperatures from -20°C to +70°C [-40°C to +70°C optional]
- 12 to 48 VDC wide range power input
- OVP, UVP, OCP, RPP power protection design
- 1 swappable 2.5" SATA drive tray

## Open Pluggable Specification Signage Players

---



### OPS700-520 >>Page 191

Open Pluggable Specification-Plus (OPS+) Digital Signage Player with LGA1151 Socket  
8th Gen Intel® Core™ i7/i5/i3 & Celeron® Processor, Intel® Q370 and TPM 2.0

- Intel® Open Pluggable Specification-Plus (OPS+ compliance)
- 8th gen Intel® Core™ i7/i5/i3 & Celeron® processors (Coffee Lake-S)
- 2 DDR4-2400 SO-DIMM for up to 32GB of memory
- 1 M.2 KEY M for storage
- 1 M.2 KEY E for Wi-Fi solution
- Supports additional DisplayPort and PCIe x4 through HRS-FX18 connector
- Supports Intel® AMT11.0 and Intel® Unite
- Supports Trusted Platform Module (TPM) 2.0
- Easy installation and maintenance



### OPS500-520-H >>Page 192

Open Pluggable Specification (OPS) Digital Signage Player with LGA1151 Socket  
8th Gen Intel® Core™ i7/i5/i3 & Celeron® Processor, Intel® H310 and TPM 2.0

- Intel® Open Pluggable Specification (OPS compliance)
- 8th gen Intel® Core™ i7/i5/i3 & Celeron® processors (Coffee Lake-S)
- 2 DDR4-2400 SO-DIMM for up to 32GB of memory
- 1 M.2 KEY M for storage
- 1 M.2 KEY E for Wi-Fi solution
- USB 3.1 Gen1 supported
- Trusted Platform Module (TPM) 2.0
- Easy installation and maintenance

## Digital Signage Player

---



### DSP300-318 >>Page 196

Digital Signage Player with Intel® Pentium® Processor N4200 & Celeron®  
Processor N3350, DisplayPort+/HDMI, 2 GbE LANs and 4 USB

- Fanless operation with low power consumption
- 2 DDR3L-1600 SO-DIMM for up to 8GB of memory
- 1 HDMI 1.4 and 1 DisplayPort 1.2
- 4 USB, 2 GbE LAN
- 1 M.2 Key E 2230 for WiFi/BT
- 1 M.2 Key B 3042 for 4G LTE
- 1 M.2 Key M 2280 for storage

## Industrial Systems

---



### IPC962-512-fl >>Page 207

2-slot Fanless Industrial System with LGA1151 Socket 7th/6th Gen Intel® Core™ i7/i5/i3 & Celeron® Processor, Intel® Q170 Chipset, and Front-access I/O, PCIe and PCI Slots

- LGA1151 Socket 7th/6th gen Intel® Core™ i7/i5/i3 & Celeron® processor, up to 35W
- Intel® Q170 chipset
- Supports 2 expansion slots
- Power input: 24 VDC (uMin=19V/uMax=30V)
- Compact & front I/O design
- -10°C to +60°C operating temperature range
- Supports 2 swappable 2.5" HDD & RAID 0,1
- Supports optional WLAN module & antenna
- Supports TPM 2.0 optional



### IPC310-501 >>Page 217

Wall Mount Industrial System with LGA1151 Socket 7th/6th Gen Intel® Core™ Processor, Intel® H110, USB 3.0, SATA 3.0, Dual LANs, VGA, DisplayPort, HDMI and mSATA

- Wall mount industrial computer chassis
- LGA1151 socket 7th/6th gen Intel® Core™ i7/i5/i3, Pentium® & Celeron® processor (Kaby Lake/Skylake)
- 2 288-pin DDR4-2133/1866 DIMM, up to 32GB
- DisplayPort, HDMI and VGA with dual-view supported
- 3 SATA-600
- 4 USB 3.0 and 4 USB 2.0
- Supports mSATA and PCI Express Mini Card slot

## Vision Systems

---



### IPS960-511-PoE >>Page 221

Vision System with LGA1151 Socket 7th/6th Gen Intel® Core™ i7/i5/i3 & Celeron®, Intel® H110 Chipset, 4 PoE, 4 USB 3.0, and Real-time Vision I/O

- Integrated real-time vision I/O
  - 4 CH trigger input
  - 4 or 8 CH trigger output
  - 4 CH LED lighting control
  - 1 CH quadrature encoder input
  - 16 CH isolated DIO
  - 1 CH auto measurement function
- Supports camera interfaces
  - 4 IEEE802.3at GbE LAN ports (PoE)
  - 4 USB 3.0 ports
- Power input: 24 VDC (uMin=19V/uMax=30V)
- -10°C to +55°C operating temperature range
- Supports 2 swappable 2.5" HDD
- Supports optional WLAN module & antenna
- Supports TPM 2.0 function
- Compact & front I/O design





### IPS962-512-PoE >>Page 223

Vision System with LGA1151 Socket 7th/6th Gen Intel® Core™ i7/i5/i3 & Celeron®, Intel® Q170 Chipset, 4 PoE, 4 USB 3.0, and Real-time Vision I/O

- Integrated real-time vision I/O
  - 4 CH trigger input
  - 4 or 8 CH trigger output
  - 4 CH LED lighting control
  - 1 CH quadrature encoder input
  - 16 CH isolated DIO
  - 1 CH auto measurement function
- Supports camera interfaces
  - 4 IEEE802.3at GbE LAN ports (PoE)
  - 4 USB 3.0 ports
- Power input: 24 VDC (uMin=19V/uMax=30V)
- -10°C to +55°C operating temperature range with W.T. SSD
- Supports 2 swappable 2.5" HDD
- Supports optional WLAN module & antenna
- Supports TPM 2.0 function
- Compact & front I/O design

## Industrial Chassis



### AX60810 >>Page 229

Wall mount Chassis

- Support ATX/micro-ATX motherboard
- Front-accessible one 5.25" HDD and two 3.5" HDD drive bays
- Equipped with a PS/2 type power supply
- One 12cm ball-bearing fan
- Bidirectional mounting chassis
- Easy removable filter
- Flexible I/O opening on rear

## Fanless Touch Panel Computers



### GOT107W-319 >>Page 247

7" WSVGA TFT Fanless Touch Panel Computer with Intel® Celeron® Processor N3350

- 7" WSVGA TFT LCD display with LED backlight
- Fanless design with Intel® Celeron® processor N3350
- 2 GbE LANs, 2 USB and 2 COM
- Plastic and IP65-rated front bezel
- Supports RFID (optional)
- External AT/ATX mode selection switch
- Easy access storage design
- Supports optional panel mount/wall mount/VESA mount /desktop stand

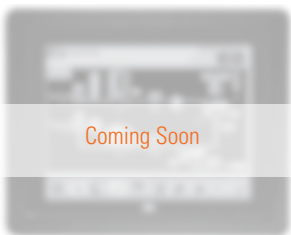

### GOT115-319 >>Page 251

15" XGA TFT Fanless Touch Panel Computer with Intel® Celeron® Processor N3350

- 15" XGA TFT LCD display with LED backlight
- Fanless design with Intel® Celeron® processor N3350
- 2 GbE LAN, 4 USB and 2 COM
- Plastic and IP65-rated front bezel
- Supports RFID (optional)
- External AT/ATX mode selection switch
- Easy access storage design
- Supports optional panel mount/wall mount/VESA mount/desktop stand
- Adjust RS-232/422/485 setting and 5V/12V powered COM via BIOS
- Supports PoE card (optional)

## Heavy-duty Fanless Touch Panel Computers

---



### GOT315WL-845-PCT >>Page 263

15.6" WXGA TFT Multi-touch Panel Computer with Intel® Pentium® Processor N3710 (0°C to +50°C)

- 15.6" WXGA projected capacitive multi-touch wide screen
- Fanless design with Intel® Pentium® processor N3710
- 2.5" SATA HDD & mSATA
- 3G, WLAN module & antennas (optional)
- 2 GbE LANs, 2 USB 3.0, 2 USB 2.0 and 2 COM
- IP65 aluminum front bezel
- Supports panel mount and optional VESA arm/desktop stand/wall mount
- Adjust RS-232/422/485 setting via BIOS



### GOT318WL-845-PCT >>Page 265

18.5" WXGA TFT Multi-touch Panel Computer with Intel® Pentium® Processor N3710 (0°C to +50°C)

- 18.5" WXGA projected capacitive multi-touch wide screen/Flat resistive touch (optional)
- Fanless design with Intel® Pentium® processor N3710
- 2.5" SATA HDD & mSATA
- 3G, WLAN module & antennas (optional)
- 2 GbE LANs, 2 USB 3.0, 2 USB 2.0 and 2 COM
- IP65 aluminum front bezel
- Supports panel mount and optional VESA arm/desktop stand/wall mount
- Adjust RS-232/422/485 setting via BIOS

## Transportation Touch Panel Display

---



### P6125 >>Page 303

12.1" XGA TFT EN 50155 Railway Touch Display (-25°C to +55°C)

- EN 50155 compliant monitor for railway application
- 12.1" high brightness XGA TFT touchscreen LCD
- Wide viewing angle and high brightness 800 nits
- VGA, DVI-D and HDMI with multiple video inputs
- Light sensor for auto-dimming (optional)
- 24 VDC to 110 VDC power input
- -25°C to +55°C wide temperature range
- Supports 5 keys OSD

## SMB Network Appliances

---



### NA861 >>Page 361

1U Rackmount Network Appliance Platform with LGA3647 Socket Intel® Skylake Server Processor, Intel® C621 (Purley) and up to 34 LANs

- LGA3647 socket Intel® Skylake server processor
- 6 DDR4-2400 R-DIMM for up to 384GB of memory
- Max. up to thirty-four 10/100/1000 Mbps Ethernet ports
- 4 expandable LAN modules supporting 1GbE/10GbE/25GbE/40GbE/Fiber/Copper/Bypass
- Supports 1U redundant power supply
- Supports IPMI/TPM (onboard) for optional
- High computing power for SDN, NGFW, IDS, IPS and UTM applications



### NA590 >>Page 362

1U Rackmount Network Appliance Platform with LGA1151 Socket Intel® Xeon® E/Core™ Processor, Intel® C246/H310 and up to 26 LANs

- LGA1151 socket 8th Intel® Core™/Xeon® E-21XX processor (Coffee Lake)
- 4 DDR4-2666 U-DIMM for up to 64GB of memory
- Max. up to twenty-six 10/100/1000 Mbps Ethernet ports
- 2 expandable LAN modules supporting 1GbE/10GbE/25GbE/40GbE/Fiber/Copper/Bypass
- Supports 1U redundant power supply for optional
- Supports IPMI/TPM for optional
- Suitable for network security, cloud computing and data centers applications

## Edge Server Platforms

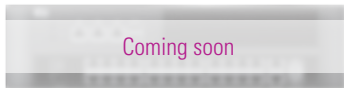

### iSvr560 >>Page 368

2U Compact Edge Server Platform with Intel® Coffee Lake Xeon® Processor and 24-port GbE Managed Switch

- Intel® Coffee Lake Xeon® processor
- Four 288-pin DDR4 R-DIMM for up to 64GB of memory
- 24-port GbE managed switch
- Supports L3 switch function
- Supports GPU card
- Supports IPMI 2.0 remote management

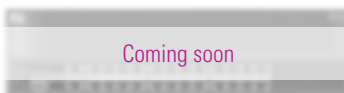

### iSvr660 >>Page 369

2U Slim Edge Server Platform with Intel® Dual Purley Scalable Processor and 24-port GbE Managed Switch

- Intel® Purley scalable dual processor
- Twelve 288-pin DDR4 R-DIMM for up to 384GB of memory
- 24-port GbE managed switch
- Supports L3 switch function
- Supports two GPU card
- Supports IPMI 2.0 remote management



# Solution Zone

Axiomtek offers solutions of highly competitive prices to system integrators, distributors, value-added resellers (VARs), and resellers. Axiomtek products are widely used in industrial automation, data acquisition, DVR, healthcare, banking, entertainment, transportation, POS/POI, kiosk, HMI, gaming machine, digital signage, digital surveillance, security, network communication, telecom, and more.

## Market Coverage

### AUTOMATION

Factory Automation, Process Automation, Robot Industry, Facility Monitoring System, Machine Automation, Building Automation, and Automatic Optical Inspection

### TRANSPORTATION

Traffic Control System, Rail Rapid Transit, In-vehicle Infotainment, Surveillance, Car PC, Fleet Management, Electric Vehicle, and Marine Application

### POWER UTILITY

Green Energy, Efficient Energy, Power Generation & Distribution, and Power Plant Automation

### INDUSTRIAL IoT

Smart Home, Smart Grid, Intelligent Transportation, Automotive Manufacturing & Smart Factory, Healthcare, Digital Signage and Retail

### GAMING

Casino Slot Machines, Gaming Management Systems, and Amusement Gaming Machines

### MEDICAL

eHealthcare, Medical Imaging, Point of Care, Nursing Car, and Telemedicine

### SELF-SERVICE

Point of Sales (POS), Kiosk, and Information Terminals

### NETWORK

Firewall, VPN, UTM, Anti-spam, Anti-virus, and Load Balancing

### DIGITAL SIGNAGE

Public Information Display, Storefront Digital Media Campaigns, and Interactive Whiteboard

# Interactive Signage Solutions

As advanced computer technology brings innovative ways to improve communication and interaction, the market for interactive signage continues to grow every year in size and scope. Axiomtek's OPS product series is designed to deliver true customer value by providing high performance computing, exceptional graphics performance, streamlined installations and low-cost maintenance.



e-Board for Conference Room  
**OPS300-310**

The OPS300-310 supports the Intel® Celeron® processor N3350 with turbo boost up to 2.4 GHz. Featuring fanless design which ensures completely noiseless operation, 4K ultra HD resolution and TPM 2.0, the OPS300-310 is suitable for various multiple display solutions such as e-board in the meeting room, as well as digital signage in the shopping mall, retail store, hospital, bank, restaurant, etc. It also comes with one PCI Express Mini Card, one M.2 Key E card, and one SIM slot for maximum expandability. To meet diverse display needs, the OPS300-310 offers a variety of display options through DisplayPort, HDMI 2.0, and VGA ports.



Interactive Whiteboard Solution  
for Education **OPS500-520-H**

The OPS500-520-H is a 4K resolution OPS compliant digital signage player powered by the 8th generation Intel® Core™ processor with Intel® H310 chipset and TPM2.0 embedded. It has two 260-pin DDR4-2400 SO-DIMM sockets with up to 32GB memory capacity and delivers high performance computing and exceptional graphics quality, making it an ideal Interactive Whiteboard solution for educational applications. Compliant with the Intel® OPS architecture, the 4K-ready signage player provides a high level of compatibility to simplify installation, maintenance and deployment for a lower total cost of ownership. Also, this OPS signage player has one M.2 Key E 2230 for WLAN connectivity and features one M.2 Key M 2230, which supports high performance NVM Express interface for extensive storage needs.



Video Wall  
**OPS700-520**

The OPS700-520 is a 4K resolution OPS+ compliant digital signage player powered by the 8th generation Intel® Core™ processor with Intel® Q370 chipset and TPM2.0 embedded. It has two 260-pin DDR4-2400 SO-DIMM sockets with up to 32GB memory capacity. The OPS700-520 is capable of supporting triple independent displays with 4K resolution through 2 DisplayPort and one HDMI 2.0 port, which is ideal for video wall applications. Compliant with the Intel® OPS+/OPS architecture, the space-saving signage player provides a high level of compatibility to simplify installation, maintenance and deployment for a lower total cost of ownership. Also, the 4K-ready OPS+ signage player supports Intel® AMT11.0 for better remote and control management, featuring one M.2 Key E 2230 for WLAN connectivity and one M.2 Key M 2230, which supports high performance NVM Express interface for extensive storage needs.





## Artificial Intelligence (AI) & Edge Computing Solutions

Axiomtek's eBOX560-900-FL and eBOX800-900-FL are powered by NVIDIA® Jetson™ TX2 Supercomputer-on-Module, it brings powerful AI capabilities at the edge. They feature an integrated 256-core NVIDIA® Pascal GPU, a hex-core ARMv8 64-bit CPU complex, and 8GB of LPDDR4 memory, which is ideal for AI edge computing applications, such as AI smart city, smart manufacturing, machine vision, deep learning, edge computing, and much more.

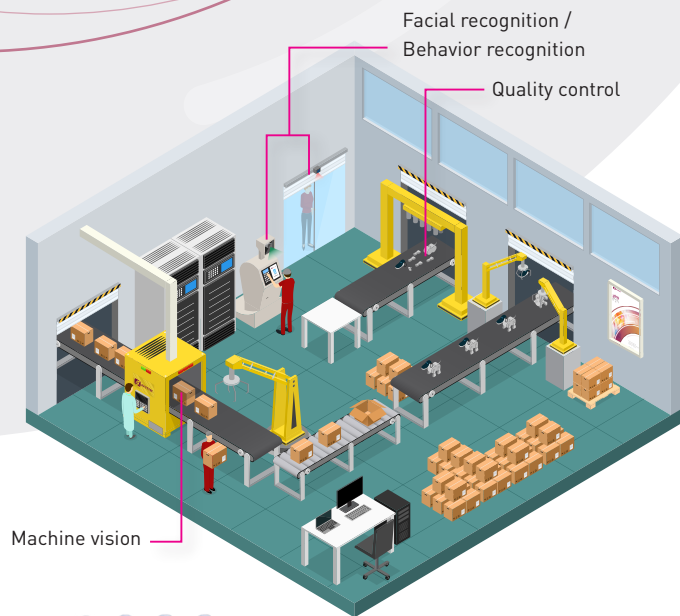

Machine vision

Facial recognition /  
Behavior recognition

Quality control



**eBOX560-900-FL**  
Factory Automation

Axiomtek's eBOX560-900-FL offers rich features in a compact, palm-sized box. This AI-ready system comes equipped with two-Gigabit Ethernet ports, one HDMI 2.0 port and one onboard 32GB eMMC. It is also equipped with one M.2 SSD PCIe 2.0 x4 socket which supports a high performance NVM Express interface for maximum storage needs. The eBOX560-900-FL also features a PCI Express Mini Card slot for 3G/4G/LTE connections.



**eBOX800-900-FL**  
Smart Traffic

Axiomtek's eBOX800-900-FL is an ideal embedded system for edge computing and intelligent traffic applications, especially in harsh outdoor environments. This embedded system is IP67-rated for protection against dust and water damage and comes with 10 kV surge protection. It also features one M.2 SSD PCIe 2.0 x4 socket which supports a high performance NVM Express interface for additional storage needs. The eBOX800-900-FL is equipped with one PoE for connection with an IP camera.

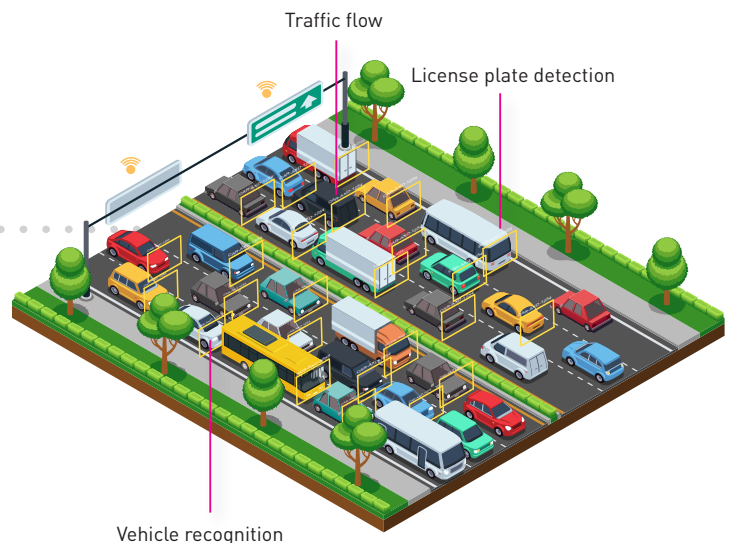

Traffic flow

License plate detection

Vehicle recognition

# Automatic Vision Inspection Solution

The arrival of the industrial 4.0 era has improved the efficiency of production lines and increased productivity of all levels through the use of computer automation technology. Consistent product quality can be achieved with much less waste. Automated Optical Inspection (AOI) systems, for instance, have replaced the manual quality control method used in the past. It enables fast and accurate inspections of the products being assembled to ensure that the desired quality is achieved with no manufacturing defects. Coupled with the new generation of wireless technology, AOI has allowed the inspection platform to capture larger amounts of data for analysis and convert them into valuable information and actionable plans for operational improvements.



## IPS960-511-PoE

Axiomtek's IPS960-511-PoE has flexible design for intelligent platform and is powered by the LGA1151 Socket 7th/6th generation Intel® Core™ i7/i5/i3 or Celeron® Processor, supporting two swappable 2.5-inch HDD to meet different requirements. The design for wide temperature range from -10°C to +55°C ensures reliable and stable performance even when the system is operating in harsh environments. The front I/O design of the system supports multiple camera interfaces. Users can also integrate Axiomtek's GigE Frame Grabber Card and Real-Time Vision I/O Card into the system to develop applications for specific production facilities, such as food factories.

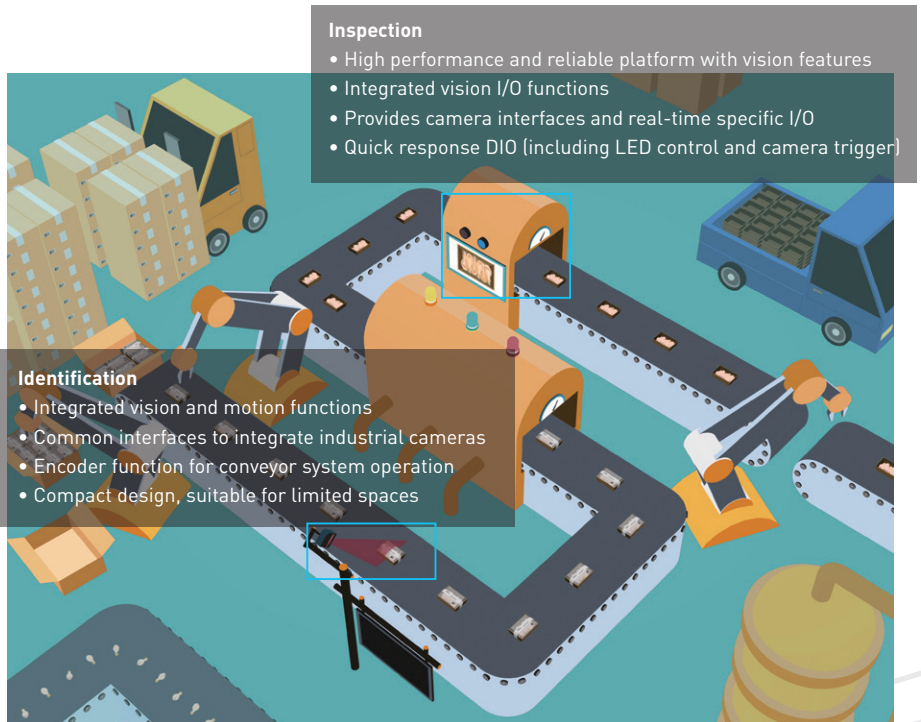

## AX92320

Axiomtek's AX92320 supports PCI Express x4 lane, four independent Gigabit 802.3at (PoE, Power-over-Ethernet) compliant Ethernet ports and GigE Vision camera compliance. The 4-port PCI Express x4 frame grabber can provide up to 30 watts at 54 VDC power per port, which allows power to be supplied to connected PoE-based devices, such as GigE Vision cameras in machine vision systems. The intelligent GigE Vision card also supports IEEE 1588 (precise time protocol), enabling synchronization with multi-camera acquisition. Combining IEEE 1588 and PoE function, the card utilizes a single Ethernet cable for power, data, and synchronization.



## AX92350

The Axiomtek's AX92350 is a PCI Express x1 vision card with vision-specific I/Os and real-time controls. A machine vision system requires accurate interaction between lighting, cameras, actuators and sensor devices. The AX92350 vision I/O card integrates LED lighting controller, camera trigger, encoder input, and digital I/O to connect and control all the vision devices. The encoder input function is particularly suited for conveyor applications. The vision I/O card supports 4-CH trigger input, 4-CH or 8-CH trigger output, 4-CH LED lighting control, 1-CH quadrature encoder, 8-CH isolated DI and DO, plus 1-CH auto measurement function for rugged machine vision and video surveillance applications.



## DAQ and Predictive Maintenance

Predictive Maintenance (PdM) techniques are used to determine when in-service equipment needs maintenance to prevent costly operational interruptions resulting from equipment failures. While preventive maintenance is characterized by routine or scheduled checks of equipment, the PdM system relies on the collection and analysis of real-time data on the conditions of the equipment. The PdM system conducts non-interference monitoring in the background, collects operational data via the use of sensors, and transmits the collected information through cloud or designated servers for the appropriate team to monitor the equipment conditions. Control center staff can use the data to build failure models and program the PdM system to recognize these failure models as a part of the machine learning process.

### Axiomtek's Solutions

Axiomtek enables predictive maintenance technology that provides valuable insights for our customers so that they can drive better business decisions. Our middleware solutions help enhance our customers' ability to quickly respond to demand spikes and emergency situations by offering visual data over the Internet of Things (IoT) and important operational alerts. Axiomtek has developed a series of industrial IoT gateway products that come with a low power consumption Intel® processor and robust edge computing power. Our industrial IoT gateway devices feature rich I/O communication interfaces, wireless connectivity, and expandable designs. They are user-friendly, cost-effective, and reliable solutions for smart IIoT use.

We provide a well-defined middleware and software development kit (SDK) for developers to easily connect equipment and sensors to gather data. We also offer software that controls system monitoring and alerts. Our cloud-ready solutions are IoT-enabled and are designed to help reduce our customer's development time and effort.



IRU152

To gain as much information as possible, the IRU152, which supports four AI channels at 16-bit, 250 kS/s, offers a communication platform that allows vibration and sound sensors to transmit data for analysis in smart factory, machine conditioning and intelligent production applications. The IRU152 can withstand an extended operating temperature range of -40°C to +70°C and up to 2G of vibration for operation in harsh environments. Furthermore, it supports the NI LabVIEW to distribute front-end sensor agent.



IPC962-512

The IPC962-512-FL adopts an innovative modular design for easy customization and scalability based on customer needs. It is powered by the 7th/6th generation Intel® Core™ and Celeron® processors (codename: Kaby Lake/Skylake) with the Intel® Q170 chipset. It is equipped with dual DDR4-2133 SO-DIMM slots with up to 32GB system memory, offering great configuration choices and expandability to meet the diverse needs across a broad range of sectors. To deliver easy and quick deployment, the IPC962-512-FL has two swappable 2.5" HDD trays that are available for extensive storage needs. Its dual expansion slots and a variety of I/O ports allow system developers to add a diverse range of peripherals according to their demands. The IPC962-512-FL is targeted specifically at applications requiring high ruggedness and high flexibility under mission-critical environments.



ICO500-518

The rolling mill is one of the key utilities for industrial automation and is difficult to monitor accurately using conventional methods. With its modular design the ICO500-518 can expand its I/O for extensive rolling mill status collection, allowing users to connect sensors with ADC to the ICO500-518. The ICO500-518 also adopts the high-performance Intel Core i platform for users to log and analyze immense amounts of data. To accelerate data analysis, Axiomtek provides an AMS tool fully compatible with the ICO500-518, which gives users the ability to manage data and build the best model to optimize rolling mill operation and predict future maintenance needs, providing a more accurate and efficient way for the rolling mill application.



## Steel Plant Operations

In the metalworking industry, "rolling" is a necessary process for metal forming. A rolling mill plays a pivotal role in the process of influencing metal production quality. The factors that can affect the operations of a rolling mill include vibration, balancing, bearing smoothness, lubricating oil temperature, and the pressure of the oil hydraulic press. Predictive maintenance is key to maximizing uptime and increased efficiency. During a rolling mill application, the PdM system collects and monitors data from the sensors mounted onto a rolling mill, which can include accelerometers, thermometers, and pressure gauges. By reading and analyzing data from the sensors, users can ensure the mill's optimum performance and prevent potential failures. The machine learning algorithm can offer a way to improve efficiency and product quality.



## CNC Machine Operations

Computer numerical control (CNC) is an automation of machine tools using computers to control machine commands. CNC machine is used for precision machining processes such as cutting, sanding, and drilling. Tools that can be controlled by the CNC process include mills, lathes, and grinders. Predictive maintenance of CNC machines involves the collection of data via the use of sensors to review a variety of machine elements such as balance of platforms, damage to bearing, wear levels of drills, etc. By reading data sent by the sensors, users can access the operational conditions of the CNC machine. The back-end platform of the PdM system evaluates which part of the machine needs service or repair, then provides maintenance recommendations for advanced maintenance required or replacement of the affected parts.

## Robotic Arm Management

A robotic arm is a mechanical arm designed to simulate the functions of a human arm. It can be programmed to accurately perform different combinations of motions carried out by a robotic arm's joints and bearings such as rotating, shifting, and gripping. A variety of robotic arm motions must be monitored, calibrated, and adjusted for the accuracy of movements. The PdM system can help prevent costly loss of productivity from unexpected machine breakdowns through the use of sensors attached to the arm. They can detect vibrations, jitters, and other deviations from the normal machine's standards and allow for advanced maintenance and uninterrupted operations.





## Smart Bus

For transportation authorities regulating public transit and traffic, reducing risks associated with driving and commuting to ensure the safety of the general public is a top priority. Governments of the major cities worldwide have been injecting enormous funds into new technologies, aiming to optimize transportation infrastructure and bolster public security for a huge population traveling daily between work, school, and home. With increased incorporation of intelligent embedded solutions into transportation facilities, transport authorities are now able to launch more initiatives to better protect the lives and properties of drivers, passengers and pedestrians. Deployment of bus surveillance presents an excellent example in this regard, demonstrating how a successful model driven by innovative technologies has improved not just the efficiency of mass transit operation, but the security of public transportation as well.

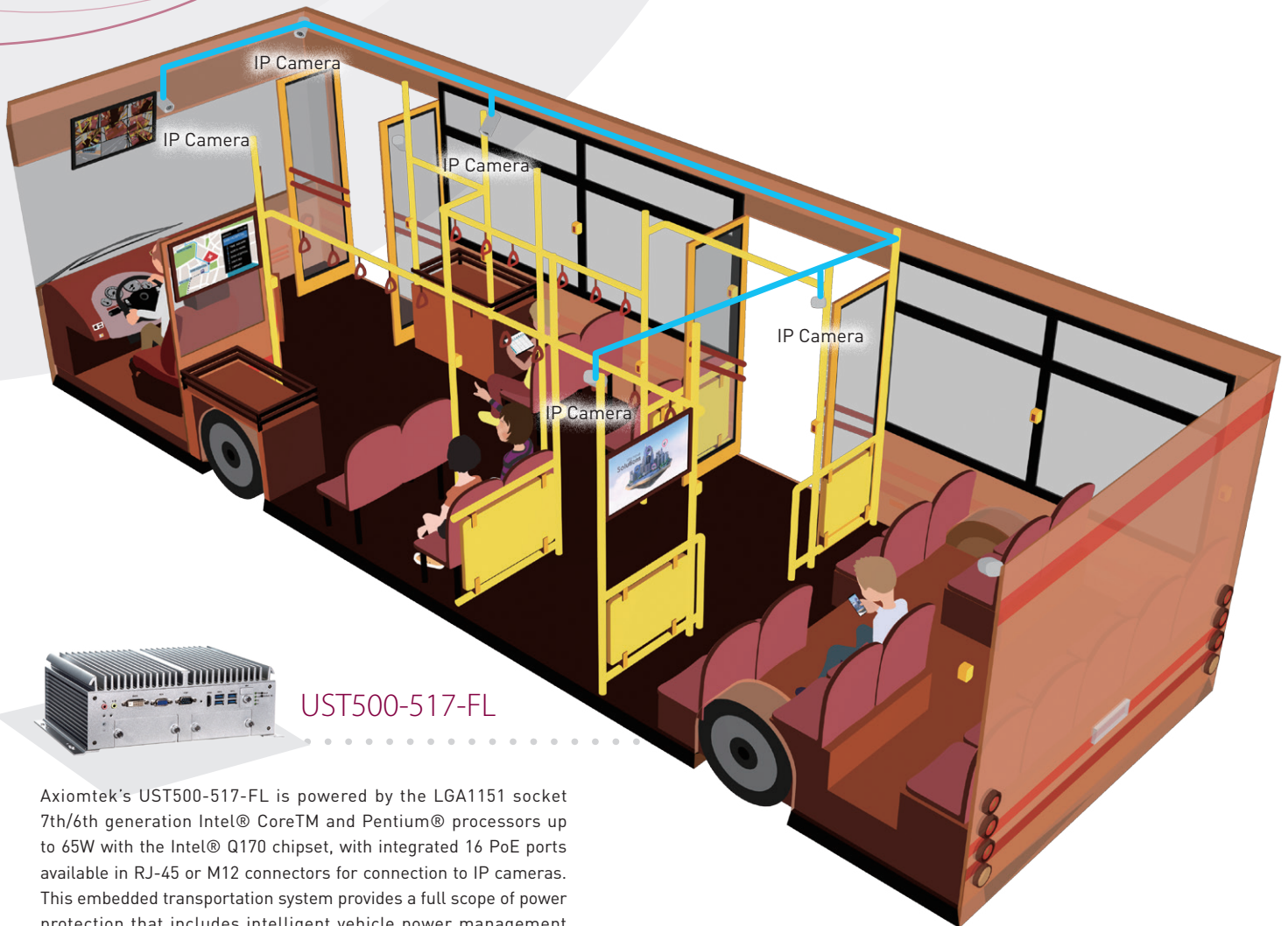

UST500-517-FL

Axiomtek's UST500-517-FL is powered by the LGA1151 socket 7th/6th generation Intel® Core™ and Pentium® processors up to 65W with the Intel® Q170 chipset, with integrated 16 PoE ports available in RJ-45 or M12 connectors for connection to IP cameras. This embedded transportation system provides a full scope of power protection that includes intelligent vehicle power management technology for ACC on/off delay, shutdown delay, and over/under voltage protection. The system is also in compliance with E-Mark and EN 50155 for mobile surveillance applications.



## CCTV Surveillance

With years of dedication to the development of innovative transportation technologies as well as continuous collaboration with its partners, Axiomtek has launched a series of embedded system solutions to facilitate the implementation of mission critical projects for public transportation security and safety.

Unlike indoor deployment, when it comes to implementing CCTV surveillance in vehicles, a variety of tough on-board situations must be considered, such as vibration, extreme temperatures and potential interference with surrounding electronics. Axiomtek offers a certified NVR system with great endurance to help overcome these challenges specific to the on-board environment, delivering stable and reliable NVR functionality to monitor and record vehicle activity.

According to a field application survey, the features that come with Axiomtek's certified products, including driver's live-view monitors, wireless communication and NVR, are not only able to alert drivers to potential dangers and help them build proper driving behavior, but also significantly improve their user experience with minimum maintenance cost, ultimately elevating driving safety for both drivers and passengers.



## Passenger Information System & Fleet Management

Helping passengers find the information they need with the least time and effort is among the list of priorities for public transportation companies. An integrated and real-time information sharing platform can fulfill such needs by delivering rich and correct information to passengers. Axiomtek is also offering on-board platforms, display monitors and station solutions. Through the use of a certified and reliable platform with GPS and wireless connection capabilities, each single transportation utility can communicate with each other and with the control center. The platform can display real-time scheduling and destination information to passengers, assisting them in obtaining the right information within a short period of time. It also allows transportation companies to cut down on information/passenger assistance manpower.

By Leveraging Axiomtek's transportation-certified system, transportation operation companies can adjust their fleet arrangements during peak times, reduce passenger wait time and enhance transportation utility efficiency, making the communication-based system an ideal solution for fleet management.



Leveraging with such system that transportation operation companies may adjust their fleet arrangement on a peak time, reducing passenger wait time and enhance the efficiency of transportation utility, with wireless and GPS function may connect with each vehicle utility, Axiomtek offers a certified and reliable platform for a communication-base and contribute a complete fleet management solution.



tBOX500-510-FL

Axiomtek's tBOX500-510-FL is certified by E-Mark, ISO 7637-2, EN 50155, EN 50121, DNV 2.4, EN 45545-2 and IEC 60945. It comes with the onboard 7th generation Intel® Core™ or Intel® Celeron® processor 3965U and offers nine different types of value-added modules (VAMs) for selection, making it a highly flexible system that can be used in a wide range of applications. The user can choose a suitable VAM to customize their system for specific needs. Furthermore, the unit features three full-sized PCI Express Mini Card slots and two SIM card slots for 3G/4G, GPS, Wi-Fi, and Bluetooth connections.





# Intelligent Warehouse Management

## Integrated Manufacturing System and Human-Machine Interface (HMI)

The competitive climate in multiple sectors are driven by the rise of the Industry 4.0 phenomenon and new Internet of Things (IoT) technologies. Most manufacturers are seeking ways to enhance their competitive advantages by investing in available computer and big data technologies to automate and optimize efficiencies in all areas of their operations. The “Smart Factory” concept has been adopted in many regions throughout the world. Its key characteristic involves fully-integrated, real-time intelligent systems that can respond quickly and automatically with little or no human involvement to the changing demands, conditions and uncertainties.

Many of the following factors are considered crucial for a successful deployment of a smart factory, artificial intelligence, low latency data acquisition and transfer, contextualized data for actionable and predictive analytics, and automated production and warehouse operation for higher transparencies and efficiencies. In a smart factory, humans and machines collaborate to make the best possible decisions through cyber-physical systems (CPS) and IoT in real-time.

Axiomtek is a leading design and manufacturing company in the industrial computer and embedded field. Our focus is to deliver high quality products and services that help solve our customer's challenges in the automation industry. We provide a comprehensive line of industrial-grade HMI products for factory automation applications such as material quality management, in-process quality inspection, smart packaging and more. Our approach is to offer true customer values by designing our solutions to help enhance productivity, increase efficiency, reduce human errors and offer a higher return on investment.

## Smart Automation in Industrial Environments

Smart automation applications in challenging operational environments require smart computer solutions that are highly dependable and designed to meet the demanding conditions to ensure optimum performance and uptime. Axiomtek's industrial automation solutions are specifically designed and tested to deliver maximum reliability in harsh industrial conditions such as those with high heat and humidity level, ingress particulates, electromagnetic inference, vibration and electrostatic discharge.

## The Heavy-Duty Touch Panel Computers - the GOT300 Product Series

The GOT300 heavy-duty touch panel computer series offers wide operating temperature ranges, built-in fuses, thermal resistance and fanless designs. The solutions in this series are suitable for dusty and high moisture environments such as food factories and cold storage warehouses, steel refineries and cotton factories. All models in this series have IP65 offering protection against dirt and water. front bezels for protection against water damage. The products offer great anti-vibration designs that allow the systems to work well under 2G of vibration in operation mode. This flexible heavy-duty touch panel PC product line features choices of Intel® Core™ i7/i5/i3, Pentium® or Celeron® processors for performance scalability.



## Dependable Industrial Touch Panel Computers - the P1000 Product Series

Axiomtek's P1000 industrial touch panel computer series is designed for a variety of factory-related uses including shop floor control. The products provide manufacturers with operational transparency, high level of control and real-time monitoring of shop floor. All of its important data, including materials status, machine usage, productivity level, waste generated and resources status can be captured, transferred, analyzed, reported and accessed at shop floor level. This helps provide higher operational efficiency and allows for faster and better decision making process.

The P1000 product series is highly flexible. It offers a comprehensive range of options to serve a variety of applications from basic to high performance solution needs. It comes in various sizes, CPU choices, extensive options for expansion and more. The P1000 solutions deliver a great combination of versatility, quality and overall value for demanding industrial applications.

## Feature-Rich HMI - the GOT5000 and GOT100 Product Series

Axiomtek understands the industry needs for industrial computer solutions that are rich with purpose-built features aimed at optimizing their designed functionalities. In addition to performance, the heightened demands for secured manufacturing environments are also a critical factor for a factory or warehouse operational success. An example of our GOT5000 products that serve the aforementioned needs is the GOT5103W-845. It offers interfaces that allow for integration with an RFID module and door security software to support facility security control and management. This touch panel computer can be integrated with cameras for surveillance purposes. It can also be used to monitor electricity consumption in the factory via the use of DIO ports for analytics and efficiency improvements.

## Vision Gateway System - the ICO Product Series

The ICO product line offers many options for applications such as gateway, edge control system and vision control system. An example of a good system for vision inspection and surveillance is the ICO320. With its PoE port and PoE management tool offered by Axiomtek, the ICO320 can be easily connected to cameras to capture video images. Axiomtek's proprietary Agent Maas Suite software (AMS) is designed as a complete solution for the ICO's data management and device health monitoring. Users can capture and transfer sensor data to cloud for analytics and improvements. This deployment-ready solution provides a quick, simple and reliable way to create an effective IIoT system. It is suitable for a variety of smart factory applications including vision inspection and factory surveillance.

## The Forklift Application - the GOT600 Product Series

The GOT600 series products offer features that help streamline warehouse operations. Our industrial touch panel computers have made human-machine interactions more efficient, helped eliminate most picking and fulfillment errors, and improved product traceability and overall productivity.

Our GOT600 products have served the needs of operations that required forklift use. They were implemented to help collect data from forklifts operating in the field and transfer it back to a data center near real-time. The GOT600 products offer the level of dependability and flexibility that are much needed by the both operation managers and forklift operators. Their ruggedized and purpose-built features such as wide operating temperature and power input ranges, auto dimming and high brightness made them the right choice for applications that require a good combination of ruggedness, performance and reliability indoor or outdoor.







## Intelligent Retail

To remain competitive in the ever-changing retail climates, retail businesses have shifted their focus to deliver consistent, seamless positive shopping experiences through the use of technology in support of their omni-channel retailing strategies. Investments are being made by major retailers with the main goals of improving their understanding of consumer buying behavior, product and service offerings, customer buying experience and ultimately, enhanced profitability and long-term brand loyalty. Axiomtek's retail solutions are designed to support the retail industry's quest to be the best in class. Our advanced, feature-rich, easy-to-deploy retail computer products are formulated for cutting edge retail applications.

### Solutions for Hypermarket Stores/Shopping Malls

#### Interactive Digital Signage System

Large interactive digital signage and captivating content are the best tools for product promotions and customer assistance. These in-store signage displays can also support numerous media formats and serve as bulletin boards for broadcasting the latest store news and event information. They can offer relevant event news and special store-wide promotions to increase brand loyalty. Axiomtek's OPS and SDM digital signage products are made to serve retailers' variety of interactive digital signage needs. They are scalable, support high computing and graphics performance and are available in various specifications with interfaces built for streamlined installation and maintenance. These products are made to last. They are built to deliver true customer value and low long-term cost of ownership.

#### Intelligent Shopping Cart (Smart Cart) with a Tablet/Panel PC

Axiomtek's tablet solution can be built into a shopping cart and turn the cart into an intelligent personal shopping assistant to help customers with everyday shopping tasks. The tablet's GPS and Wi-Fi capabilities allow shoppers to search for products inside a grocery store and quickly locate the products with the navigation feature as they shop. The smart cart makes grocery shopping easier and faster than ever before.

#### Interactive Kiosk System/Panel PC

Interactive kiosks and appealing digital content are the best tools for product promotions and customer assistance. Retailers can now easily deliver relevant multimedia images and messages to their customers through the use of a smart kiosk system. These interactive kiosks can serve many useful purposes. It can help provide customers with an abundance of useful pertinent information about their products of interest. For example, special discounts, product 3-D imagery, availability, in-store location and product reviews help customers save their time, learn about the products and services, and make effective decisions on their purchases.

Axiomtek's motherboards, embedded systems and panel computers are designed for kiosk integration and uses ranging from delivering simple product information to more complex tasks - data capture for analytics and real-time delivery of interactive content based on past buying histories and demographics. Our wide range of products offer versatility, rich features, uncompromised quality and exceptional reliability. They are designed for fast deployment and have been selected for various kiosk applications.

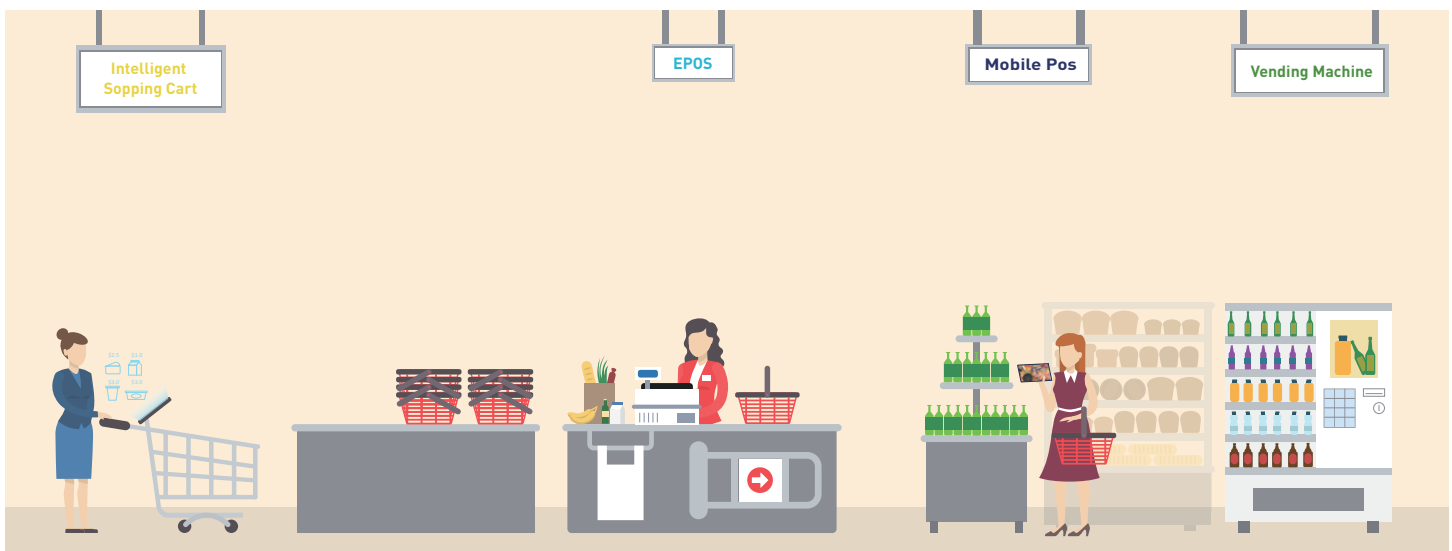

### Self-Checkout System

A customer's in-store experience rating often comes down to a few crucial considerations – one being the speed and ease of their check-out process. It is one of the most important factors influencing a retailer's success. Self-checkout terminals offer a simple and quick option for those who do not need personal assistance during the payment process. It can drastically reduce wait time and enhance customer satisfaction. Axiomtek's computers have been used to control and manage the features and overall operation of self-checkout systems. They are equipped with the latest Intel® Core™ processors to ensure fast processing time and good and reliable performance. Our products offer high compatibility levels with various digital signage/content management software and deliver rich functionalities to the retailers that can be translated into better self-checkout experience for their customers.

## Solutions for Small Stores/Quick Service Restaurants (QSRs)/Customer Service (CS)

### Mobile Point of Sales (POS)

A mobile POS usually involves the use of a smartphone tablet or dedicated wireless device that performs the functions of a cash register or electronic point of sale terminal (ePOS). Store staff can use a mobile POS to engage with and provide assistance to customers from anywhere in the store instead of being tied to the cash register. The mobile POS system can not only perform checkout functions, but it also can be integrated with digital signage management technology and an inventory system. With such access to information readily available at the store staff's fingertips, they are equipped to provide answers, recommendations and solutions to satisfy the customer's needs. Mobile POS systems can significantly optimize store operational efficiency. They can help increase customer engagement level and reinforce purchasing decisions. Axiomtek's mobile tablet solutions can help retailers enhance their competitive advantages over their competitors.

### Improved, Advanced Vending Machine

Unlike a traditional vending machine which often fails to draw much attention from consumers, the next generation of vending machines has adopted an interactive digital signage platform that is capable of displaying eye-catching advertising content as well as customized key messages directly to the customers to encourage more sales. Through the integration and implementation of Axiomtek's smart digital signage solutions, these vending machines can help boost sales revenues while creating an additional source of income through advertising.

### Electronic Point of Sale (EPOS) System

Axiomtek's intelligent EPOS solutions are customized for a variety of service needs - from payment processing, transaction verification, inventory update, sales report and more. Our EPOS products come with a comprehensive line of motherboards ready for customization and integration. Our teams offer personalized design engineering and value-added services that have helped our customers effectively deploy a wide range of self-service machines, POS systems, tablets, etc.

### ATM System

There is a rising demand in the financial and banking sectors for ATM solutions that can help increase revenues, reduce operating costs, manage risks and deliver better self-service banking experiences. Axiomtek is committed to developing innovative financial solutions that meet the rising needs of both financial institutions and independent ATM deployers. Our ATM solutions are delivered with high levels of expertise. We customize the system to target marketing opportunities associated with the financial institution's use of their ATM machines while fulfilling the need of their multi-output design requirements.

### Customizable Design on Multi-Retail Systems/Solutions

In order to assist our retail customer's increasingly complex needs and demands for highly reliable intelligent solutions, Axiomtek offers both board-level and system-level design and integration services to help our retail customers achieve their goals. Our experienced and disciplined engineering team and resources allow us to stay ahead of our competitors with a short product development cycle and exceptional deliverable quality.





# Table of Contents

## Boards and Modules

### 1 System on Modules

---

Selection Guide		39
<b>COM Express</b>		
CEM310	COM Express Type 10 Mini Module with Intel® Atom® x5 and x7 Processor	41
CEM312	COM Express Type 6 Compact Module with Intel® Atom® x5 and x7 Processor	42
CEM511	COM Express Type 6 Compact Module with 7th Gen Intel® Core™ & Celeron® Processor	43
<b>NEW</b> CEM700	COM Express Type 7 Basic Module with Intel® Xeon® D-1500 & Pentium® Processor D1500	44
<b>NEW</b> CEB94017	COM Express Type 10 Development Baseboard	45
CEB94018	COM Express Type 10 Mini Application Board with LVDS, VGA, Dual LANs and Audio	46
CEB94021	COM Express Type 6 Application Board with LVDS, VGA, DDI, Dual LANs and Audio	47
<b>NEW</b> CEB94701	COM Express Type 7 Development Baseboard	48
<b>Qseven</b>		
Q7M310	Qseven Module with Intel® Atom® x5 and x7 Processor	49
Q7B301	Qseven Module Rev 2.1 Application Board with LVDS, HDMI, Dual LANs and Audio	50

### 2 3.5" Embedded Boards

---

Selection Guide		53
<b>NEW</b> CAPA84R	3.5" Embedded SBC with Intel® Celeron® Processor J1900/J1800, LVDS, VGA, DisplayPort, 3 GbE LANs and Audio	55
CAPA500	3.5" Embedded SBC with LGA1151 Socket for 7th/6th Gen Intel® Core™ i7/i5/i3 Processor, LVDS, VGA, HDMI, 2 GbE LANs and Audio	56
<b>NEW</b> CAPA310	3.5" Embedded SBC with Intel® Atom® x5-E3940 Processor, LVDS, HDMI, 2 GbE LANs and Audio	57
CAPA313	3.5" Embedded SBC with Intel® Pentium® Processor N4200 & Celeron® Processor N3350, LVDS, HDMI, 2 GbE LANs and Audio	58
<b>NEW</b> CAPA315	3.5" Embedded SBC with Intel® Pentium® Processor N4200 & Celeron® Processor N3350, eDP, 2 HDMI, 2 GbE LANs and Audio	59



## 3 Pico-ITX SBCs

---

	Selection Guide	61
	PIC051R Pico-ITX SBC with 7th Generation Intel® Core™ i7/i5/i3 and Celeron® processor, DisplayPort, LVDS and 2 GbE LANs	62
	PIC0316 Pico-ITX SBC with Intel® Pentium® Processor N4200 & Celeron® Processor N3350, HDMI, LVDS, GbE LAN and Audio	63
	PIC0318 Pico-ITX SBC with Intel® Pentium® Processor N4200 & Celeron® Processor N3350, DisplayPort, LVDS, 2 GbE LANs and Audio	64
	PIC0319 Pico-ITX SBC with Intel® Atom® x5-E3940 Processor, DisplayPort, LVDS, 2 GbE LANs and Audio	65



## 4 Mini-ITX Motherboards

---

	Selection Guide	67
	MAN0310 Mini-ITX SBC with Intel® Celeron® Processor N3350 & Pentium® Processor N4200, VGA, HDMI, LVDS, USB 3.0, PCI Express Mini Card Slot, M.2, and HD Audio	69
	MAN0311 Thin Mini-ITX SBC with Intel® Celeron® Processor N3350, Dual HDMI, LVDS, USB 3.0, PCI Express Mini Card, mSATA and HD Audio	70
	MAN0315 Mini-ITX SBC with Intel® Celeron® Processor J3355, VGA, HDMI, USB 3.0, PCI Express Mini Card Slot, mSATA and HD Audio	71
	MAN0520 Mini-ITX SBC with LGA1151 8th Gen Intel® Core™ i7/i5/i3 Processor, Dual DisplayPort++, HDMI, LVDS, USB 3.0, mSATA, M.2 and HD Audio	72
	MAN0521 Thin Mini-ITX SBC with LGA1151 8th Gen Intel® Core™ i7/i5/i3 Processor, DisplayPort++, HDMI, LVDS, VGA, USB 3.0, M.2 and HD Audio	73

## 5 ATX & Micro ATX Motherboards

---

	Selection Guide	75
	IMB500 ATX Motherboard with LGA1151 Socket 7th/6th Gen Intel® Core™ Processor, Intel® Q170, USB 3.0, SATA 3.0, Dual LANs, VGA, DisplayPort, HDMI and mSATA	78
	IMB501 ATX Motherboard with LGA1151 Socket 7th/6th Gen Intel® Core™ Processor, Intel® H110, USB 3.0, SATA 3.0, Dual LANs, VGA, DisplayPort, HDMI and mSATA	79
	IMB502 ATX Motherboard with LGA1151 Socket 7th/6th Gen Intel® Core™ Processor, Intel® Q170, USB 3.0, SATA 3.0, Dual LANs, VGA, DVI-D and HDMI	80
	IMB520 ATX Motherboard with LGA1151 Socket 8th Gen Intel® Core™ Processor, Intel® Q370, USB 3.1 Gen2, SATA 3.0, Dual LANs, VGA, DP, DVI-D, and HDMI	81
	IMB521 ATX Motherboard with LGA1151 Socket 8th Gen Intel® Core™ Processor, Intel® C246, ECC DDR4, USB 3.0, SATA 3.0, Dual LANs, VGA, DP, DVI-D, and HDMI	82
	IMB523 ATX Motherboard with LGA1151 Socket 8th Gen Intel® Core™ Processor, Intel® Q370, USB 3.1 Gen2, SATA 3.0, Dual LANs, VGA, DP, DVI-D, and HDMI	83



<b>NEW</b>	IMB524	ATX Motherboard with LGA1151 Socket 8th Gen Intel® Core™ Processor, Intel® H310, USB 3.1 Gen1, SATA 3.0, Dual LANs VGA, DP, DVI-D, and HDMI	84
<b>NEW</b>	IMB525	ATX Motherboard with LGA1151 Socket 8th Gen Intel® Core™ Processor, Intel® C246, ECC DDR4, USB 3.1 Gen, SATA 3.0, Dual LANs, VGA, DP, DVI-D, and HDMI	85
	IMB210	ATX Motherboard with LGA1150 Socket Intel® Xeon® E3-v3 Processor, Intel® C226, ECC DDR3, USB 3.0, SATA 3.0, Dual LANs, DisplayPort, DVI-I, HDMI and CFast™	86
	IMB211	ATX Motherboard with LGA1150 Socket 4th Gen Intel® Core™ Processor, Intel® Q87, USB 3.0, SATA 3.0, Dual LANs, DisplayPort, VGA, HDMI and mSATA	87
	MMB501	Micro ATX Motherboard with LGA1151 Socket 7th/6th Gen Intel® Core™ Processor, Intel® Q170, USB 3.0, SATA 3.0, Dual LANs VGA, DP, DVI-D, and HDMI	88

## 6 Slot CPU Cards

	Selection Guide		91
	SHB130	PICMG 1.3 Full-size CPU Card with LGA1150 4th Gen Intel® Core™ i7/i5/i3 Processor, Intel® Q87, SATA3, USB 3.0, DVI-D, VGA, DisplayPort and Dual LANs	93
	SHB131	PICMG 1.3 Full-size CPU Card with 4th Gen Intel® Core™ i7/i5 & Celeron® U-series Processor, SATA3, USB 3.0, Dual LANs and Dual DVI-D	94
	SHB140	PICMG 1.3 Full-size CPU Card with LGA1151 7th/6th Gen Intel® Core™ Processor, Intel® Q170/H110, SATA3, USB 3.0, Dual LANs and DVI-I	95
<b>NEW</b>	SHB150	PICMG 1.3 Full-size CPU Card with LGA1151 8th Gen Intel® Core™ Processor, Intel® C246/Q370/H310, SATA3, USB 3.1 Gen1/Gen2, Dual LANs and DVI-I	96

## 7 Smart Display Module

	Selection Guide		99
<b>NEW</b>	SDM300S	Intel® Smart Display Module Small (SDM-S) with Intel® Pentium® Processor N4200 & Celeron® Processor N3350	100

## 8 PCI Express Cards

	<b>Machine Vision</b>		
<b>NEW</b>	AX92320	4-port PCI Express GigE Frame Grabber Card	103
<b>NEW</b>	AX32350	Real-Time Vision I/O Card	104
	<b>Data Acquisition [DAQ]</b>		
<b>NEW</b>	AX92351	32-CH Isolated Digital I/O PCI Express Card with Digital Filter	105

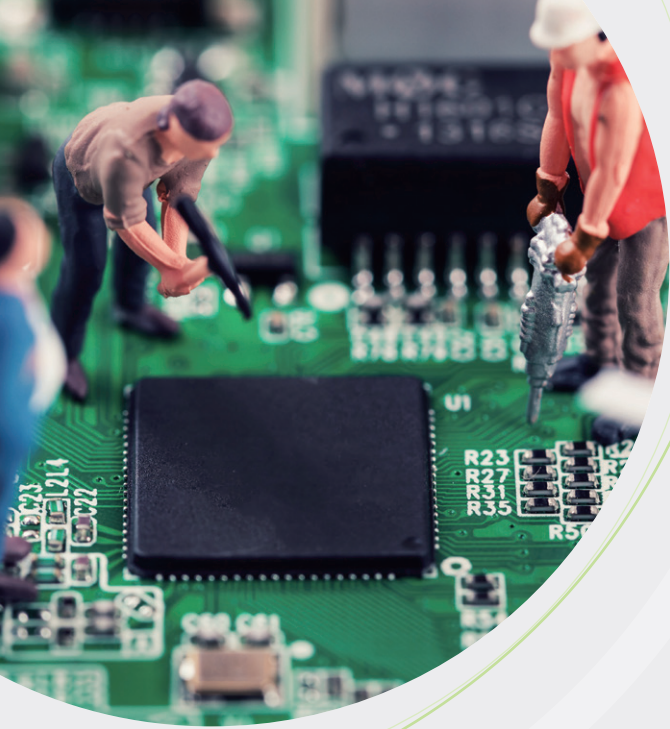

System on Modules

3.5" Embedded Boards

Pico-ITX SBCs

Mini-ITX Motherboards

ATX/Mirco ATX Motherboards

Slot CPU Cards

Smart Display Module

PCI Express Cards

# Boards and Modules

# 1

## System on Modules

Axiomtek's SoM (System on Module) solution includes COM Express module (CEM) and Qseven module. In conjunction with a suitable baseboard, Axiomtek's SoM solution is an optimal solution for embedded applications to fulfill the various vertical applications that SBC (Single Board Computer) usually cannot satisfy. SoM is designed with all necessary components, offering the most update interface and excellent computing performance to reduce TCO (Total Cost of Ownership) and improve time to market.

Selection Guide		39
<b>COM Express</b>		
CEM310	COM Express Type 10 Mini Module with Intel® Atom® x5 and x7 Processor	41
CEM312	COM Express Type 6 Compact Module with Intel® Atom® x5 and x7 Processor	42
CEM511	COM Express Type 6 Compact Module with 7th Gen Intel® Core™ & Celeron® Processor	43
<b>NEW</b> CEM700	COM Express Type 7 Basic Module with Intel® Xeon® D-1500 & Pentium® Processor D1500	44
<b>NEW</b> CEB94017	COM Express Type 10 Development Baseboard	45
CEB94018	COM Express Type 10 Mini Application Board with LVDS, VGA, Dual LANs and Audio	46
CEB94021	COM Express Type 6 Application Board with LVDS, VGA, DDI, Dual LANs and Audio	47
<b>NEW</b> CEB94701	COM Express Type 7 Development Baseboard	48
<b>Qseven</b>		
Q7M310	Qseven Module with Intel® Atom® x5 and x7 Processor	49
Q7B301	Qseven Module Rev 2.1 Application Board with LVDS, HDMI, Dual LANs and Audio	50

# System on Modules

## Selection Guide

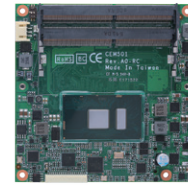
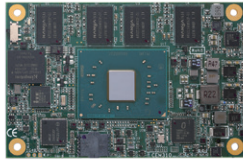

Features/Models	CEM310	CEM312	CEM511
<b>Form Factor</b>	COM Express® Type 10 Mini	COM Express® Type 6 Compact	COM Express® Type 6 Compact
<b>CPU Level</b>	Intel® Atom® x5/x7	Intel® Atom® x5/x7	7th gen Intel® Core™ i7/i5/i3
<b>CPU</b>	Onboard	Onboard	Onboard
<b>CPU FSB Frequency</b>	N/A	N/A	N/A
<b>Core Logic Chipset</b>	SoC integrated	SoC integrated	SoC integrated
<b>Memory Type</b>	DDR3L-1600	DDR3L-1600	DDR4-2133
<b>Max. DRAM Capacity</b>	4GB (standard)/8GB (optional)	8GB	32GB
<b>Cache RAM Capacity</b>	SoC integrated	SoC integrated	SoC integrated
<b>BIOS</b>	AMI UEFI BIOS (Legacy Free)	AMI UEFI BIOS (Legacy Free)	AMI UEFI BIOS (Legacy Free)
<b>Watchdog Timer</b>	65536 levels, 0 to 65535 sec.	65536 levels, 0 to 65535 sec.	65536 levels, 0 to 65535 sec.
<b>Onboard Storage</b>	eMMC 5.0 up to 64GB (optional)	eMMC 5.0 up to 64GB (optional)	N/A
<b>Onboard GPIO</b>	4-in/4-out	4-in/4-out	4-in/4-out (SDIO optional)
<b>I/O</b>			
<b>IDE</b>	N/A	N/A	N/A
<b>SATA</b>	2 x SATA-600	2 x SATA-600	3 x SATA-600
<b>TPM</b>	N/A	TPM 1.2 (optional)	TPM 1.2
<b>Serial</b>			
<b>COM 1</b>	TX/RX	TX/RX	TX/RX
<b>COM 2</b>	TX/RX	TX/RX	TX/RX
<b>COM 3</b>	N/A	N/A	N/A
<b>COM 4</b>	N/A	N/A	N/A
<b>USB</b>	2 x USB 3.0 8 x USB 2.0	4 x USB 3.0 8 x USB 2.0	4 x USB 3.0 8 x USB 2.0
<b>Display</b>	1 x DDI 1 x LVDS (eDP optional)	2 x DDI 1 x LVDS (eDP optional) 1 x VGA (optional)	2 x DDI 1 x LVDS (eDP optional) 1 x VGA (optional)
<b>Ethernet</b>	1 x 10/100/1000 Mbps Ethernet	1 x 10/100/1000 Mbps Ethernet	1 x 10/100/1000 Mbps Ethernet
<b>Audio</b>	Codec on baseboard	Codec on baseboard	Codec on baseboard
<b>Hardware Monitoring</b>	Yes	Yes	Yes
<b>SMBus</b>	Yes	Yes	Yes
<b>Expansion Interface</b>	Max. PCIe with 4 lanes	Max. PCIe with 4 lanes	PCIe with 6 lanes
<b>Power Management</b>	ACPI	ACPI	ACPI
<b>Operating Temperature</b>	-40°C to +85°C (-40°F to +185°F) -20°C to +70°C (-4°F to +158°F)	-40°C to +85°C (-40°F to +185°F)	-40°C to +85°C (-40°F to +185°F)
<b>Relative Humidity</b>	10% to 95%, non-condensing	10% to 95%, non-condensing	10% to 95%, non-condensing
<b>EMI Compliance</b>	CE	CE	CE

NEW

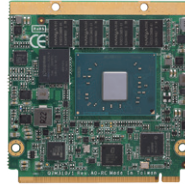

Features/Models	CEM700	Q7M310
<b>Form Factor</b>	COM Express® Type 7 Basic	Qseven
<b>CPU Level</b>	Intel® Xeon® D-1577 1.3/2.1GHz 24MB, 45W (16C) Intel® Xeon® D-1539 1.6/2.2GHz 12MB, 35W (8C) Intel® Xeon® D-1548 2.0/2.6GHz 12MB, 45W (8C) Intel® Xeon® D-1527 2.2/2.7GHz 6MB, 35W (4C) Intel® Pentium® D1519 1.5/2.1GHz 6MB, 25W (4C) Intel® Pentium® D1508 2.2/2.6GHz 3MB, 25W (2C)	Intel® Atom® x5/x7
<b>CPU</b>	Onboard	Onboard
<b>CPU FSB Frequency</b>	N/A	N/A
<b>Core Logic Chipset</b>	SoC integrated	SoC integrated
<b>Memory Type</b>	DDR4-2400	DDR3L-1600
<b>Max. DRAM Capacity</b>	32GB	4GB (standard)/8GB (optional)
<b>Cache RAM Capacity</b>	SoC integrated	SoC integrated
<b>BIOS</b>	AMI UEFI BIOS (Legacy Free)	AMI UEFI BIOS (Legacy Free)
<b>Watchdog Timer</b>	65536 levels, 0 to 65535 sec.	65536 levels, 0 to 65535 sec.
<b>Onboard SSD</b>	N/A	eMMC 5.0 up to 64GB (optional)
<b>Onboard GPIO</b>	4-in/4-out	4-in/4-out
<b>I/O</b>		
<b>IDE</b>	N/A	N/A
<b>SATA</b>	2 x SATA-600	2 x SATA-600
<b>TPM</b>	TPM 2.0	NA
<b>Serial</b>		
<b>COM 1</b>	TX/RX	TX/RX
<b>COM 2</b>	TX/RX	N/A
<b>COM 3</b>	N/A	N/A
<b>COM 4</b>	N/A	N/A
<b>USB</b>	4 x USB 3.0 4 x USB 2.0	2 x USB 3.0 4 x USB 2.0
<b>Display</b>	N/A	1 x DDI 1 x LVDS (eDP optional)
<b>Ethernet</b>	1 x 10/100/1000 Mbps Ethernet 2 x 10G Base KR interfaces support NCSI	1 x 10/100/1000 Mbps Ethernet
<b>Audio</b>	Codec on baseboard	Codec on baseboard
<b>Hardware Monitoring</b>	Yes	Yes
<b>SMBus</b>	Yes	Yes
<b>Expansion Interface</b>	1 x PCIe x16 Gen3 (8GT/s) configurable (1 x16, 2 x 8, 1 x 8+2 x 4, 2 x 4+1 x 8, 4 x 4) 1 x PCIe x8 Gen3 (8GT/s) configurable (1x8, 2x4) 1 x PCIe x8 Gen2 (5GT/s); (PCIe lane 7 is supported by build option, in place of GbE )	PCIe with 4 lanes
<b>Power Management</b>	ACPI	ACPI
<b>Operating Temperature</b>	-20°C to +70°C (-4°F to +158°F) -40°C to +85°C (-40°F to +185°F)	-20°C to +70°C (-4°F to +158°F) -40°C to +85°C (-40°F to +185°F)
<b>Relative Humidity</b>	10% to 95%, non-condensing	10% to 95%, non-condensing
<b>EMI Compliance</b>	CE	CE

System on Modules

- 1
- 2
- 3
- 4
- 5
- 6
- 7
- 8



# CEM310

COM Express Type 10 Mini Module with Intel® Atom® x5 and x7 Processor

## Features

- Intel® Atom® x5 and x7 processors (Apollo Lake)
- Onboard 4GB DDR3L memory (8GB optional)
- Max. up to 4 lanes of PCI Express
- 2 SATA-600
- 2 USB 3.0 and 8 USB 2.0



## Core System

CPU	Intel® Atom® x7-E3950 (2.0 GHz) Intel® Atom® x5-E3940 (1.8 GHz) Intel® Atom® x5-E3930 (1.8 GHz)
System Memory	4GB DDR3L memory onboard, up to 8GB (optional)
Chipset	SoC integrated
BIOS	AMI UEFI BIOS (Legacy Free)
SSD	eMMC 5.0 up to 64GB (optional)
Watchdog Timer	65536 levels, 0 to 65535 sec.
Expansion Interface	4 x PCIe x1 (3 x1 while internal LAN is connected)
Battery Lithium	N/A
Power Input	ATX: +12V, +5VSB AT: +12V Wide range input: +4.75V to +20V
Dimensions	84 x 55 mm
Board Thickness	2.0 mm
Operating Temperature	Industrial: -40°C to +85°C (-40°F to +185°F) Standard: -20°C to +70°C (-4°F to +158°F)
Humidity	10% to 95% relative humidity, non-condensing
Vibration Endurance	3.5 Grms

## I/O

SATA	2 x SATA-600
Hardware Monitoring	Yes
Ethernet	1 x 10/100/1000 Mbps Ethernet with Intel® i210-IT; supports Wake-on-LAN, PXE Boot ROM
Audio	HD link interface to baseboard for Codec
USB	2 x USB 3.0 8 x USB 2.0
Serial	1 x LPC 1 x SPI 2 x TX/RX
TPM	N/A
SMBus	Yes
Others	1 x I <sup>2</sup> C
GPIO	4-CH in & 4-CH out
Smart Battery	Yes

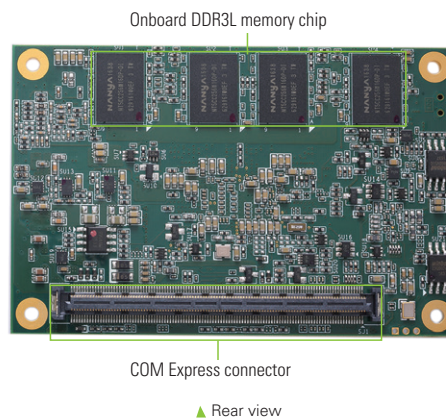
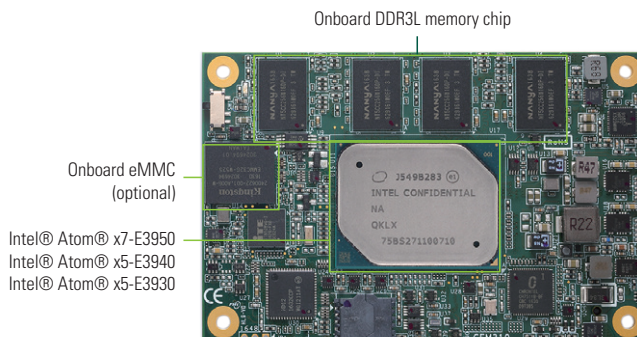

## Packing List

Chipset	Intel® Gen 9 Graphics Engine Supports Gfx – DX12.0, OCL2.0, OGL 4.3
Display Interface	1 x DDI (DP, HDMI, DVI) 1 x LVDS; 18/24-bit single channel (eDP optional)

## Packing List

Quick installation guide

## Ordering Information

Standard	
CEM310PG-E3930+4GB (Ind) (P/N: E38D310100)	COM Express Type 10 Mini module with Intel® Atom® x5-E3930, DDI, LVDS, USB 3.0 and GbE LAN (Ind. Temp)
CEM310PG-E3940+4GB (Ind) (P/N: E38D310102)	COM Express Type 10 Mini module with Intel® Atom® x5-E3940, DDI, LVDS, USB 3.0 and GbE LAN (Ind. Temp)
CEM310PG-E3950+4GB (Ind) (P/N: E38D310103)	COM Express Type 10 Mini module with Intel® Atom® x7-E3950, DDI, LVDS, USB 3.0 and GbE LAN (Ind. temp)
CEM310PG-E3930+4GB (P/N: E38D310104)	COM Express Type 10 Mini module with Intel® Atom® x5-E3930, DDI/LVDS, USB 3.0 and GbE LAN
CEM310PG-E3940+4GB (P/N: E38D310105)	COM Express Type 10 Mini module with Intel® Atom® x5-E3940, DDI, LVDS, USB 3.0 and GbE LAN
CEM310PG-E3950+4GB (P/N: E38D310106)	COM Express Type 10 Mini module with Intel® Atom® x7-E3950, DDI, LVDS, USB 3.0 and GbE LAN
Optional	
7128D310000E	CEM310 heatspreader
5078D840200E	Heatsink with fan (need to be with 7128D310000E)
CEB94017 (P/N: E394017101)	COM Express Type 10 development baseboard

# CEM312

COM Express Type 6 Compact Module with Intel® Atom® x5 and x7 Processor

## Features

- Intel® Atom® x5 and x7 processors (Apollo Lake)
- 2 DDR3L-1600 SO-DIMM for up to 8GB of memory
- Max. up to 4 lanes of PCI Express
- 2 SATA-600
- 4 USB 3.0 and 8 USB 2.0
- AXView 2.0 intelligent remote management software
- TPM 1.2 supported (optional)



### Core System

CPU	Intel® Atom® x7-E3950 (2.0 GHz) Intel® Atom® x5-E3940 (1.8 GHz) Intel® Atom® x5-E3930 (1.8 GHz)
System Memory	2 x 204-pin SO-DIMM DDR3L-1600, up to 8GB
Chipset	SoC integrated
BIOS	AMI UEFI BIOS (Legacy Free)
SSD	eMMC 5.0 64GB (optional)
Watchdog Timer	65536 levels, 0 to 65535 sec.
Expansion Interface	4 x PCIe (3 lanes while internal LAN is connected)
Battery Lithium	N/A
Power Input	ATX: 12V, +5VSB AT: 12V
Dimensions	95 x 95 mm
Board Thickness	2.0 mm
Operating Temperature	-40°C to +85°C (-40°F to +185°F)
Humidity	10% to 95% relative humidity, non-condensing
Vibration Endurance	3.5 Grms

### I/O

SATA	2 x SATA-600
Hardware Monitoring	Yes
Ethernet	1 x 10/100/1000 Mbps Ethernet with Intel® i210-IT; supports Wake-on-LAN, PXE Boot ROM
Audio	HD link interface to baseboard for Codec
USB	4 x USB 3.0 8 x USB 2.0
Serial	1 x LPC 1 x SPI 2 x TX/RX
TPM	TPM 1.2 (optional)
SMBus	Yes
Others	1 x I <sup>2</sup> C
GPIO	4-CH in & 4-CH out
Smart Battery	Yes

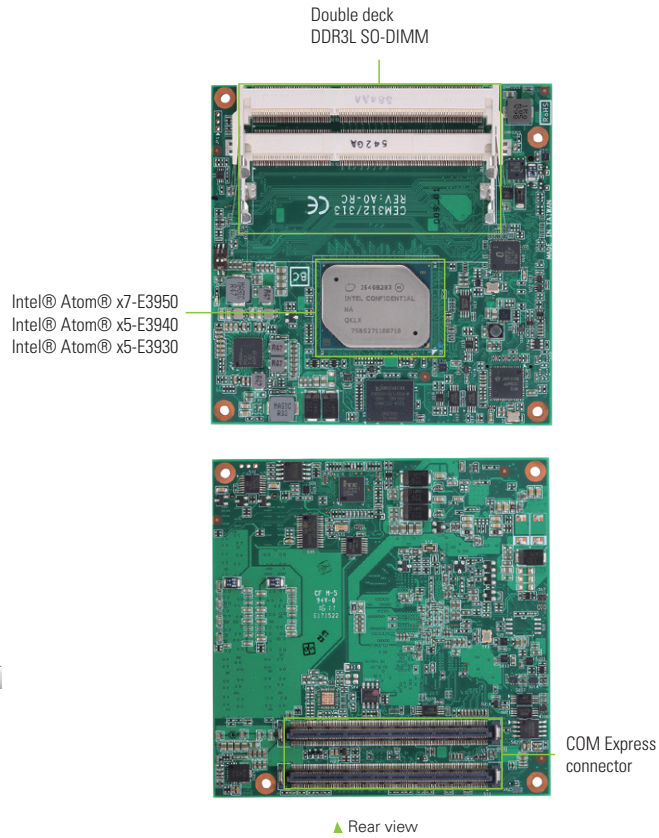

### Display

Chipset	Intel® Gen 9 Graphics Engine Supports Gfx - DX12.0, OCL 2.0, OGL 4.3
Display Interface	2 x DDI (DP, HDMI, DVI); VGA optional 1 x LVDS; 18/24-bit dual channel (eDP option)

### Packing List

Quick installation guide; user's manual/utility CD

### Ordering Information

Standard	
CEM312PG-E3950 (P/N : E38D312100)	COM Express Type 6 Compact module with Intel® Atom® x7-E3950, DDI, LVDS, USB 3.0 and GbE LAN
CEM312PG-E3940 (P/N : E38D312101)	COM Express Type 6 Compact module with Intel® Atom® x5-E3940, DDI, LVDS, USB 3.0 and GbE LAN
CEM312PG-E3930 (P/N : E38D312103)	COM Express Type 6 Compact module with Intel® Atom® x5-E3930, DDI, LVDS, USB 3.0 and GbE LAN
Optional	
CEB94011 (P/N : E394011100)	COM Express Type 6 evaluation board
7128D312000E	CEM312 heatspreader
7118D312000E	CEM312 heatsink



# CEM511

COM Express Type 6 Compact Module with 7th Gen Intel® Core™ & Celeron® Processor

## Features

- 7th gen Intel® Core™ i7/i5/i3 and Celeron® processors (Kaby Lake-U)
- 2 DDR4-2133 SO-DIMM for up to 32GB of memory
- Max. up to 6 lanes of PCI Express
- 3 SATA-600
- 4 USB 3.0 and 8 USB 2.0
- TPM 1.2 supported
- AXView 2.0 intelligent remote management software

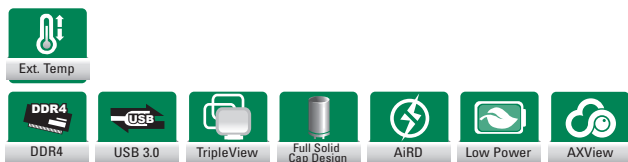

## Core System

CPU	Intel® Core™ i7-7600U/i5-7300U/i3-7100U processor (Kaby Lake-U) & Intel® Celeron® processor 3965U
System Memory	2 x 260-pin DDR4-2133 SO-DIMM, up to 32GB
Chipset	SoC integrated
BIOS	AMI uEFI (Legacy free)
SSD	N/A
Watchdog Timer	65536 levels, 0 to 65535 sec.
Expansion Interface	6 x PCI Express Gen3
Battery Lithium	N/A
Power Input	ATX: +12V, +5VSB AT: +12V
Dimensions	95 x 95 mm
Board Thickness	2.0 mm
Operating Temperature	-40°C to +85°C (-40°F to +185°F)
Humidity	10% to 95% relative humidity, non-condensing
Vibration Endurance	3.5 Grms

## I/O

SATA	3 x SATA-600
Hardware Monitoring	Yes
Ethernet	1 x 10/100/1000 Mbps Ethernet with Intel® i219-LM; supports Wake-on-LAN, PXE Boot ROM
Audio	HD link interface to baseboard for Codec
USB	4 x USB 3.0 8 x USB 2.0
Serial	1 x LPC 1 x SPI 2 x TX/RX
TPM	TPM 1.2
SMBus	Yes
Others	1 x I <sup>2</sup> C
GPIO	4-CH in & 4-CH out (SDIO optional)
Smart Battery	Yes

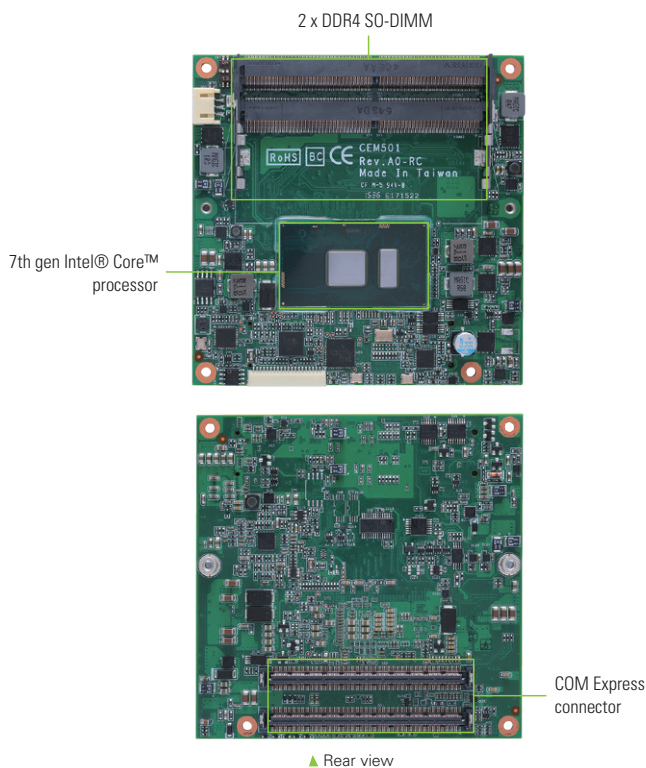

## Display

Chipset	Intel® gen 9 Graphics Engine Supports Gfx - DX12.0, OCL2.0, OGL4.3
Display Interface	2 x DDI (DP/HDMI/DVI); the 2nd DDI could be configured to VGA (optional) 1 x LVDS; 18/24-bit dual channel (eDP optional)

## Packing List

Quick installation guide

## Ordering Information

Standard	
CEM511PG-i7-7600U (P/N: E38D511102)	COM Express Type 6 Compact module with Intel® Core™ i7-7600U, DDI, LVDS, GbE LAN, USB 3.0 and TPM
CEM511PG-i5-7300U (P/N: E38D511101)	COM Express Type 6 Compact module with Intel® Core™ i5-7300U, DDI, LVDS, GbE LAN, USB 3.0 and TPM
CEM511PG-i3-7100U (P/N: E38D511100)	COM Express Type 6 Compact module with Intel® Core™ i3-7100U, DDI, LVDS, GbE LAN, USB 3.0 and TPM
CEM511PG-Cel-3965U (P/N: E38D511103)	COM Express Type 6 Compact module with Intel® Celeron® 3965U, DDI, LVDS, GbE LAN, USB 3.0 and TPM
Optional	
CEB94011 (P/N: E394011100)	COM Express Type 6 application board
7108D511000E	CEM511 heat sink with fan
5078D501200E	CEM501 heat spreader

# CEM700 NEW

COM Express Type 7 Basic Module with Intel® Xeon® D-1500 & Pentium® Processor D1500

## Features

- Intel® Xeon® D-1500 and Pentium® Processor D1500 (Broadwell-DE)
- 2 DDR4-2400 SO-DIMM for up to 32GB of memory
- 1 PCIe x16 Gen3, 1 PCIe x8 Gen3, 8 PCIe x1 Gen2
- 2 SATA-600
- 4 USB 3.0 and 4 USB 2.0
- Two 10GBASE-KR
- TPM 2.0 supported



### Core System

CPU	Intel® Xeon® D-1577 1.3/2.1GHz 24MB, 45W (16C) Intel® Xeon® D-1539 1.6/2.2GHz 12MB, 35W (8C) Intel® Xeon® D-1548 2.0/2.6GHz 12MB, 45W (8C) Intel® Xeon® D-1527 2.2/2.7GHz 6MB, 35W (4C) Intel® Pentium® D1519 1.5/2.1GHz 6MB, 25W (4C) Intel® Pentium® D1508 2.2/2.6GHz 3MB, 25W (2C)
System Memory	2 x 260-pin DDR4-2400 ECC SO-DIMM, up to 32GB
Chipset	SoC integrated
BIOS	AMI uEFI (Legacy free)
SSD	N/A
Watchdog Timer	65536 levels, 0 to 65535 sec.
Expansion Interface	1 x PCIe x16 Gen3 1 x PCIe x8 Gen3 8 x PCIe x1 Gen2
Battery Lithium	N/A
Power Input	ATX: +12V, +5VSB AT: +12V
Dimensions	125 x 95 mm
Board Thickness	2.0 mm
Operating Temperature	Industrial: -40°C ~ 85°C (-40°F ~ 185°F) Standard: 0°C ~ 60°C (32°F ~ 140°F)
Humidity	10% to 95% relative humidity, non-condensing
Vibration Endurance	3.5 Grms

### I/O

SATA	2 x SATA-600
Hardware Monitoring	Yes
Ethernet	1 x 10/100/1000 Mbps Ethernet with Intel® i210 2 x 10GBASE-KR with Intel® 10G Ethernet controller
Audio	N/A
USB	4 x USB 3.0 4 x USB 2.0
Serial	2 x TX/RX
TPM	TPM 2.0
SMBus	Yes
Others	1 x I <sup>2</sup> C 1 x LPC 1 x SPI
GPIO	4-CH in & 4-CH out
Smart Battery	N/A

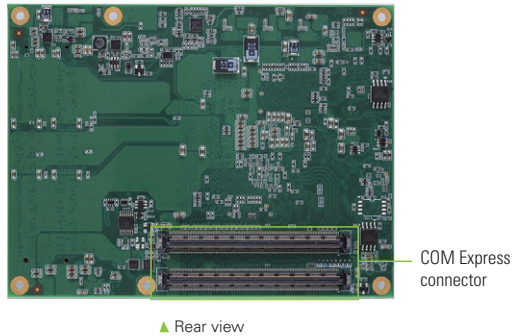
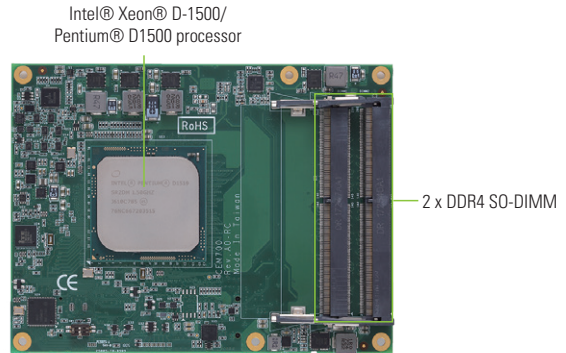

### Packing List

Quick installation guide

### Ordering Information

Standard	
CEM700-D1577 (P/N: TBD)	COM Express Type 7 Basic module with Intel® Xeon® D-1577, 10GBASE-KR, USB 3.0 and TPM
CEM700-D1539 (P/N: TBD)	COM Express Type 7 Basic module with Intel® Xeon® D-1539, 10GBASE-KR, USB 3.0 and TPM
CEM700-D1548 (P/N: TBD)	COM Express Type 7 Basic module with Intel® Xeon® D-1548, 10GBASE-KR, USB 3.0 and TPM
CEM700-D1527 (P/N: TBD)	COM Express Type 7 Basic module with Intel® Xeon® D-1527, 10GBASE-KR, USB 3.0 and TPM
CEM700-D1519 (P/N: TBD)	COM Express Type 7 Basic module with Intel® Pentium® D-1519, 10GBASE-KR, USB 3.0 and TPM
CEM700-D1508 (P/N: TBD)	COM Express Type 7 Basic module with Intel® Pentium® D-1508, 10GBASE-KR, USB 3.0 and TPM
Optional	
CEB94701 (P/N: E3947011100)	COM Express Type 7 development board
TBD	CEM700 heat sink with fan
TBD	CEM700 heat spreader



# CEB94017 NEW

## COM Express Type 10 Development Baseboard

### Features

- COM Express Type 10 baseboard
- 2 SATA-300 and SD card slot
- 1 PCI Express Mini Card slot
- 5 USB 2.0 and 2 USB 3.0
- Port 80 display for debugging

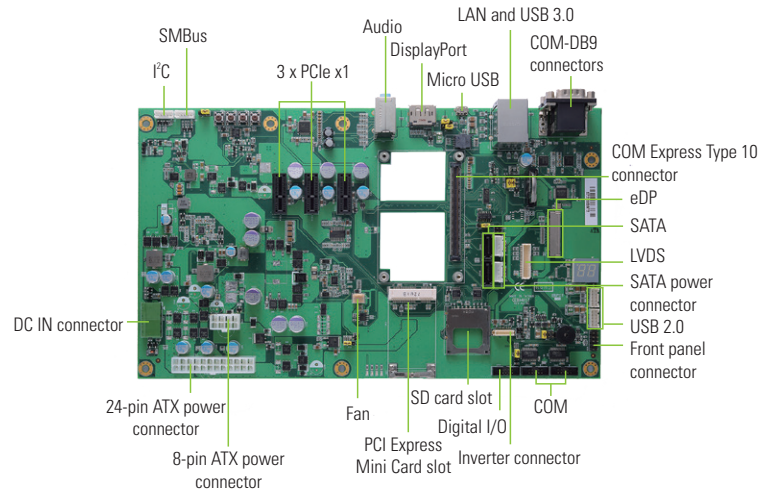

### Core System

CPU	On the module
System Memory	On the module
Chipset	SoC integrated
BIOS	On the module
SD	1 x SD card slot
Watchdog Timer	On the module
Expansion Interface	3 x PCIe x1 1 x Full-size PCI Express Mini Card slot
Battery Lithium	Lithium 3V/195mAH
Power Input	DC input: 5V - 20V (max @ 10A), support single power source and VCC_RTC from COM Express connector AT/ATX mode support
Dimensions	293.4 x 171.5 mm
Operating Temperature	-40°C to +85°C (-40°F to +185°F)
Humidity	10% to 95% relative humidity, non-condensing

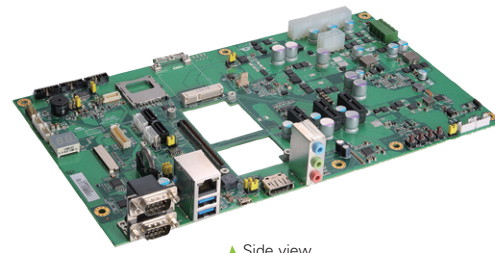

### I/O

SATA	2 x SATA
Hardware Monitoring	N/A
Ethernet	1 x 10/100/1000 Mbps Ethernet
Audio	1 x Audio jack
USB	4 x USB 2.0 (wafer connector) 2 x USB 3.0 1 x micro USB (USB 2.0)
Serial	2 x TX/RX 2 x RS-232/422/485
TPM	N/A
SMBus	Yes
Others	Port 80 Display      Dual 7 segments port 80 display for convenient debugging purpose through LPC interface
GPIO	4-CH in & 4-CH out
Display	1 x 40-pin LVDS / 1 x 8-pin inverter connector 1 x eDP 1 x jumper for LVDS panel 3.3V/5V/12V voltage selection 1 x jumper selection LVDS/eDP 1 x DisplayPort

### Packing List

Quick installation guide, user's manual/utility CD

### Ordering Information

Standard	
CEB94017 (P/N: E394017101)	COM Express Type 10 development baseboard
Compliant Modules	
CEM846 Series	COM Express Type 10 Mini module with Intel® Atom® E3845/3827/ 3815, 4GB/2GB, DDI/LVDS, GbE LAN and USB 3.0
CEM300 Series	COM Express Type 10 Mini module with Intel® Pentium® N3710/Celeron® N3160/N3060, 4GB, DDI/LVDS, GbE LAN and USB 3.0
CEM310 series	COM Express Type 10 Mini module with Intel® Atom® x7-E3950/x5-E3940/x5-E3930, DDI/LVDS, USB 3.0 and GbE LAN
CEM311 series	COM Express Type 10 Mini module with Intel® Pentium® N4200/Celeron® N3350, DDI/LVDS, USB 3.0 and GbE LAN



# CEB94018

COM Express Type 10 Mini Application Board with LVDS, VGA, Dual LANs and Audio

## Features

- 84 x 55 mini size form factor
- 2 GbE LANs
- SATA and mSATA
- LVDS and VGA
- 6 USB 2.0
- 2 PCI Express Mini Card slots

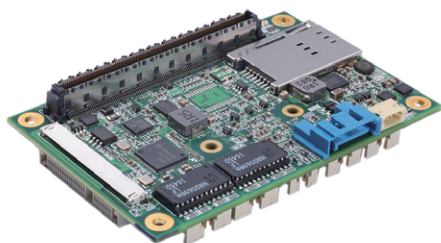

▲ Side view



## Core System

CPU	On the module
System Memory	On the module
Chipset	On the module
BIOS	On the module
SSD	N/A
Watchdog Timer	On the module
Expansion Interface	2 x Half-size PCI Express Mini Card slot 1 x SIM card slot
Battery Lithium	Lithium 3V/220 mAh
Power Input	AT/ATX: +5V DC in, +9V to +14 DC in (option)
Dimensions	84 x 55 mm
Board Thickness	1.6 mm
Operating Temperature	-40°C to +85°C (-40°F to +185°F)
Humidity	10% to 95% relative humidity, non-condensing

## I/O

SATA	1 x SATA-600
Hardware Monitoring	Yes
Ethernet	1 x 10/100/1000 Mbps Ethernet with Intel® i210-IT; supports Wake-on-LAN, PXE Boot ROM 1 port with 10/100/1000 Mbps signals routed from CPU module
Audio	HD audio with Line-out & MIC-in
USB	6 x USB 2.0
Serial	2 x RS-232 TX/RX/RS-422/RS-485
TPM	N/A
SMBus	N/A
Others	1 x I <sup>2</sup> C
GPIO	3-CH in & 3-CH out
Display	1 x LVDS; 18/24-bit single channel 1 x VGA

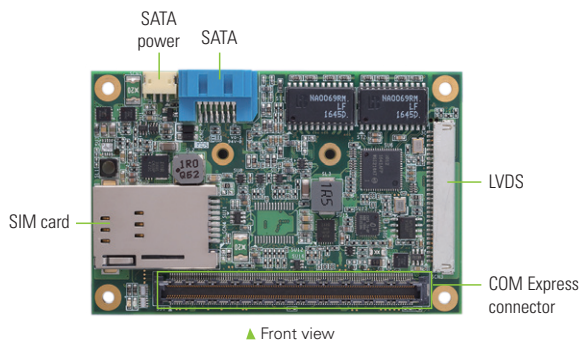

▲ Front view

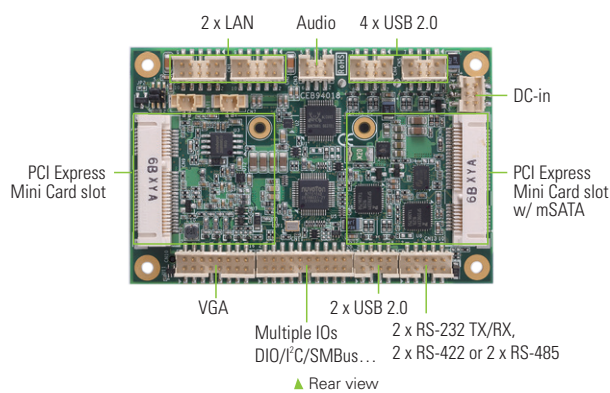

▲ Rear view

## Packing List

Quick installation guide; user's manual/utility CD

## Ordering Information

### Standard

CEB94018VGA (P/N: E394018100)	COM Express Type 10 Mini application board with 2 PCI Express Mini Card slots, 2 GbE LANs, LVDS, VGA and multiple I/O features
----------------------------------	--

### Accessories include in CEB94018VGA

Power cable  
VGA cable  
USB 2.0 cable  
Audio cable  
LAN cable  
COM cable  
SATA power cable  
System cable

### Compliant Modules

CEM846PG-E3845-4G (P/N: E380846105)	COM Express Type 10 Mini module with Intel® Atom® E3845, 4GB, DDI, LVDS, GbE LAN and USB 3.0
CEM846PG-E3827-4G (P/N: E380846104)	COM Express Type 10 Mini module with Intel® Atom® E3827, 4GB, DDI, LVDS, GbE LAN and USB 3.0
CEM846PG-E3815-2G (P/N: E380846103)	COM Express Type 10 Mini module with Intel® Atom® E3815, 2GB, DDI, LVDS, GbE LAN and USB 3.0
CEM300PG-N3710-4G (P/N: E38D300100)	COM Express Type 10 Mini module with Intel® Pentium® N3710, 4GB, DP, LVDS, USB 3.0 and GbE LAN
CEM300PG-N3160-4G (P/N: E38D300102)	COM Express Type 10 Mini module with Intel® Celeron® N3160, 4GB, DP, LVDS, USB 3.0 and GbE LAN
CEM300PG-N3060-4G (P/N: E38D300104)	COM Express Type 10 Mini module with Intel® Celeron® N3060, 4GB, DP, LVDS, USB 3.0 and GbE LAN
CEM311PG-N4200 (P/N: E38D311103)	COM Express Type 10 Mini module with Intel® Pentium® N4200, DDI, LVDS, USB 3.0 and GbE LAN
CEM311PG-N3350 (P/N: E38D311100)	COM Express Type 10 Mini module with Intel® Celeron® N3350, DDI, LVDS, USB 3.0 and GbE LAN

# CEB94021

COM Express Type 6 Application Board with LVDS, VGA, DDI, Dual LANs and Audio

## Features

- 125 x 95 mini size form factor
- 2 GbE LANs
- SATA-600
- LVDS, VGA and DDI
- 4 USB 2.0 and 2 USB 3.0
- 2 PCI Express Mini Card slots
- 3 RS-232/422/485 and 1 RS-232

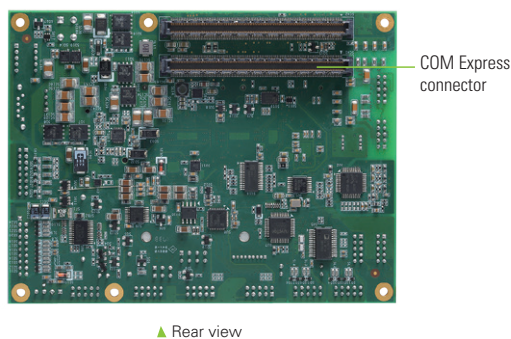
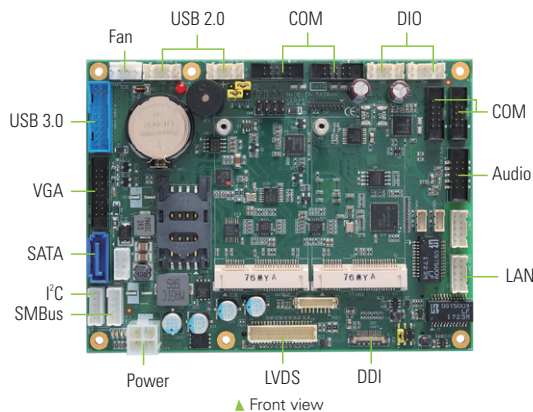

## Core System

CPU	On the module
System Memory	On the module
Chipset	SoC integrated
BIOS	On the module
SSD	N/A
Watchdog Timer	On the module
Expansion Interface	2 x Full-size PCI Express Mini Card slot (one slot support mSATA) 1 x SIM card slot
Battery Lithium	Lithium 3V/220 mAH
Power Input	12V DC input via in a ATX connector
Dimensions	125 x 95 mm
Board Thickness	1.6 mm
Operating Temperature	-40°C to +85°C (-40°F to +185°F)
Humidity	10% to 95% relative humidity, non-condensing

## I/O

SATA	1 x SATA-600
Hardware Monitoring	Yes
Ethernet	1 x 10/100/1000 Mbps Ethernet with Intel® i210-IT; supports Wake-on-LAN, PXE Boot ROM 1 port with 10/100/1000 Mbps signals routed from CPU module
Audio	HD audio with Line-out, MIC-in & Line-in
USB	4 x USB 2.0 2 x USB 3.0
Serial	1 x RS-232 3 x RS-232/422/485
TPM	N/A
SMBus	Yes
others	1 x I²C
GPIO	8-CH in & 8-CH out
Display	1 x LVDS; 18/24-bit single channel 1 x VGA 1 x DDI

## Packing List

Quick installation guide; user's manual/utility CD

## Ordering Information

Standard	
CEB94021VGA (P/N: E394021100)	COM Express Type 6 application board with PCI Express Mini Card slot, 2 GbE LANs, LVDS/VGA and multiple I/O features
Compliant Modules	
CEM500 Series	COM Express Type 6 Basic module with 6th gen Intel® Xeon® and Core™ i7/i5/i3 processor (Skylake-H)
CEM510 Series	COM Express Type 6 Basic module with Intel® Xeon® E3 or 7th gen Intel® Core™ i7/i5/i3 processor (Kaby Lake-H)
CEM501 Series	COM Express Type 6 Compact module with 6th gen Intel® Core™ i7/i5/i3 or Celeron® processor (Skylake-U)
CEM511 Series	COM Express Type 6 Compact module with 7th gen Intel® Core™ i7/i5/i3 or Celeron® 3965U processor (Kaby Lake-U)

# CEB94701 NEW

## COM Express Type 7 Development Baseboard

### Features

- Two 10GBASE-KR SFP+ ports
- 2 SATA-600
- VGA
- 4 USB 3.0
- 2 PCI Express Mini Card slots
- 2 RS-232/422/485

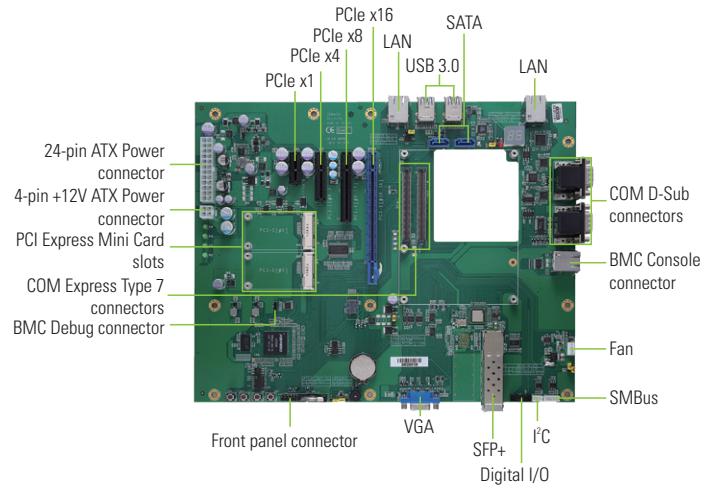

### Core System

CPU	On the module
System Memory	On the module
Chipset	SoC integrated
BIOS	On the module
SSD	N/A
Watchdog Timer	On the module
Expansion Interface	2 x Full-size PCI Express Mini Card slot (one for optional) 1 x PCIe x16 1 x PCIe x8 1 x PCIe x4 1 x PCIe x1
Battery Lithium	Lithium 3V/220 mAh
Power Input	1 x 24-pin ATX connector 1 x 4-pin 12V connector (for module power supply)
Dimensions	244 x 305 mm
Board Thickness	1.6 mm
Operating Temperature	-20°C to +70°C (-4°F to +158°F)
Humidity	10% to 95% relative humidity, non-condensing

### I/O

SATA	2 x SATA-600
Hardware Monitoring	Yes
Ethernet	1 x 10/100/1000 Mbps Ethernet 2 x 10GBASE-KR (SFP+)
Audio	Buzzer
USB	4 x USB 3.0/2.0
Serial	2 x RS-232/422/485 2 x TX/RX
TPM	On module
SMBus	Yes
Others	1 x iC
GPIO	4-CH in & 4-CH out
Display	1 x VGA

### Packing List

Quick installation guide; user's manual/utility CD

### Ordering Information

Standard	
CEB94701 (P/N: E394701100)	COM Express Type 7 development board with two 10GBASE-KR Ethernet ports
Compliant Modules	
CEM700-D1577	COM Express Type 7 basic module with Intel® Xeon® D-1577, 10GBASE-KR, USB 3.0 and TPM
CEM700-D1539	COM Express Type 7 basic module with Intel® Xeon® D-1539, 10GBASE-KR, USB 3.0 and TPM
CEM700-D1548	COM Express Type 7 basic module with Intel® Xeon® D-1548, 10GBASE-KR, USB 3.0 and TPM
CEM700-D1527	COM Express Type 7 basic module with Intel® Xeon® D-1527, 10GBASE-KR, USB 3.0 and TPM
CEM700-D1519	COM Express Type 7 basic module with Intel® Pentium® D-1519, 10GBASE-KR, USB 3.0 and TPM
CEM700-D1508	COM Express Type 7 basic module with Intel® Xeon® D-1508, 10GBASE-KR, USB 3.0 and TPM



# Q7M310

Qseven Module with Intel® Atom® x5 and x7 Processor

## Features

- Intel® Atom® x5 and x7 processors (Apollo Lake)
- Onboard 4GB DDR3L memory (8GB optional)
- 4 lanes of PCI Express slot
- 2 SATA-600
- 2 USB 3.0 and 4 USB 2.0

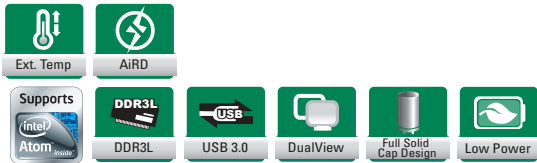

## Core System

CPU	Intel® Atom® x7-E3950 (2.0 GHz) Intel® Atom® x5-E3940 (1.8 GHz) Intel® Atom® x5-E3930 (1.8 GHz)
System Memory	4GB DDR3L memory onboard, up to 8GB (optional)
Chipset	SoC integrated
BIOS	AMI UEFI BIOS (Legacy Free)
SSD	eMMC 32GB (optional)
Watchdog Timer	65536 levels, 0 to 65535 sec.
Expansion Interface	4 x PCIe x1 (3 x PCIe x1 if onboard LAN is supported)
Battery Lithium	N/A
Power Input	ATX: 5V, +5VSB AT: 5V
Dimensions	70 x 70 mm
Board Thickness	1.2 mm
Operating Temperature	Standard: -20°C to +70°C (-4°F to +158°F) Industrial: -40°C to +85°C (-40°F to +185°F)
Humidity	10% to 95% relative humidity, non-condensing

## I/O

SATA	2 x SATA-600
Hardware Monitoring	Yes
Ethernet	1 x 10/100/1000 Mbps Ethernet with Intel® i210-IT; supports Wake-on-LAN, PXE Boot ROM
Audio	HD link interface to baseboard for Codec
USB	2 x USB 3.0 4 x USB 2.0
Serial	1 x LPC (optional with GPIO) 1 x SPI 1 x TX/RX
TPM	N/A
SMBus	Yes
Others	1 x I <sup>2</sup> C 1 x SDIO
GPIO	4-CH in & 4-CH out
Smart Battery	Yes

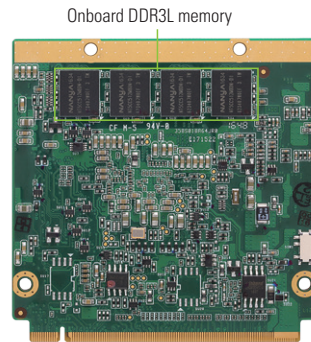
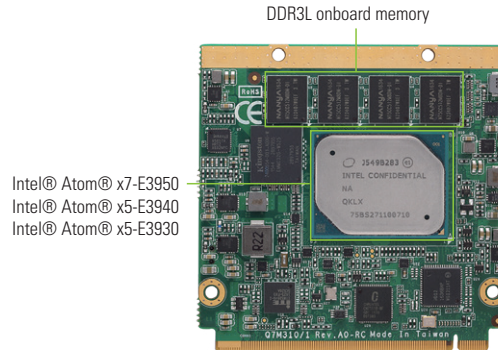

## Display

Chipset	Intel® Gen 9 Graphics Engine Supports Gfx - DX11.1, OCL1.2, OGL 4.2
Display Interface	1 x DDI (DP, HDMI, DVI) 1 x LVDS; 18/24-bit dual channel (eDP optional)

## Packing List

Quick installation guide

## Ordering Information

Standard	
Q7M310-E3940+4GB (Ind.) (P/N : E38Q310101)	Qseven module with Intel® Atom® x5-E3940, 4G DRAM, DDI, LVDS, USB 3.0 and GbE LAN (Industrial temperature)
Q7M310-E3950+4GB (Ind.) (P/N : E38Q310102)	Qseven module with Intel® Atom® x7-E3950, 4G DRAM, DDI, LVDS, USB 3.0 and GbE LAN (Industrial temperature)
Q7M310-E3930+4GB (Ind.) (P/N : E38Q310104)	Qseven module with Intel® Atom® x5-E3940, 4G DRAM, DDI, LVDS, USB 3.0 and GbE LAN (Industrial temperature)
Q7M310-E3930+4GB (P/N : E38Q310105)	Qseven module with Intel® Atom® x5-E3930, 4G DRAM, DDI, LVDS, USB 3.0 and GbE LAN
Q7M310-E3940+4GB (P/N : E38Q310106)	Qseven module with Intel® Atom® x5-E3940, 4G DRAM, DDI, LVDS, USB 3.0 and GbE LAN
Q7M310-E3950+4GB (P/N : E38Q310107)	Qseven module with Intel® Atom® x7-E3950, 4G DRAM, DDI, LVDS, USB 3.0 and GbE LAN



# Q7B301

Qseven Module Rev 2.1 Application Board with LVDS, HDMI, Dual LANs and Audio

## Features

- 100 x 72 mini size form factor
- 2 GbE LANs
- SATA-600
- LVDS and HDMI
- 1 USB 2.0 and 2 USB 3.0
- 2 PCI Express Mini Card slots

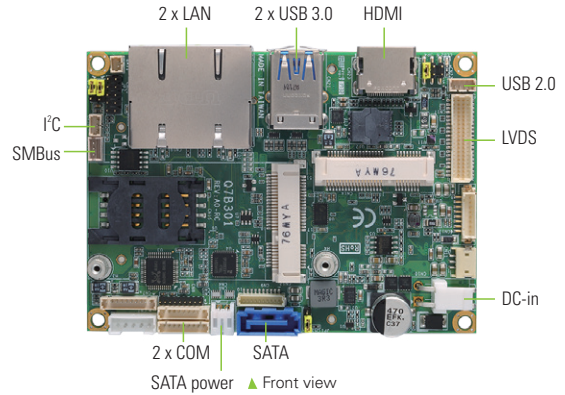

## Core System

CPU	On the module
System Memory	On the module
Chipset	SoC integrated
BIOS	On the module
SSD	N/A
Watchdog Timer	On the module
Expansion Interface	1 x Full-Size PCI Express Mini Card Slot (mSATA supported) 1 x Half-size PCI Express Mini Card slot 1 x SIM card slot
Battery Lithium	N/A
Power Input	2-pin DC-in 12V connector
Dimensions	100 x 72 mm
Board Thickness	1.6 mm
Operating Temperature	-40°C to +85°C (-40°F to +185°F)
Humidity	10% to 95% relative humidity, non-condensing

## I/O

SATA	1 x SATA-600
Hardware Monitoring	Yes
Ethernet	1 x 10/100/1000 Mbps Ethernet with Intel® i210-IT; supports Wake-on-LAN, PXE Boot ROM 1 port with 10/100/1000 Mbps signals routed from CPU module
Audio	HD audio with Line-out & MIC-in
USB	1 x USB 2.0 2 x USB 3.0
Serial	2 x RS-232/422/485
TPM	N/A
SMBus	Yes
Others	1 x I <sup>2</sup> C
GPIO	4-CH in & 4-CH out
Display	1 x LVDS; 18/24-bit single channel 1 x HDMI

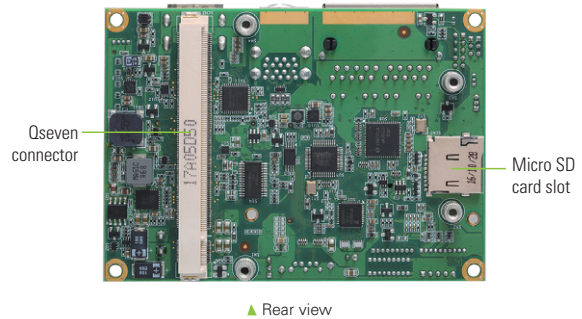

## Packing List

Quick installation guide; user's manual/utility CD

## Ordering Information

<b>Standard</b>	
Q7B301LVDS (P/N: E399301100)	Qseven Rev 2.1 application board with 2 PCI Express Mini Card slots, 2 GbE LANs, LVDS and HDMI





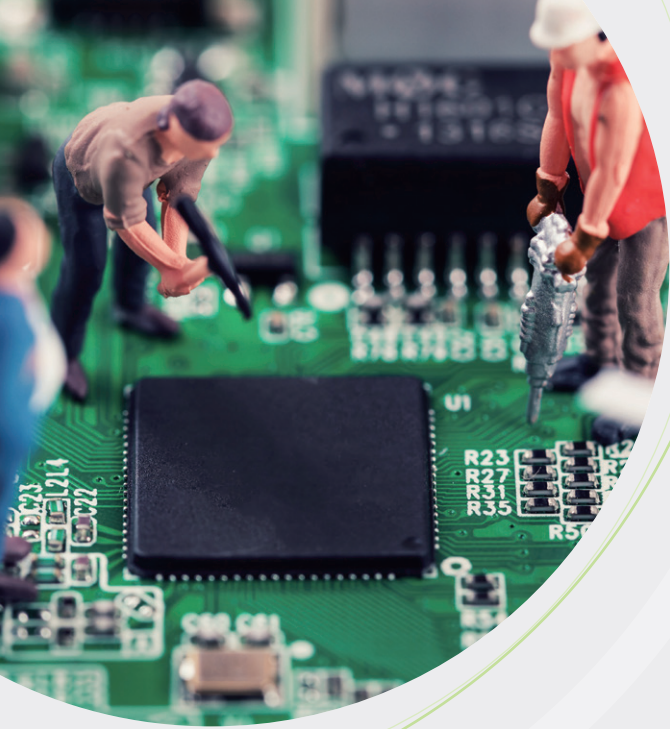

System on Modules

3.5" Embedded Boards

Pico-ITX SBCs

Mini-ITX Motherboards

ATX/Mirco ATX Motherboards

Slot CPU Cards

Smart Display Module



PCI Express Cards

# Boards and Modules

# 2

## 3.5" Embedded Boards

The 3.5" embedded board is created in an architecture of low power consumption with reliability required for various applications in rugged environments. The ZIO form factor is an integrated interface standard defined by Axiomtek and has been adopted as one of our specifications in our 3.5" embedded single board computers to meet concerns regarding insufficient expansion interfaces in small form factor (SFF) single board computers.

	Selection Guide		53
	CAPA84R	3.5" Embedded SBC with Intel® Celeron® Processor J1900/J1800, LVDS, VGA, DisplayPort, 3 GbE LANs and Audio	55
	CAPA500	3.5" Embedded SBC with LGA1151 Socket for 7th/6th Gen Intel® Core™ i7/i5/i3 Processor, LVDS, VGA, HDMI, 2 GbE LANs and Audio	56
	CAPA310	3.5" Embedded SBC with Intel® Atom® x5-E3940 Processor, LVDS, HDMI, 2 GbE LANs and Audio	57
	CAPA313	3.5" Embedded SBC with Intel® Pentium® Processor N4200 & Celeron® Processor N3350, LVDS, HDMI, 2 GbE LANs and Audio	58
	CAPA315	3.5" Embedded SBC with Intel® Pentium® Processor N4200 & Celeron® Processor N3350, eDP, 2 HDMI, 2 GbE LANs and Audio	59

# 3.5" Embedded Boards

## Selection Guide



Features/Models	CAPA84R	CAPA500	CAPA310	
<b>Form Factor</b>	3.5"	3.5"	3.5"	
<b>CPU Level</b>	Intel® Celeron® J1900/J1800	7th/6th gen Intel® Core™ i7/i5/i3 & Celeron®	Intel® Atom® x5-E3940	
<b>CPU Socket</b>	Onboard	LGA1151	Onboard	
<b>Core Logic Chipset</b>	SoC integrated	Intel® H110 Intel® Q170 (optional)	SoC integrated	
<b>Memory Type</b>	DDR3L-1333	DDR4-2400	DDR3L-1867	
<b>Max. DRAM Capacity</b>	8GB	16GB	8GB	
<b>Cache RAM Capacity</b>	Integrated in CPU	Integrated in CPU	Integrated in CPU	
<b>BIOS</b>	AMI UEFI BIOS	AMI UEFI BIOS	AMI UEFI BIOS	
<b>Watchdog Timer</b>	255 Levels, 1 to 255 sec.	255 Levels, 1 to 255 sec.	65536 levels, 1 to 65535 sec.	
<b>SSD</b>	1 x M.2 KEY B	N/A	1 x mSATA	
<b>Digital I/O</b>	8-channel in/out programmable	8-channel in/out programmable	8-channel in/out programmable	
<b>I/O</b>	<b>SATA</b>	1 x SATA-300	1 x SATA-600	
	<b>Serial</b>	<b>COM 1</b>	RS-232/422/485	RS-232/422/485
		<b>COM 2</b>	RS-232	N/A
		<b>COM 3</b>	N/A	N/A
		<b>COM 4</b>	N/A	N/A
<b>USB</b>	2 x USB 2.0 1 x USB 3.0	3 x USB 2.0 3 x USB 3.0	2 x USB 2.0 4 x USB 3.0	
<b>SIM Card Slot</b>	N/A	N/A	N/A	
<b>Display</b>	1 x VGA 1 x DisplayPort 1 x LVDS	1 x VGA 1 x HDMI 1 x LVDS	1 x HDMI 1 x LVDS 1 x VGA (optional)	
<b>Ethernet</b>	3 x 10/100/1000 Mbps Ethernet	2 x 10/100/1000 Mbps Ethernet	2 x 10/100/1000 Mbps Ethernet	
<b>Audio</b>	HD Codec	HD Codec	HD Codec	
<b>Hardware Monitoring</b>	Yes	Yes	Yes	
<b>SMBus</b>	Yes	Yes	Yes	
<b>Expansion Interface</b>	1 x M.2 KEY E	1 x Full-size PCI Express Mini Card slot with mSATA supported 1 x USB, 1 x PCIe x1, 1 x LPC, 1 x SMBus (through a ZIO connector)	1 x Full-size PCI Express Mini Card slot 1 x USB, 1 x PCIe x1, 1 x LPC, 1 x SMBus (through a ZIO connector)	
<b>Power Management</b>	ACPI	ACPI	ACPI	
<b>Battery</b>	Lithium	Lithium	Lithium	
<b>Operating Temperature</b>	-20°C to +70°C (-4°F to +158°F)	-20°C to +60°C (-4°F to +140°F)	-40°C to +80°C (-40°F to +176°F)	
<b>Relative Humidity</b>	10% to 95%, non-condensing	10% to 95%, non-condensing	10% to 95%, non-condensing	
<b>EMI Compliance</b>	CE	CE	CE	

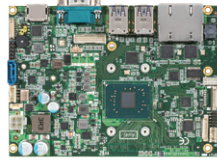

NEW

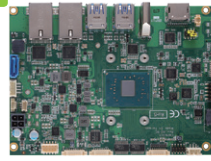

Features/Models	CAPA313	CAPA315		
<b>Form Factor</b>	3.5"	3.5"		
<b>CPU Level</b>	Intel® Pentium® N4200/ Celeron® N3350	Intel® Pentium® N4200/ Celeron® N3350		
<b>CPU Socket</b>	Onboard	Onboard		
<b>Core Logic Chipset</b>	SoC integrated	SoC integrated		
<b>Memory Type</b>	DDR3L-1867	DDR3L-1867		
<b>Max. DRAM Capacity</b>	8GB	8GB		
<b>Cache RAM Capacity</b>	Integrated in CPU	Integrated in CPU		
<b>BIOS</b>	AMI UEFI BIOS	AMI UEFI BIOS		
<b>Watchdog Timer</b>	65536 levels, 1 to 65535 sec.	65536 levels, 1 to 65535 sec.		
<b>SSD</b>	1 x mSATA	1 x mSATA		
<b>Digital I/O</b>	8-channel in/out programmable	8-channel in/out programmable		
<b>I/O</b>	<b>SATA</b>	1 x SATA-600	1 x SATA-600	
	<b>Serial</b>	<b>COM 1</b>	RS-232/422/485	RS-232/422/485
		<b>COM 2</b>	RS-232	RS-232
		<b>COM 3</b>	N/A	RS-232
		<b>COM 4</b>	N/A	RS-232
<b>USB</b>	2 x USB 2.0 4 x USB 3.0	2 x USB 2.0 4 x USB 3.0		
<b>SIM Card Slot</b>	N/A	N/A		
<b>Display</b>	1 x HDMI 1 x LVDS 1 x VGA (optional)	2 x HDMI 1 x eDP		
<b>Ethernet</b>	2 x 10/100/1000 Mbps Ethernet	2 x 10/100/1000 Mbps Ethernet		
<b>Audio</b>	HD Codec	HD Codec		
<b>Hardware Monitoring</b>	Yes	Yes		
<b>SMBus</b>	Yes	Yes		
<b>Expansion Interface</b>	1 x Full-size PCI Express Mini Card slot 1 x USB, 1 x PCIe x1, 1 x LPC, 1 x SMBus (through a ZIO connector)	1 x Full-size PCI Express Mini Card slot		
<b>Power Management</b>	ACPI	ACPI		
<b>Battery</b>	Lithium	Lithium		
<b>Operating Temperature</b>	-20°C to +70°C (-4°F to +158°F)	-20°C to +70°C (-4°F to +158°F)		
<b>Relative Humidity</b>	10% to 95%, non-condensing	10% to 95%, non-condensing		
<b>EMI Compliance</b>	CE	CE		



# CAPA84R NEW

3.5" Embedded SBC with Intel® Celeron® Processor J1900/J1800, LVDS, VGA, DisplayPort, 3 GbE LANs and Audio

## Features

- Intel® Celeron® processor J1900/J1800
- 1 DDR3L SO-DIMM for up to 8GB of memory
- 2 USB 2.0 and 1 USB 3.0
- 3 GbE LANs
- M.2 Key E
- M.2 Key B

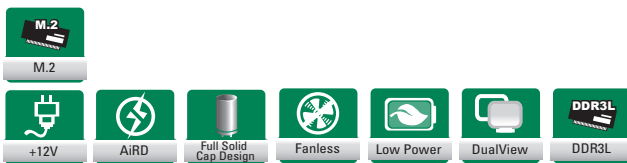

### Core System

CPU	Intel® Celeron® processor J1900/J1800 onboard
System Memory	1 x 204-pin DDR3L-1333 SO-DIMM, up to 8GB
Chipset	SoC integrated
BIOS	AMI
SSD	1 x M.2 Key B (SATA, USB 2.0) in 22 x 42 or 30 x 42
Watchdog Timer	255 levels, 1 to 255 sec.
Expansion Interface	1 x M.2 Key E (PCIe x1) in 22 x 30
Battery Lithium	Lithium 3V/220Mah
Power Input	2 x 2 pin connector +12 VDC-in AT Auto Power On function supported
Power Requirements	Intel® Celeron® J1900 @ 2 GHz 8GB DDR3L Max RMS: +12V @ 1.26A Intel® Celeron® J1800 @ 2.41 GHz 8GB DDR3L Max RMS: +12V @ 1.2A
Dimensions	146 x 104 mm
Board Thickness	1.6 mm
Operating Temperature	-20°C to +70°C (-4°F to 158°F)
Humidity	10% to 95% relative humidity, non-condensing

### I/O

SATA	1 x SATA-300
Hardware Monitoring	Detect CPU/system temperature and voltage
Ethernet	2 x 10/100/1000 Mbps Ethernet with Intel® i211-AT; supports Wake-on-LAN, PXE Boot ROM 1 x 10/100/1000 Mbps Ethernet with Intel® i211-AT; supports Wake-on-LAN, PXE Boot ROM (optional)
Audio	HD Codec audio as MIC-in/Line-in/Line out with Realtek ALC662
USB	2 x USB 2.0 1 x USB 3.0
Serial	1 x RS-232/422/485 1 x RS-232
TPM	N/A
SMBus	Yes
Others	N/A
Digital I/O	8-channel in/out programmed

### Display

Chipset	Intel® integrated Gfx graphic engine
Memory Size	Share system memory
Display Interface	1 x DisplayPort 1 x LVDS; 18/24-bit single/dual channel 1 x VGA

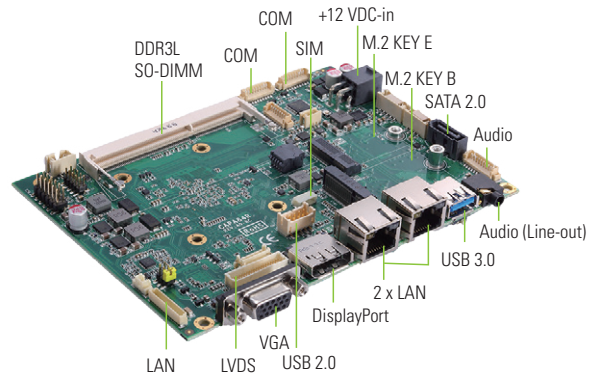

▲ Top view      ▲ Rear view



▲ Assembly View

### Packing List

#### Standard

Quick installation guide, User's Manual/Utility CD

### Ordering Information

#### Standard

CAPA84RPGGA-J1900 (P/N: E38E84R102)	3.5" embedded SBC with Intel® Celeron® processor J1900 (2.0 to 2.5 GHz, 2MB Cache, 10W), LVDS, VGA, DisplayPort, 2 GbE LANs, and audio without heatsink
CAPA84RPGGA-J1900 with heatsink (P/N: E38E84R105)	3.5" embedded SBC with Intel® Celeron® processor J1900 (2.0 to 2.5 GHz, 2MB Cache, 10W), LVDS, VGA, DisplayPort, 2 GbE LANs, audio and heatsink
CAPA84RPGGA-J1800 (P/N: E38E84R103)	3.5" embedded SBC with Intel® Celeron® processor J1800 (2.41 to 2.58 GHz, 1MB Cache, 10W), LVDS, VGA, DisplayPort, 2 GbE LANs, and audio without heatsink
CAPA84RPGGA-J1800 with heatsink (P/N: E38E84R107)	3.5" embedded SBC with Intel® Celeron® processor J1800 (2.41 to 2.58 GHz, 1MB Cache, 10W), LVDS, VGA, DisplayPort, 2 GbE LANs, audio and heatsink

#### Optional

CAPA84RP3GA-J1900 (P/N: E38E84R100)	3.5" embedded SBC with Intel® Celeron® processor J1900 (2.0 to 2.5 GHz, 2MB Cache, 10W), LVDS, VGA, DisplayPort, 3 GbE LANs, and audio without heatsink
CAPA84RP3GA-J1900 with heatsink (P/N: E38E84R104)	3.5" embedded SBC with Intel® Celeron® processor J1900 (2.0 to 2.5 GHz, 2MB Cache, 10W), LVDS, VGA, DisplayPort, 3 GbE LANs, audio and heatsink
CAPA84RP3GA-J1800 (P/N: E38E84R101)	3.5" embedded SBC with Intel® Celeron® processor J1800 (2.41 to 2.58 GHz, 1MB Cache, 10W), LVDS, VGA, DisplayPort, 3 GbE LANs, and audio without heatsink
CAPA84RP3GA-J1800 with heatsink (P/N: E38E84R106)	3.5" embedded SBC with Intel® Celeron® processor J1800 (2.41 to 2.58 GHz, 1MB Cache, 10W), LVDS, VGA, DisplayPort, 3 GbE LANs, audio and heatsink
7118E84R000E	Heatsink
7128E84R000E	Heatspreader
59312260020E	Audio cable with bracket, P=1.25 mm, L=450 mm
59380880250E	COM Port cable DB9-9 x 1-pin, P=1.25, L=250 mm
59382631000E	2 x USB 2.0 cable with bracket, L=180 mm
594P8800600E	SATA power cable



# CAPA500

3.5" Embedded SBC with LGA1151 Socket for 7th/6th Gen Intel® Core™ i7/i5/i3 Processor, LVDS, VGA, HDMI, 2 GbE LANs and Audio

## Features

- LGA1151 7th/6th gen Intel® Core™ i7/i5/i3 processor (Kaby Lake/Skylake)
- Intel® H110 chipset (Q170 optional)
- 1 DDR4 SO-DIMM for up to 16GB of memory
- 3 USB 2.0 and 3 USB 3.0
- Intel® AMT 11 supported (optional)



## Core System

CPU	LGA1151 socket for 7th/6th gen Intel® Core™ i7/i5/i3 processor (TDP=35W only)
System Memory	1 x 260-pin DDR4-2400 SO-DIMM, up to 16GB
Chipset	Intel® H110 Intel® Q170 (optional)
BIOS	AMI
SSD	N/A
Watchdog Timer	255 levels, 1 to 255 sec.
Expansion Interface	1 x Full-size PCI Express Mini Card slot with mSATA supported 1 x USB, 1 x PCIe x1, 1 x LPC, 1 x SMBus through a ZIO connector (optional)
Battery Lithium	Lithium 3V/220mAH
Power Input	2 x 2-pin connector +12V DC-in only AT Auto Power On function supported
Dimensions	146 x 104 mm
Board Thickness	1.6 mm
Operating Temperature	-20°C to +60°C (-4°F to +140°F)
Humidity	10% to 95% relative humidity, non-condensing

## I/O

SATA	1 x SATA-600
Hardware Monitoring	Detect CPU/system temperature, voltage and fan speed
Ethernet	1 x 10/100/1000 Mbps Ethernet with Intel® i211-AT; supports Wake-on-LAN, PXE Boot ROM 1 x 10/100/1000 Mbps Ethernet with Intel® i219-LM; supports Wake-on-LAN, PXE Boot ROM
Audio	HD Codec audio as MIC-in/Line-in/Line-out with Realtek ALC662
USB	3 x USB 3.0 3 x USB 2.0
Serial	1 x RS-232/422/485; with +5V/+12V powered
TPM	N/A
SMBus	Yes
Others	Intel® AMT 11 (optional)
Digital I/O	8-channel in/out programmable

## Display

Chipset	Intel® integrated Gfx graphic engine
Memory Size	Share system memory
Display Interface	1 x VGA 1 x LVDS; 18/24-bit single/dual channel 1 x HDMI

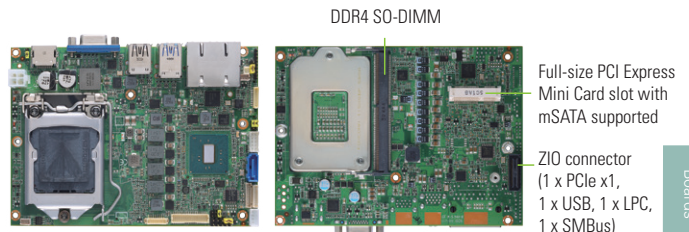
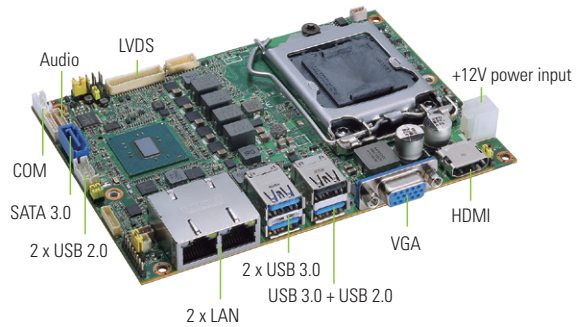

▲ Top view

▲ Rear view



▲ Assembly View

## Packing List

### Standard

Quick installation guide, user's manual/utility CD and accessories

### Accessories

59380880250E	COM port cable DB9-9 x 1-pin, P=1.25, L=250 mm
59382631000E	2 x USB 2.0 cable with bracket, L=180 mm
5078E880100E	Heatsink with fan

## Ordering Information

### Standard

CAPA500VHGGGA-H110 (P/N: E38E500103)	3.5" embedded SBC with LGA1151 socket 7th/6th gen Intel® Core™ i7/i5/i3 processor, Intel® H110 chipset, LVDS, VGA, HDMI, 2 GbE LANs, audio and gift box
CAPA500VHGGGA-Q170 (E38E500102)	3.5" embedded SBC with LGA1151 socket 7th/6th gen Intel® Core™ i7/i5/i3 processor, Intel® Q170 chipset, LVDS, VGA, HDMI, 2 GbE LANs, audio and gift box
CAPA500VHGGGA-H110-ZIO (P/N: E38E500101)	3.5" embedded SBC with LGA1151 socket 7th/6th gen Intel® Core™ i7/i5/i3 processor, Intel® H110 chipset, LVDS, VGA, HDMI, 2 GbE LANs, audio and ZIO connector
CAPA500VHGGGA-Q170-ZIO (P/N: E38E500100)	3.5" embedded SBC with LGA1151 socket 7th/6th gen Intel® Core™ i7/i5/i3 processor, Intel® Q170 chipset, LVDS, VGA, HDMI, 2 GbE LANs, audio and ZIO connector

### Optional

AX93262 (P/N: E393262100)	ZIO module for 2 RS-232/422/485, 2 RS-232, 1 PCI Express Mini Card slot
AX93285 (P/N: E393285100)	ZIO module for 2 RS-232, 32-bit programmable DIO
AX93291 (P/N: E393291100)	ZIO module for 2 RS-232, 2 GbE LAN
AX93295 (P/N: E393295100)	ZIO module for 2 isolated RS-232, 2 USB 3.0

# CAPA310 NEW

3.5" Dual Embedded SBC with Intel® Atom® x5-E3940 Processor, LVDS, HDMI, 2 GbE LANs and Audio

## Features

- Intel® Atom® x5-E3940 processor
- 1 DDR3L SO-DIMM for up to 8GB of memory
- 2 USB 2.0 and 4 USB 3.0
- 1 PCI Express Mini Card slot
- ZIO connector

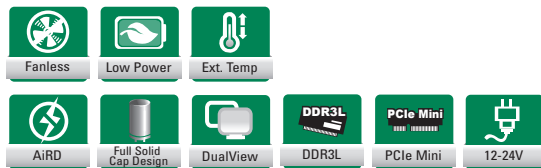

### Core System

CPU	Intel® Atom® x5-E3940 processor onboard
System Memory	1 x 204-pin DDR3L-1867 SO-DIMM, up to 8GB
Chipset	SoC integrated
BIOS	AMI
SSD	1 x mSATA
Watchdog Timer	65536 levels, 1 to 65535 sec.
Expansion Interface	1 x Full-size PCI Express Mini Card slot 1 x USB, 1x PCIe x1, 1x LPC, 1 x SMBus through a ZIO connector
Battery Lithium	Lithium 3V/220mAh
Power Input	2 x 2 pin connector +12V to 24 VDC-in AT Auto Power On function supported
Power Requirements	TBD
Dimensions	146 x 104 mm
Board Thickness	1.6 mm
Operating Temperature	-40°C to +80°C (-40°F to 185°F)
Humidity	10% to 95% relative humidity, non-condensing

### I/O

SATA	1 x SATA-600
Hardware Monitoring	Detect CPU/system temperature and voltage
Ethernet	2 x 10/100/1000 Mbps Ethernet with Intel® i211-AT; support Wake-on-LAN, PXE Boot ROM
Audio	HD Codec audio as MIC-in/Line-in/Line out with Realtek ALC662
USB	2 x USB 2.0 4 x USB 3.0
Serial	1 x RS-232/422/485 1 x RS-232
TPM	ST ST33HTPH2E32AHA6 with TPM 2.0 compliant (optional)
SMBus	Yes
Others	1 x I <sup>2</sup> C
Digital I/O	8-channel in/out programmed

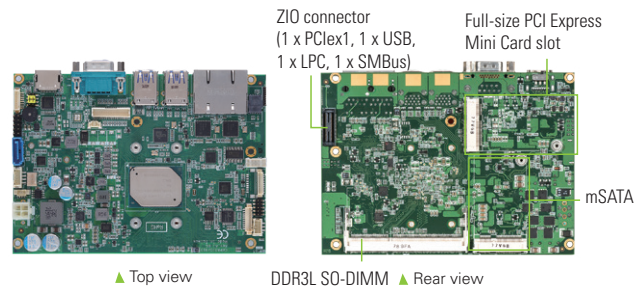
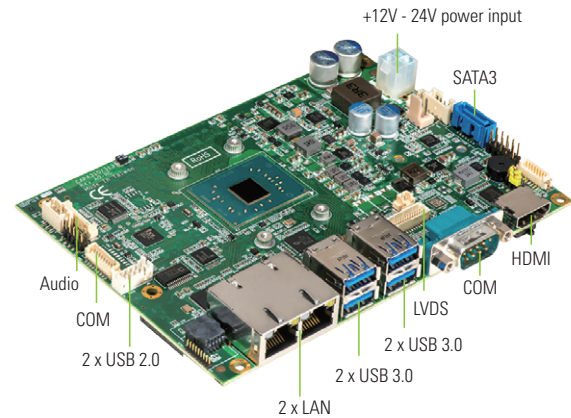

### Display

Chipset	Intel® integrated Gfx graphic engine
Memory Size	Share system memory
Display Interface	1 x HDMI 1 x LVDS; 18/24-bit single/dual channel 1 x VGA (optional)

### Packing List

<b>Standard</b>	Quick installation guide, User's Manual/Utility CD and heatsink
-----------------	---

### Ordering Information

<b>Standard</b>	CAPA310HGGA-E3940-ZIO	3.5" embedded SBC with Intel® Atom® x5-E3940 processor (1.6 to 1.8 GHz, 2MB Cache, 9.5W), HDMI, LVDS, 2 GbE LANs, audio and ZIO
-----------------	-----------------------	---

<b>Optional</b>	AX93262 (P/N: E393262100)	ZIO module for 2 RS-232/422/485, 2 RS-232, 1 PCI Express Mini Card slot
	AX93285 (P/N: E393285100)	ZIO module for 2 RS-232, 32-bit programmable DIO
	AX93291 (P/N: E393291100)	ZIO module for 2 RS-232, 2 GbE LAN
	AX93295 (P/N: E393295100)	ZIO module for 2 isolated RS-232, 2 USB 3.0

# CAPA313

3.5" Embedded SBC with Intel® Pentium® Processor N4200 & Celeron® Processor N3350, LVDS, HDMI, 2 GbE LANs and Audio

## Features

- Intel® Pentium® processor N4200/Celeron® processor N3350
- 1 DDR3L SO-DIMM for up to 8GB of memory
- 2 USB 2.0 and 4 USB 3.0
- 1 PCI Express Mini Card slot
- ZIO connector

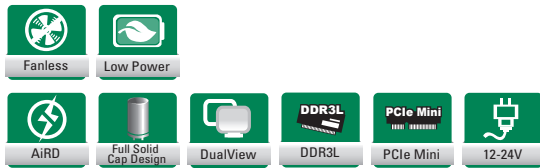

### Core System

CPU	Intel® Pentium® processor N4200/Celeron® processor N3350 onboard
System Memory	1 x 204-pin DDR3L-1867 SO-DIMM, up to 8GB
Chipset	SoC integrated
BIOS	AMI
SSD	1 x mSATA
Watchdog Timer	65536 levels, 1 to 65535 sec.
Expansion Interface	1 x Full-size PCI Express Mini Card slot 1 x USB, 1 x PCIe x1, 1 x LPC, 1 x SMBus through a ZIO connector
Battery Lithium	Lithium 3V/220mAH
Power Input	2 x 2-pin connector +12V to 24V DC-in AT Auto Power On function supported
Power Requirements	Intel® Pentium® N4200 @1.1 GHz 8GB DDR3L Max. RMS: +24V @ 0.8A Intel® Celeron® N3350 @1.1 GHz 8GB DDR3L Max. RMS: +24V @ 0.7A
Dimensions	146 x 104 mm
Board Thickness	1.6 mm
Operating Temperature	-20°C to +70°C (-4°F to +158°F)
Humidity	10% to 95% relative humidity, non-condensing

### I/O

SATA	1 x SATA-600
Hardware Monitoring	Detect CPU/system temperature and voltage
Ethernet	2 x 10/100/1000 Mbps Ethernet with Intel® i211-AT; support Wake-on-LAN, PXE Boot ROM
Audio	HD Codec audio as Mic-in/Line-in/Line-out with Realtek ALC662
USB	2 x USB 2.0 4 x USB 3.0
Serial	1 x RS-232/422/485 1 x RS-232
TPM	ST ST33HPTH2E32AHA6 with TPM 2.0 compliant (optional)
SMBus	Yes
Others	1 x I <sup>2</sup> C
Digital I/O	8-channel in/out programmable

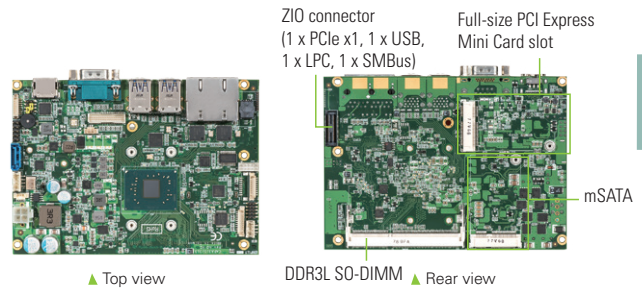
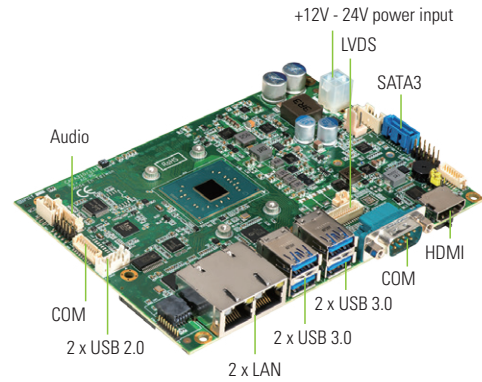

### Display

Chipset	Intel® integrated Gfx graphic engine
Memory Size	Share system memory
Display Interface	1 x HDMI 1 x LVDS; 18/24-bit single/dual channel 1 x VGA (optional)

### Packing List

<b>Standard</b>	Quick installation guide, user's manual/utility CD and heatsink
-----------------	---

### Ordering Information

<b>Standard</b>	
CAPA313HGGA-N4200-ZIO (P/N: E38E313100)	3.5" embedded SBC with Intel® Pentium® processor N4200 (1.1 to 2.5 GHz, 2MB Cache, 6W), HDMI/LVDS, 2 GbE LANs and audio
CAPA313HGGA-N3350-ZIO (P/N: E38E313102)	3.5" embedded SBC with Intel® Celeron® processor N3350 (1.1 to 2.4 GHz, 2MB Cache, 6W), HDMI/LVDS, 2 GbE LANs and audio

<b>Optional</b>	
AX93262 (P/N: E393262100)	ZIO module for 2 RS-232/422/485, 2 RS-232, 1 PCI Express Mini Card slot
AX93285 (P/N: E393285100)	ZIO module for 2 RS-232, 32-bit programmable DIO
AX93291 (P/N: E393291100)	ZIO module for 2 RS-232, 2 GbE LAN
AX93295 (P/N: E393295100)	ZIO module for 2 isolated RS-232, 2 USB 3.0

# CAPA315 NEW

3.5" Embedded SBC with Intel® Pentium® N4200 & Celeron® Processor N3350, eDP, 2 HDMI, 2 GbE LANs and Audio

## Features

- Intel® Pentium® N4200/Celeron® N3350 processor
- 1 DDR3L SO-DIMM for up to 8GB of memory
- 2 USB 2.0 and 4 USB 3.0
- 2 HDMI and 1 eDP
- 1 PCI Express Mini Card slot

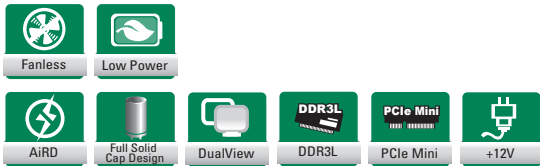
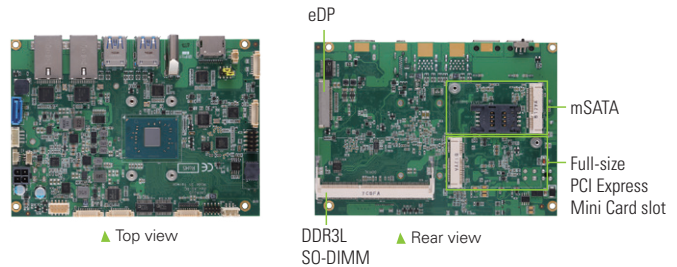
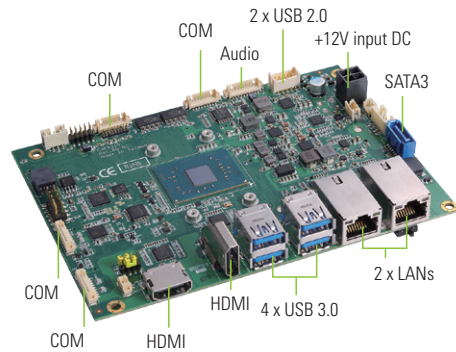

### Core System

CPU	Intel® Pentium® processor N4200/Celeron® processor N3350 onboard
System Memory	1 x 204-pin DDR3L-1867 SO-DIMM, up to 8GB
Chipset	SoC integrated
BIOS	AMI
SSD	1 x mSATA
Watchdog Timer	65536 levels, 1 to 65535 sec.
Expansion Interface	1 x Full-size PCI Express Mini Card slot
Battery Lithium	Lithium 3V/220mAH
Power Input	2 x 2-pin DC in power connector +12V DC-in only AT Auto Power On function supported
Power Requirements	Intel® Pentium® N4200 @ 1.1 GHz, 8GB DDR3L Max. RMS: +12V @ 1.5A Intel® Celeron® N3350 @ 1.1 GHz, 8GB DDR3L Max. RMS: +12V @ 1.2A
Dimensions	146 x 104 mm
Board Thickness	1.6 mm
Operating Temperature	-20 to +70°C (-4°F to +158°F)
Humidity	10% to 95% relative humidity, non-condensing

### I/O

SATA	1 x SATA-600
Hardware Monitoring	Detect CPU/system temperature, and voltage
Ethernet	2 x 10/100/1000 Mbps Ethernet with Intel® i211-AT; support Wake-on-LAN, PXE Boot ROM
Audio	HD Codec audio as MIC-in/Line-in/Line out with Realtek ALC662
USB	2 x USB 2.0 4 x USB 3.0
Serial	1 x RS-232/422/485 3 x RS-232
TPM	ST ST33HTPH2E32AHB3 with TPM 1.2 compliant (optional)
SMBus	Yes
Others	1 x I <sup>2</sup> C
Digital I/O	8-channel in/out programmed

### Display

Chipset	Intel® integrated Gfx graphic engine
Memory Size	Share system memory
Display Interface	2 x HDMI 1 x eDP

### Packing List

<b>Standard</b>	Quick installation guide, User's Manual/Utility CD and heatsink
-----------------	---



### Ordering Information

<b>Standard</b>	
CAPA315HGGA-N4200 (P/N:E38E315101)	3.5" embedded SBC with Intel® Pentium® processor N4200 (1.1 to 2.5 GHz, 2MB cache, 6W), dual HDMI, eDP, 2 GbE LANs and audio
CAPA315HGGA-N3350 (P/N:E38E315100)	3.5" embedded SBC with Intel® Celeron® processor N3350 (1.1 to 2.4 GHz, 2MB cache, 6W), dual HDMI, eDP, 2 GbE LANs and audio

# 3

## Pico-ITX SBCs

The Pico-ITX SBC is the world's smallest x86 embedded board, measured at the size of 100 mm x 72 mm only. The Pico-ITX SBC provides system developers and OEMs with an ultra compact yet highly integrated platforms that deliver excellent computing performance at remarkably low power consumption. For car PCs, in-flight entertainment systems, industrial automation systems and even portable devices, the Pico-ITX SBC meets customer's demands in compact-size, fanless operation, low power consumption and versatile I/O.

Selection Guide		61
 PICO51R	Pico-ITX SBC with 7th Generation Intel® Core™ i7/i5/i3 and Celeron® processor, DisplayPort, LVDS and 2 GbE LANs	62
PICO316	Pico-ITX SBC with Intel® Pentium® Processor N4200 & Celeron® Processor N3350, HDMI, LVDS, GbE LAN and Audio	63
 PICO318	Pico-ITX SBC with Intel® Pentium® Processor N4200 & Celeron® Processor N3350, DisplayPort, LVDS, 2 GbE LANs and Audio	64
 PICO319	Pico-ITX SBC with Intel® Atom® x5-E3940 Processor, DisplayPort, LVDS, 2 GbE LANs and Audio	65

## Boards and Modules



# Pico-ITX SBCs

## Selection Guide

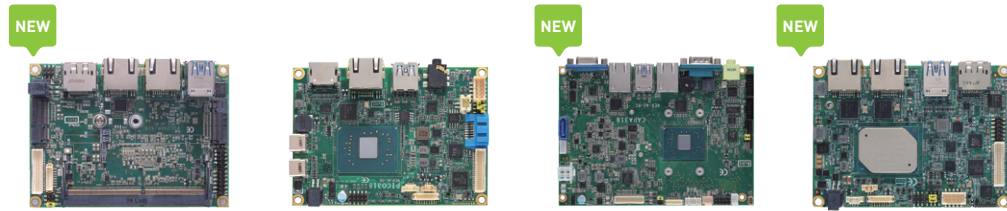

Features/Models	PICO51R	PICO316	PICO318	PICO319	
<b>Form Factor</b>	Pico-ITX	Pico-ITX	Pico-ITX	Pico-ITX	
<b>CPU Level</b>	7th gen Intel® Core™ i7/i5/i3 & Celeron®	Intel® Pentium® N4200/ Celeron® N3350	Intel® Pentium® N4200/ Celeron® N3350	Intel® Atom® x5-E3940	
<b>CPU Socket</b>	Onboard	Onboard	Onboard	Onboard	
<b>Core Logic Chipset</b>	SoC integrated	SoC integrated	SoC integrated	SoC integrated	
<b>Memory Type</b>	DDR4-2133	DDR3L-1867	DDR3L-1867	DDR3L-1867	
<b>Max. DRAM Capacity</b>	16GB	8GB	8GB	8GB	
<b>Cache RAM Capacity</b>	Integrated in CPU	Integrated in CPU	Integrated in CPU	Integrated in CPU	
<b>BIOS</b>	AMI UEFI BIOS	AMI UEFI BIOS	AMI UEFI BIOS	AMI UEFI BIOS	
<b>Watchdog Timer</b>	65536 levels, 1 to 65535 sec.	65536 levels, 1 to 65535 sec.	65536 levels, 1 to 65535 sec.	65536 levels, 1 to 65535 sec.	
<b>SSD</b>	1 x M.2 Key B	N/A	1 x M.2 Key B	1 x M.2 Key B	
<b>Digital I/O</b>	4-channel in/out programmable	N/A	4-channel in/out programmable	4-channel in/out programmable	
<b>I/O</b>	<b>SATA</b>	N/A	1 x SATA-600	N/A	
	<b>Serial</b>	<b>COM 1</b>	RS-232	RS-232/422/485	RS-232/422/485
		<b>COM 2</b>	RS-232/422/485	RS-232	RS-232
	<b>USB</b>	2 x USB 3.0 2 x USB 2.0	3 x USB 3.0 2 x USB 2.0	2 x USB 3.0 2 x USB 2.0	2 x USB 3.0 2 x USB 2.0
<b>SIM Card Slot</b>	N/A	N/A	N/A	N/A	
<b>Display</b>	1 x DisplayPort 1 x LVDS	1 x HDMI 1 x LVDS	1 x DisplayPort 1 x LVDS	1 x DisplayPort 1 x LVDS	
<b>Ethernet</b>	2 x 10/100/1000 Mbps Ethernet	1 x 10/100/1000 Mbps Ethernet	2 x 10/100/1000 Mbps Ethernet	2 x 10/100/1000 Mbps Ethernet	
<b>Audio</b>	N/A	HD Codec	HD Codec	HD Codec	
<b>Hardware Monitoring</b>	Yes	Yes	Yes	Yes	
<b>SMBus</b>	Yes	Yes	Yes	Yes	
<b>Expansion Interface</b>	1 x M.2 KEY E	1 x Full-size PCI Express Mini Card slot with mSATA supported	1 x Half-size PCI Express Mini Card slot with mSATA supported	1 x Half-size PCI Express Mini Card slot with mSATA supported	
<b>Power Management</b>	ACPI	ACPI	ACPI	ACPI	
<b>Battery</b>	Lithium	Lithium	Lithium	Lithium	
<b>Operating Temperature</b>	-20°C to +60°C (-4°F to +140°F)	-20°C to +60°C (-4°F to +140°F) -20°C to +70°C (-4°F to +158°F) (optional)	-20°C to +60°C (-4°F to +140°F)	-40°C to +70°C (-40°F to +158°F)	
<b>Relative Humidity</b>	10% to 95%, non-condensing	10% to 95%, non-condensing	10% to 95%, non-condensing	10% to 95%, non-condensing	
<b>EMI Compliance</b>	CE	CE	CE	CE	

# PICO51R NEW

Pico-ITX SBC with 7th Generation Intel® Core™ i7/i5/i3 and Celeron® Processor, DisplayPort, LVDS and 2 GbE LANs

## Features

- 7th generation Intel® Core™ i7/i5/i3 and Celeron® processor
- 1 DDR4 SO-DIMM for up to 16GB of memory
- 2 USB 2.0 and 2 USB 3.0
- M.2 Key E
- M.2 Key B
- Intel® AMT 11 supported



▲ Assembly view

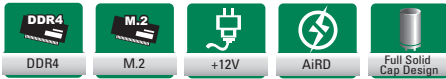

### Core System

CPU	7th gen Intel® i7/i5/i3 and Celeron® processor onboard
System Memory	1 x 260-pin DDR4-2133 SO-DIMM, up to 16GB
Chipset	SoC integrated
BIOS	AMI
SSD	1 x M.2 Key B (SATA, USB 2.0) in 22 x 42
Watchdog Timer	65535 levels, 1 to 65536 sec.
Expansion Interface	1 x M.2 Key E (PCIe x1, USB 2.0) in 22 x 30
Battery Lithium	Lithium 3V/220mAh
Power Input	2 x 2-pin connector +12 VDC-in only AT Auto Power On function supported
Power Requirements	TBD
Dimensions	100 x 72 mm
Board Thickness	1.6 mm
Operating Temperature	-20°C to +60°C (-4°F to 140°F)
Humidity	10% to 95% relative humidity, non-condensing

### I/O

SATA	N/A
Hardware Monitoring	Detect CPU/system temperature, voltage and fan speed
Ethernet	1 x 10/100/1000 Mbps Ethernet with Intel® i219-LM; supports Wake-on-LAN, PXE Boot ROM 1 x 10/100/1000 Mbps Ethernet with Intel® i211-AT; supports Wake-on-LAN, PXE Boot ROM
Audio	N/A
USB	2 x USB 2.0 2 x USB 3.0
Serial	2 x RS-232/422/485
TPM	N/A
SMBus	N/A
Others	1 x I <sup>2</sup> C
Digital I/O	4-channel in/out programmable

### Display

Chipset	Intel® HD Graphics
Memory Size	Share system memory
Display Interface	1 x LVDS; 18/24-bit single/dual channel 1 x DisplayPort

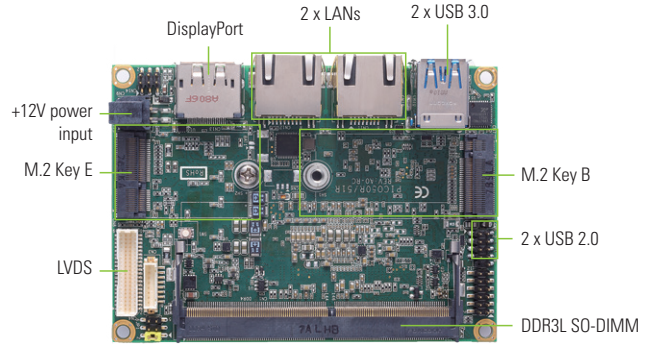

▲ Side view

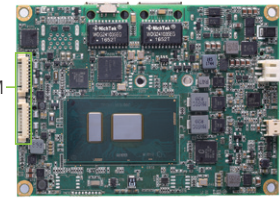

▲ Rear view

### Packing List

<b>Standard</b>	Quick installation guide, User's Manual/Utility CD and accessories
<b>Accessories</b>	594H3160400E Power cable, L=100 mm

### Ordering Information

<b>Standard</b>	
PICO51RPGG-i7-7600U	Pico-ITX SBC with Intel® Core™ processor i7-7600U (2.8 to 3.9 GHz, 4MB Cache, 15W), DisplayPort, LVDS, 2 GbE LANs, 2 USB 2.0, and 2 USB 3.0 without fan
PICO51RPGG-i5-7300U	Pico-ITX SBC with Intel® Core™ processor i5-7300U (2.6 to 3.5 GHz, 3MB Cache, 15W), DisplayPort, LVDS, 2 GbE LANs, 2 USB 2.0, and 2 USB 3.0 without fan
PICO51RPGG-i3-7100U	Pico-ITX SBC with Intel® Core™ processor i3-7100U (2.4 GHz, 3MB Cache, 15W), DisplayPort, LVDS, 2 GbE LANs, 2 USB 2.0, and 2 USB 3.0 without fan
PICO51RPGG-Celeron 3965U	Pico-ITX SBC with Intel® Celeron® processor 3965U (2.2 GHz, 2MB Cache, 15W), DisplayPort, LVDS, 2 GbE LANs, 2 USB 2.0, and 2 USB 3.0 without fan
<b>Optional</b>	
PICO51RPGG-i7-7600U w/fan	Pico-ITX SBC with Intel® Core™ processor i7-7600U (2.8 to 3.9 GHz, 4MB Cache, 15W), DisplayPort, LVDS, 2 GbE LANs, 2 USB 2.0, 2 USB 3.0 and heatsink with fan
PICO51RPGG-i5-7300U w/fan	Pico-ITX SBC with Intel® Core™ processor i5-7300U (2.6 to 3.5 GHz, 3MB Cache, 15W), DisplayPort, LVDS, 2 GbE LANs, 2 USB 2.0, 2 USB 3.0 and heatsink with fan
PICO51RPGG-i3-7100U w/fan	Pico-ITX SBC with Intel® Core™ processor i3-7100U (2.4 GHz, 3MB Cache, 15W), DisplayPort, LVDS, 2 GbE LANs, 2 USB 2.0, 2 USB 3.0 and heatsink with fan
PICO51RPGG-Celeron®-3965U w/fan	Pico-ITX SBC with Intel® Celeron® processor 3965U (2.2 GHz, 2MB Cache, 15W), DisplayPort, LVDS, 2 GbE LAN, 2 USB 2.0, 2 USB 3.0 and heatsink with fan
	Heatspreader
594H3160410E	Power cable for adapter, L=100 mm
50966124030E	Adapter 12V 60W FSP060-DIBAN2 with screw.
59380880250E	COM port cable DB9-9 x 1-pin, P=1.25 mm, L=250 mm
	2 x USB 2.0 cable with bracket, L=180 mm

# PICO316

Pico-ITX SBC with Intel® Pentium® Processor N4200 & Celeron® Processor N3350, LVDS, HDMI, GbE LAN and Audio

## Features

- Intel® Pentium® processor N4200 & Celeron® processor N3350
- 1 DDR3L SO-DIMM for up to 8GB of memory
- 2 USB 2.0 and 3 USB 3.0
- 1 PCI Express Mini Card slot with mSATA supported



## Core System

CPU	Intel® Pentium® processor N4200 & Celeron® processor N3350 onboard
System Memory	1 x 204-pin DDR3L-1867 SO-DIMM, up to 8GB
Chipset	SoC integrated
BIOS	AMI
SSD	N/A
Watchdog Timer	65536 levels, 1 to 65535 sec.
Expansion Interface	1 x Full-size PCI Express Mini Card slot with mSATA supported
Battery Lithium	Lithium 3V/220mAH
Power Input	2 x 2-pin connector +5V DC-in only AT Auto Power On function supported
Power Requirements	Intel® Pentium® N4200 @ 1.1 GHz 8GB DDR3L Max RMS: +5V @ 3.3A Intel® Celeron® N3350 @ 1.1 GHz 8GB DDR3L Max RMS: +5V @ 2.3A
Dimensions	100 x 72 mm
Board Thickness	1.6 mm
Operating Temperature	Standard: -20°C to +60°C (-4°F to +140°F) Optional: -20°C to +70°C (-4°F to +158°F)
Humidity	10% to 95% relative humidity, non-condensing

## I/O

SATA	1 x SATA-600
Hardware Monitoring	Detect CPU/system temperature and voltage
Ethernet	1 x 10/100/1000 Mbps Ethernet with Intel® i211-AT; supports Wake-on-LAN, PXE Boot ROM
Audio	HD Codec audio as Line-out with Realtek ALC662
USB	2 x USB 2.0 3 x USB 3.0
Serial	2 x RS-232
TPM	N/A
SMBus	N/A
Others	1 x I <sup>2</sup> C
Digital I/O	N/A

## Display

Chipset	Intel® integrated Gfx graphic engine
Memory Size	Share system memory
Display Interface	1 x LVDS; 18/24-bit single/dual channel 1 x HDMI

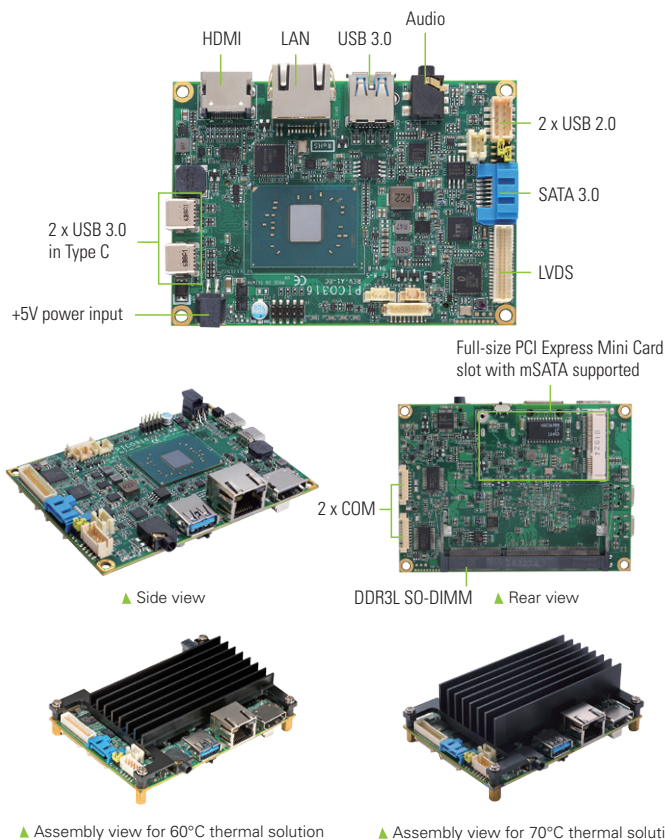

▲ Assembly view for 60°C thermal solution    ▲ Assembly view for 70°C thermal solution

## Packing List

### Standard

Quick installation guide, user's manual/utility CD and accessories

### Accessories

Part Number	Description
594H3160400E	Power Cable L=100 mm

## Ordering Information

### Standard

PICO316HGA-N4200 (P/N: E38H316101)	Pico-ITX SBC with Intel® Pentium® processor N4200 (1.1 to 2.5 GHz, 2MB Cache, 6W), LVDS, HDMI, GbE LAN, 3 USB 3.0 and 2 USB 2.0 without heatsink
PICO316HGA-N3350 (P/N: E38H316100)	Pico-ITX SBC with Intel® Celeron® processor N3350 (1.1 to 2.4 GHz, 2MB Cache, 6W), LVDS, HDMI, GbE LAN, 3 USB 3.0 and 2 USB 2.0 without heatsink

### Optional

PICO316HGA-N3350 60°C (P/N: E38H316102)	Pico-ITX SBC with Intel® Celeron® processor N3350 (1.1 to 2.4 GHz, 2MB Cache, 6W), LVDS, HDMI, GbE LAN, 3 USB 3.0, 2 USB 2.0 and low profile heatsink
PICO316HGA-N4200 60°C (P/N: E38H316103)	Pico-ITX SBC with Intel® Pentium® processor N4200 (1.1 to 2.5 GHz, 2MB Cache, 6W), LVDS, HDMI, GbE LAN, 3 USB 3.0, 2 USB 2.0 and low profile heatsink
PICO316HGA-N3350 70°C (P/N: E38H316104)	Pico-ITX SBC with Intel® Celeron® processor N3350 (1.1 to 2.4 GHz, 2MB Cache, 6W), LVDS, HDMI, GbE LAN, 3 USB 3.0, 2 USB 2.0 and high profile heatsink
PICO316HGA-N4200 70°C (P/N: E38H316105)	Pico-ITX SBC with Intel® Pentium® processor N4200 (1.1 to 2.5 GHz, 2MB Cache, 6W), LVDS, HDMI, GbE LAN, 3 USB 3.0, 2 USB 2.0 and high profile heatsink
5090BE26000E	5V/8A 40W adapter, 4-pin plug with lock
594H3160410E	Power cable for adapter, L=100 mm
7128H316000E	Heatspreader
59380880250E	COM port cable, DB9-9 x 1P, L=250 mm, P=1.25

# PICO318 NEW

Pico-ITX SBC with Intel® Pentium® Processor N4200 & Celeron® Processor N3350, DisplayPort, LVDS, 2 GbE LANs and Audio

## Features

- Intel® Pentium® processor N4200 & Celeron® processor N3350
- 1 DDR3L SO-DIMM for up to 8GB of memory
- 2 USB 2.0 and 2 USB 3.0
- 1 PCI Express Mini Card slot with mSATA supported
- M.2 Key B



### Core System

CPU	Intel® Pentium® processor N4200 & Celeron® processor N3350 onboard
System Memory	1 x 204-pin DDR3L-1867 SO-DIMM, up to 8GB
Chipset	SoC integrated
BIOS	AMI
SSD	1 x M.2 Key B (SATA, USB 2.0, PCIe x2 optional) in 22 x 42 or 30 x 42
Watchdog Timer	65536 levels, 1 to 65535 sec.
Expansion Interface	1 x Half-size PCI Express Mini Card slot with mSATA supported
Battery Lithium	Lithium 3V/220mAh
Power Input	1 x 4-pin connector +12V DC-in only AT Auto Power On function supported
Power Requirements	Intel® Pentium® N4200 @ 1.1 GHz 8GB DDR3L Max RMS: +12V @1.3A Intel® Celeron® N3350 @ 1.1 GHz 8GB DDR3L Max RMS: +12V @1.1A
Dimensions	100 x 72 mm
Board Thickness	1.6 mm
Operating Temperature	-20°C to +60°C (-4°F to +140°F)
Humidity	10% to 95% relative humidity, non-condensing

### I/O

SATA	N/A
Hardware Monitoring	Detect CPU/system temperature and voltage
Ethernet	2 x 10/100/1000 Mbps Ethernet with Intel® i211-AT; support Wake-on-LAN, PXE Boot ROM
Audio	HD Codec audio as Mic-in/Line-in/Line-out with Realtek ALC662
USB	2 x USB 2.0 2 x USB 3.0
Serial	1 x RS-232/422/485 1 x RS-232
TPM	N/A
SMBus	N/A
Others	1 x I <sup>2</sup> C
Digital I/O	4-channel in/out programmable

### Display

Chipset	Intel® integrated Gfx graphic engine
Memory Size	Share system memory
Display Interface	1 x LVDS; 18/24-bit single/dual channel 1 x DisplayPort

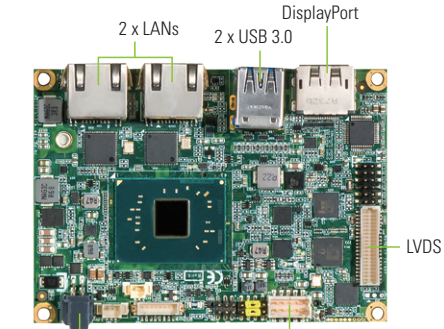

+12V power input 2 x USB 2.0  
Half-size PCI Express Mini Card slot with mSATA supported M.2 Key B



▲ Side view

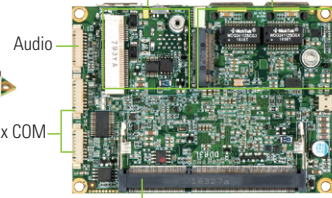

▲ Rear view



▲ Assembly view

### Packing List

<b>Standard</b>	Quick installation guide, user's manual/utility CD and accessories
<b>Accessories</b>	594H3160400E Power cable, L=100 mm

### Ordering Information

<b>Standard</b>	
PICO318PGGA-N4200 (P/N: E38H318101)	Pico-ITX SBC with Intel® Pentium® processor N4200 (1.1 to 2.5 GHz, 2MB cache, 6W), DisplayPort, LVDS, 2 GbE LANs, 2 USB 2.0, and 2 USB 3.0 without heatsink
PICO318PGGA-N3350 (P/N: E38H318100)	Pico-ITX SBC with Intel® Celeron® processor N3350 (1.1 to 2.4 GHz, 2MB cache, 6W), DisplayPort, LVDS, 2 GbE LANs, 2 USB 2.0, and 2 USB 3.0 without heatsink
<b>Optional</b>	
PICO318PGGA-N3350 (P/N: E38H318102)	Pico-ITX SBC with Intel® Celeron® processor N3350 (1.1 to 2.4 GHz, 2MB cache, 6W), DisplayPort, LVDS, 2 GbE LANs, 2 USB 2.0, 2 USB 3.0 and heatsink
PICO318PGGA-N4200 (P/N: E38H318103)	Pico-ITX SBC with Intel® Pentium® processor N4200 (1.1 to 2.5 GHz, 2MB cache, 6W), DisplayPort, LVDS, 2 GbE LANs, 2 USB 2.0, 2 USB 3.0 and heatsink
7128H316000E	Heatspreader
594H3160410E	Power cable for adapter, L=100mm
50966124030E	Adapter 12V 60W FSP060-DIBAN2 with screw.
59312260020E	Audio cable with bracket, P=1.25 mm, L=450 mm
59380880250E	COM port cable DB9-9 x 1-pin, P=1.25 mm, L=250 mm
59382631000E	2 x USB 2.0 cable with bracket, L=180 mm
594H3186800E	Buzzer cable 9 x 5.5 mm 2-pin, L=40mm



# PICO319 NEW

Pico-ITX SBC with Intel® Atom® x5-E3940 Processor, DisplayPort, LVDS, 2 GbE LANs and Audio

## Features

- Intel® Atom® x5-E3940 processor
- 1 DDR3L SO-DIMM for up to 8GB of memory
- 2 USB 2.0 and 2 USB 3.0
- 1 PCI Express Mini card slot with mSATA supported
- 1 M.2 Key B

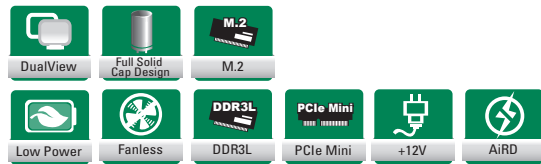

### Core System

CPU	Intel® Atom® x5-E3940 processor onboard
System Memory	1 x 204-pin DDR3L-1867 SO-DIMM, up to 8GB
Chipset	SoC integrated
BIOS	AMI
SSD	1 x M.2 Key B (SATA, USB 2.0, PCIe x2 optional) in 22 x 42 or 30 x 42
Watchdog Timer	65536 levels, 1 to 65535 sec.
Expansion Interface	1 x Half-size PCI Express Mini Card slot with mSATA supported
Battery Lithium	Lithium 3V/220mAh
Power Input	1x 4 pin connector +12 VDC-in only AT Auto Power On function supported
Power Requirements	TBD
Dimensions	100 x 72 mm
Board Thickness	1.6 mm
Operating Temperature	-40°C to +70°C (-40°F to 158°F)
Humidity	10% to 95% relative humidity, non-condensing

### I/O

SATA	N/A
Hardware Monitoring	Detect CPU/system temperature and voltage
Ethernet	2 x 10/100/1000 Mbps Ethernet with Intel® i211-AT; support Wake-on-LAN, PXE Boot ROM
Audio	HD Codec audio as MIC-in/Line-in/Line out with Realtek ALC662
USB	2 x USB 2.0 2 x USB 3.0
Serial	1 x RS-232/422/485 1 x RS-232
TPM	N/A
SMBus	Yes
Others	1 x I <sup>2</sup> C
Digital I/O	4-channel in/out programmed

### Display

Chipset	Intel® integrated Gfx graphic engine
Memory Size	Share system memory
Display Interface	1 x LVDS; 18/24-bit single/dual channel 1 x DisplayPort

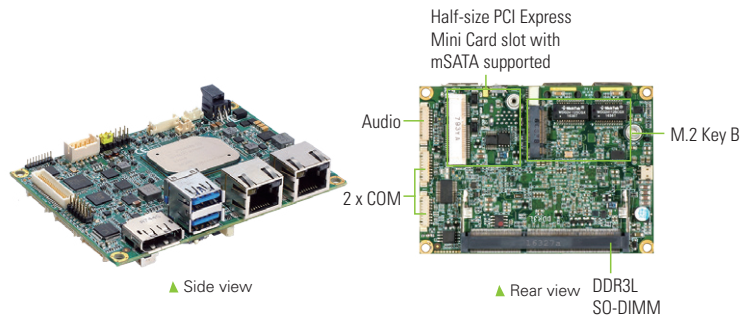
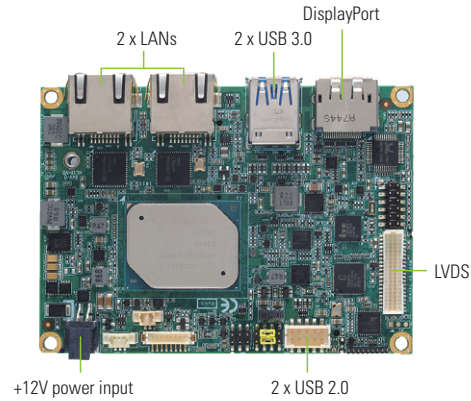

### Packing List

#### Standard

Quick installation guide, User's Manual/Utility CD and accessories

#### Accessories

594H3160400E Power cable, L=100 mm

### Ordering Information

#### Standard

PICO319PGA-E3940 Pico-ITX SBC with Intel® Atom® x5-E3940 processor, DisplayPort, LVDS, 2 GbE LANs, 2 USB 2.0, and 2 USB 3.0 without heatsink

#### Optional



PICO319PGA-E3940 70°C	Pico-ITX SBC with Intel® Atom® processor x5-E3940 (1.6 to 1.8 GHz, 2MB cache, 9.5W), DisplayPort, LVDS, 2 GbE LANs, 2 USB 2.0, 2 USB 3.0 and heatsink
7128H316000E	Heatspreader
594H3160410E	Power cable for adapter, L=100mm
50966124030E	Adapter 12V 60W FSP060-DIBAN2 with screw.
59312260020E	Audio cable with bracket, P=1.25 mm, L=450 mm
59380880250E	COM port cable DB9-9 x 1-pin, P=1.25 mm, L=250 mm
59382631000E	2 x USB 2.0 cable with bracket, L=180 mm
594H3186800E	Buzzer cable 9 x 5.5 mm 2-pin, L=40 mm



# 4

## Mini-ITX Motherboards

Mini ITX motherboards are designed with rich functionality and reliable performance in a small footprint that measures just 170 x 170 mm. Mini ITX Motherboards provide greater flexibility for applications in which compact size and power-efficiency are required, such as kiosks, POS, lottery machines, gaming systems, factory automation, DSA, and more.

Selection Guide		67
MAN0310	Mini-ITX SBC with Intel® Celeron® Processor N3350 & Pentium® Processor N4200, VGA, HDMI, LVDS, USB 3.0, PCI Express Mini Card Slot, M.2, and HD Audio	69
MAN0311	Thin Mini-ITX SBC with Intel® Celeron® Processor N3350, Dual HDMI, LVDS, USB 3.0, PCI Express Mini Card, mSATA and HD Audio	70
 MAN0315	Mini-ITX SBC with Intel® Celeron® Processor J3355 VGA, HDMI, USB 3.0, PCI Express Mini Card Slot, mSATA and HD Audio	71
 MAN0520	Mini-ITX SBC with LGA1151 8th Gen Intel® Core™ i7/i5/i3 Processor, Dual DisplayPort++, HDMI, LVDS, USB 3.0, mSATA, M.2 and HD Audio	72
 MAN0521	Thin Mini-ITX SBC with LGA1151 8th Gen Intel® Core™ i7/i5/i3 Processor, DisplayPort++, HDMI, LVDS, VGA, USB 3.0, M.2 and HD Audio	73

## Boards and Modules

# Mini-ITX Motherboards

## Selection Guide

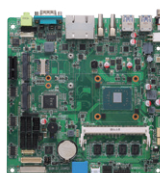

NEW



Features/Models	MANO310	MANO311	MANO315	
<b>Form Factor</b>	Mini-ITX	Mini-ITX	Mini-ITX	
<b>CPU Level</b>	Intel® Celeron® N3350 Intel® Pentium® N4200 (optional)	Intel® Celeron® N3350	Intel® Celeron® J3355	
<b>CPU Socket</b>	Onboard	Onboard	Onboard	
<b>CPU FSB Frequency</b>	N/A	N/A	N/A	
<b>Core Logic Chipset</b>	SoC integrated	SoC integrated	SoC Integrated	
<b>Memory Type</b>	DDR3L-1867	DDR3L-1867	DDR3L-1867	
<b>Max. DRAM Capacity</b>	8GB	8GB	8GB	
<b>Cache RAM Capacity</b>	Integrated in CPU	Integrated in CPU	Integrated in CPU	
<b>BIOS</b>	AMI	AMI	AMI	
<b>Watchdog Timer</b>	255 levels, 1 to 255 sec.	255 levels, 1 to 255 sec.	255 levels, 1 to 255sec.	
<b>SSD</b>	1 x M.2 Key B 22 x 42/60/80 1 x SDXC slot	1 x mSATA 1 x SDXC slot	1 x PCIe x1 1 x PCI Express Mini Card slot	
<b>Digital I/O</b>	16-in/out	16-in/out	N/A	
<b>I/O</b>	<b>SATA</b>	1 x SATA-600	1 x SATA-600	
	<b>Serial</b>	<b>COM 1</b>	RS-232/422/485	RS-232
		<b>COM 2</b>	RS-232/422/485	RS-232
		<b>COM 3</b>	RS-232	RS-232
		<b>COM 4</b>	RS-232	RS-232
		<b>COM 5</b>	RS-232	N/A
		<b>COM 6</b>	RS-232	N/A
<b>USB</b>	2 x USB 2.0, 4 x USB 3.0	2 x USB 2.0, 4 x USB 3.0	4 x USB 2.0; 2 x USB 3.0	
<b>IrDA</b>	N/A	N/A	N/A	
<b>SIM Card Slot</b>	1 x SIM	1 x SIM	N/A	
<b>IEEE 1394a</b>	N/A	N/A	N/A	
<b>Display</b>	1 x VGA 1 x HDMI 1 x LVDS	2 x HDMI 1 x LVDS	1 x VGA 1 x HDMI	
<b>Ethernet</b>	2 x 10/100/1000 Mbps Ethernet	2 x 10/100/1000 Mbps Ethernet	2 x 10/100/1000 Mbps Ethernet	
<b>Audio</b>	HD Codec	HD Codec	HD codec	
<b>Hardware Monitoring</b>	Yes	Yes	Yes	
<b>SMBus</b>	N/A	N/A	N/A	
<b>Expansion Interface</b>	1 x PCI Express Mini Card slot 1 x PCIe x1	1 x PCI Express Mini Card slot 1 x PCIe x1	1 x PCI Express Mini Card Slot 1 x PCIe x1	
<b>Power Management</b>	ACPI	ACPI	ACPI	
<b>Battery</b>	Lithium	Lithium	Lithium	
<b>Operating Temperature</b>	0°C to +60°C (+32°F to +140°F)	0°C to +60°C (+32°F to +140°F)	0°C to +60°C (+32°F to +140°F)	
<b>Relative Humidity</b>	10% to 95%, non-condensing	10% to 95%, non-condensing	10% to 95%, non-condensing	
<b>EMI Compliance</b>	CE	CE	CE	

NEW



NEW

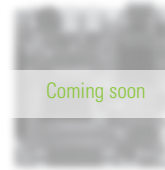

Features/Models	MANO520	MANO521		
<b>Form Factor</b>	Mini-ITX	Mini-ITX		
<b>CPU Level</b>	8th gen Intel® Core™ i7/i5/i3, Pentium® & Celeron®	8th gen Intel® Core™ i7/i5/i3, Pentium® & Celeron®		
<b>CPU Socket</b>	LGA1151	LGA1151		
<b>CPU FSB Frequency</b>	N/A	N/A		
<b>Core Logic Chipset</b>	Intel® H310, Q370 (optional)	Intel® H310, Q370 (optional)		
<b>Memory Type</b>	DDR4-2400/2666	DDR4-2400/2666		
<b>Max. DRAM Capacity</b>	32GB	32GB		
<b>Cache RAM Capacity</b>	Integrated in CPU	Integrated in CPU		
<b>BIOS</b>	AMI	AMI		
<b>Watchdog Timer</b>	255 levels, 1 to 255sec.	255 levels, 1 to 255sec.		
<b>SSD</b>	1 x mSATA	1 x mSATA		
<b>Digital I/O</b>	8-in/out	8-in/out		
<b>I/O</b>	<b>SATA</b>	3 x SATA-600	2 x SATA-600	
	<b>Serial</b>	<b>COM 1</b>	RS-232/422/485	RS-232/422/485
		<b>COM 2</b>	RS-232	RS-232
		<b>COM 3</b>	RS-232	N/A
		<b>COM 4</b>	RS-232	N/A
		<b>COM 5</b>	N/A	N/A
		<b>COM 6</b>	N/A	N/A
<b>USB</b>	4 x USB 3.0; 4 x USB 2.0	4 x USB 3.0; 4 x USB 2.0		
<b>IrDA</b>	N/A	N/A		
<b>SIM Card Slot</b>	N/A	N/A		
<b>IEEE 1394a</b>	N/A	N/A		
<b>Display</b>	2 x Display Port++ 1 x HDMI 1 x LVDS	1 x Display Port++ 1 x HDMI 1 x LVDS 1 x VGA 1 x eDP (optional)		
<b>Ethernet</b>	2 x 10/100/1000 Mbps Ethernet	2 x 10/100/1000 Mbps Ethernet		
<b>Audio</b>	HD codec	HD codec		
<b>Hardware Monitoring</b>	Yes	Yes		
<b>SMBus</b>	N/A	N/A		
<b>Expansion Interface</b>	1 x PCI Express Mini Card Slot 1 x M.2 KEY E 1 x PCIe x16	1 x PCI Express Mini Card Slot 1 x M.2 KEY B 1 x M.2 KEY E 1 x PCIe x4		
<b>Power Management</b>	ACPI	ACPI		
<b>Battery</b>	Lithium	Lithium		
<b>Operating Temperature</b>	0°C to +60°C (+32°F to +140°F)	0°C to +60°C (+32°F to +140°F)		
<b>Relative Humidity</b>	10% to 95%, non-condensing	10% to 95%, non-condensing		
<b>EMI Compliance</b>	CE	CE		

Mini-ITX  
Motherboards

1

2

3

4

5

6

7

8

# MANO310

Mini-ITX SBC with Intel® Celeron® Processor N3350 & Pentium® Processor N4200, VGA, HDMI, LVDS, USB 3.0, PCI Express Mini Card Slot, M.2, and HD Audio

## Features

- Intel® Celeron® N3350 & Pentium® N4200 (optional)
- 2 DDR3L SO-DIMM for up to 8GB of memory
- 1 PCI Express Mini Card slot and PCIe x1
- 4 USB 3.0 and 2 USB 2.0
- 1 SATA-600, 1 M.2 and 1 SDXC slot
- 6 COM supported
- 12 to 24 VDC
- VGA, HDMI and LVDS with triple-view supported

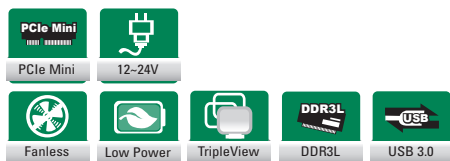
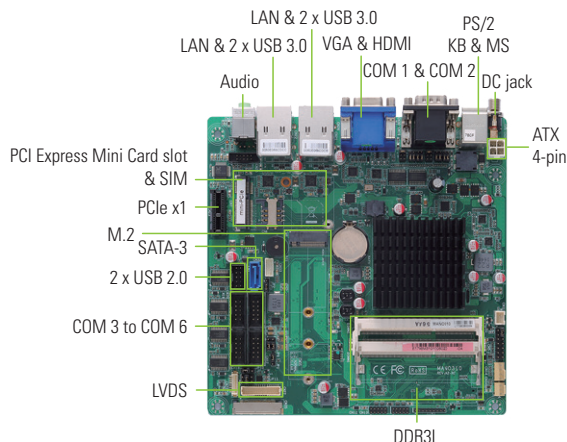

## Core System

CPU	Intel® Celeron® N3350 & Pentium® N4200 (optional)
System Memory	2 x 204-pin DDR3L-1867 SO-DIMM dual channel, up to 8GB
Chipset	SoC integrated
BIOS	AMI
SSD	1 x M.2 Key B 22 x 42/60/80 1 x SDXC slot
Watchdog Timer	255 levels, 1 to 255 sec.
Expansion Interface	1 x PCIe x1 1 x PCI Express Mini Card slot 1 x SIM card slot
Battery	Lithium 3V/220 mAh
Power Input	12 to 24 VDC
Dimensions	170 x 170 mm
Board Thickness	1.6 mm
Operating Temperature	0°C to +60°C (+32°F to +140°F)
Humidity	10% to 95% relative humidity, non-condensing

## I/O

SATA	1 x SATA-600
Ethernet	2 x 10/100/1000 Mbps Ethernet with Realtek RTL8111F; support Wake-on-LAN, PXE Boot ROM
Audio	HD Codec audio as Mic-in/Line-out with Realtek ALC662
USB	2 x USB 2.0 (internal) 4 x USB 3.0 (rear I/O)
Serial	2 x RS-232/422/485 (Rear I/O) 4 x RS-232 (COM 3 with +5/+12V)
PS/2 Combo Port	1 x PS/2 keyboard and mouse
TPM	N/A
SMBus	N/A
Digital I/O	16-channel in/out programmable

## Display

Chipset	Intel® integrated Gfx graphic engine
Memory Size	Shared memory
Display Interface	1 x VGA 1 x HDMI 1 x LVDS; 18/24-bit dual channel

## Packing List

<b>Standard</b>	User's manual/utility CD and I/O bracket/heatsink
-----------------	---

## Ordering Information

<b>Standard</b>	
MANO310VHGGGA-N3350 (P/N: E38M310104)	Mini-ITX SBC with Intel® Celeron® processor N3350 (1.1 to 2.4 GHz, 2MB cache, 6W), VGA, HDMI, LVDS, 2 GbE LANs, 6 COM, USB 3.0, M.2, PCI Express Mini Card slot and HD audio
<b>Optional</b>	
MANO310VHGGGA-N4200	Mini-ITX SBC with Intel® Pentium® processor N4200 (1.1 to 2.5 GHz, 2MB cache, 6W), VGA, HDMI, LVDS, 2 GbE LANs, 6 COM, USB 3.0, M.2, PCI Express Mini Card slot and HD audio
594P8800600E	SATA power cable 4-pin to 15-pin, P=2.0 mm, L=200 mm
59386831000E	2 x USB, 2 x 5P 2.54 mm, L=180 mm
59380703000E	2 x COM port with bracket, P=2.54 mm

# MANO311

Thin Mini-ITX SBC with Intel® Celeron® Processor N3350, Dual HDMI, LVDS, USB 3.0, PCI Express Mini Card, mSATA and HD Audio

## Features

- Intel® Celeron® processor N3350
- 1 DDR3L SO-DIMM for up to 8GB of memory
- 4GB DDR3L onboard memory (optional)
- 1 PCI Express Mini Card slot and PCIe x1
- 4 USB 3.0 and 2 USB 2.0
- 1 SATA-600, 1 mSATA and 1 SDXC
- 6 COM supported
- Low profile

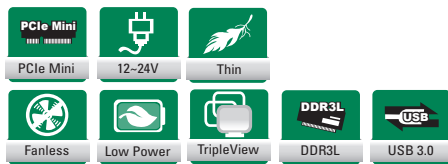

### Core System

CPU	Intel® Celeron® processor N3350
System Memory	1 x 204-pin DDR3L-1867 SO-DIMM, up to 8GB 4GB onboard memory (optional)
Chipset	SoC integrated
BIOS	AMI
SSD	1 x mSATA 1 x SDXC slot
Watchdog Timer	255 levels, 1 to 255 sec.
Expansion Interface	1 x PCIe x1 1 x PCI Express Mini Card slot 1 x SIM card slot
Battery	Lithium 3V/220 mAh
Power Input	1 x DC Jack 12V/5A adapter 1 x 4-pin connector +12 to 24V DC-in
Dimensions	170 x 170 mm
Board Thickness	1.6 mm
Operating Temperature	0°C to +60°C (+32°F to +140°F)
Humidity	10% to 95% relative humidity, non-condensing

### I/O

SATA	1 x SATA-600
Ethernet	2 x 10/100/1000 Mbps Ethernet with Realtek RTL8111F; support Wake-on-LAN, PXE Boot ROM
Audio	HD Codec audio as Mic-in/Line-out with Realtek ALC662
USB	2 x USB 2.0 (internal) 4 x USB 3.0 (rear I/O)
Serial	1 x RS-232/422/485 (rear I/O) 5 x RS-232 (COM 2 with +5/+12V powered)
PS/2 Combo Port	1 x PS/2 keyboard and mouse
TPM	N/A
SMBus	N/A
Digital I/O	16-channel in/out programmable

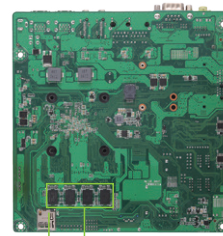
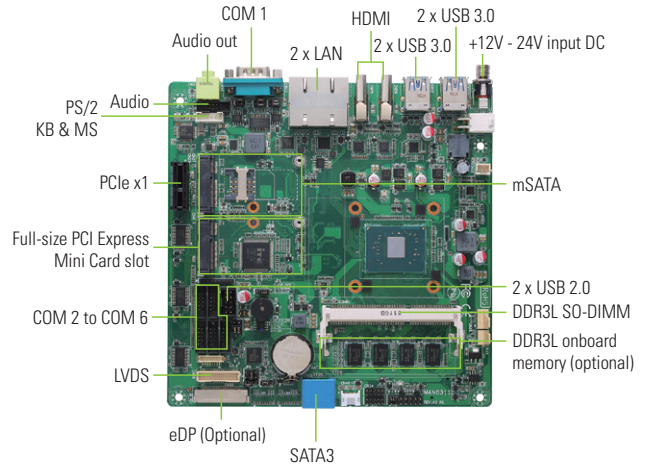

SDXC slot  
DDR3L memory  
▲ Rear view

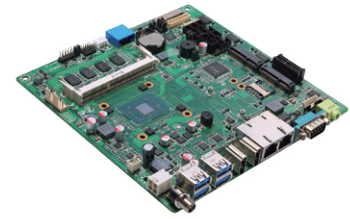

▲ Side view

### Display

Chipset	Intel® integrated Gfx graphic engine
Memory Size	Shared memory
Display Interface	2 x HDMI 1 x LVDS; 18/24-bit dual channel 1 x eDP (optional)

### Packing List

<b>Standard</b>	User's manual/utility CD/heatsink
-----------------	-----------------------------------

### Ordering Information

<b>Standard</b>	MANO311HGGA-N3350 (P/N: E38M311100)	Mini-ITX SBC with Intel® Celeron® processor N3350 (1.1 to 2.4 GHz, 2MB cache, 6W), 2 HDMI, LVDS, 2 GbE LANs, 6 COM, USB 3.0, mSATA, PCI Express Mini Card slot and HD audio
-----------------	-------------------------------------	---

<b>Optional</b>	594P8800600E	SATA power cable, 4-pin to 15-pin, P=2.0 mm, L=200 mm
	59382620000E	COM port cable, P=2.0 mm, L=300 mm
	594M5002A00E	6-pin wafer to PS/2 cable, P=2.0 mm, L=200 mm
	59384500100E	Audio cable with bracket, P=2.0 mm, L=420 mm
	59386831000E	2-port USB cable with bracket, 5-pin header, P=2.54 mm, L=180 mm
	59381560000E	6-pin PS/2 cable adapter



# MANO315 NEW

Mini-ITX SBC with Intel® Celeron® Processor J3355 VGA, HDMI, USB 3.0, PCI Express Mini Card Slot, mSATA and HD Audio

## Features

- Intel® Celeron® processor J3355 (Apollo Lake)
- DDR3L SO-DIMM for up to 8GB of memory
- 1 PCI Express Mini Card slot and PCIe x1
- 2 USB 3.0 and 4 USB 2.0
- 1 SATA-600 and 1 mSATA
- 4 COM supported
- STD ATX Power
- VGA and HDMI supported



### Core System

CPU	Intel® Celeron® J3355
System Memory	1 x 204-pin DDR3L-1867 SO-DIMM dual channel, up to 8GB
Chipset	SoC integrated
BIOS	AMI
SSD	1 x mSATA
Watchdog Timer	255 levels, 1 to 255 sec.
Expansion Interface	1 x PCIe x1 1 x PCI Express Mini Card slot
Battery	Lithium 3V/220 mAH
Power Input	STD ATX
Dimensions	170 x 170 mm
Board Thickness	1.6 mm
Operating Temperature	0°C to +60°C (+32°F to +140°F)
Humidity	10% to 95% relative humidity, non-condensing

### I/O

SATA	1 x SATA-600
Ethernet	2 x 10/100/1000 Mbps Ethernet with Realtek RTL8111F; support Wake-on-LAN, PXE Boot ROM
Audio	HD Codec audio as Mic-in/Line-out with Realtek ALC662
USB	2 x USB 2.0 (internal) 2 x USB 3.0 2 x USB 2.0 (rear I/O)
Serial	2 x RS-232 (rear I/O with +5V supported) 2 x RS-232
PS/2 Combo Port	1 x PS/2 keyboard and mouse
TPM	N/A
SMBus	N/A
Digital I/O	N/A

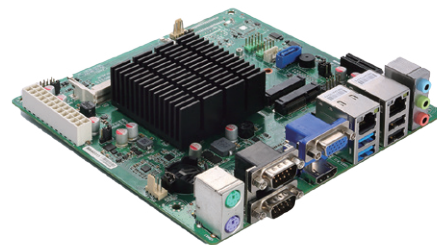
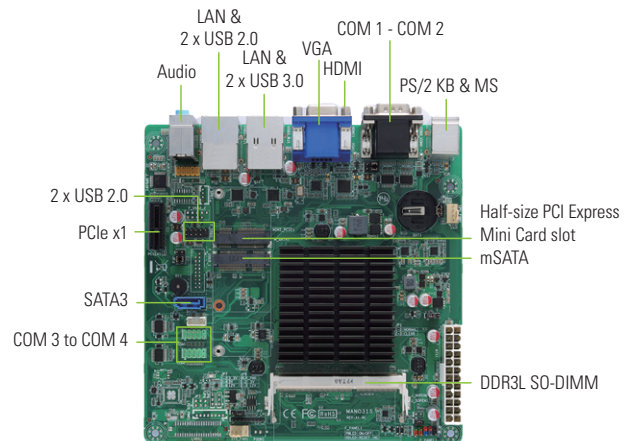

▲ Side view

### Display

Chipset	Intel® integrated Gfx graphic engine
Memory Size	Shared memory
Display Interface	1 x VGA 1 x HDMI

### Packing List

<b>Standard</b>	User's manual/utility CD and I/O bracket/heatsink
-----------------	---

### Ordering Information

<b>Standard</b>	
MANO315VHGA-J3355	Mini-ITX SBC with Intel® Celeron® processor J3355 (2.0 to 2.5 GHz, 2MB cache, 10W), VGA, HDMI, 2 GbE LANs, 4 COM, USB 3.0, PCI Express Mini Card slot and HD audio

<b>Optional</b>	
593M8810300E	COM port cable, P=2.0 mm, L=300 mm
594M5002A00E	6-pin wafer to PS/2 cable, P=2.0 mm, L=200 mm
59384500100E	Audio cable with bracket, P=2.0 mm, L=420 mm
59386831000E	2-port USB cable with bracket, 5-pin header, P=2.54 mm, L=180 mm
594P8800600E	SATA power cable, 4-pin to 15-pin, P=2.0 mm, L=200 mm
593M8400400E	Audio cable, P=2.54 mm, L=300 mm

# MANO520 NEW

Mini-ITX SBC with LGA1151 8th Gen Intel® Core™ i7/i5/i3 Processor, Dual DisplayPort++, HDMI, LVDS, USB 3.0, mSATA, M.2 and HD Audio

## Features

- LGA1151 8th gen Intel® Core™ i7/i5/i3 processor
- Intel® H310 chipset (Q370 optional)
- 2 DDR4 SO-DIMM for up to 32GB of memory
- 4 USB 3.0 and 4 USB 2.0
- 4 COM ports
- 3 SATA-600 and 1 mSATA
- PCIe x16 and M.2 Key E
- 2 DisplayPort, 1 HDMI, 1 LVDS with triple-view supported

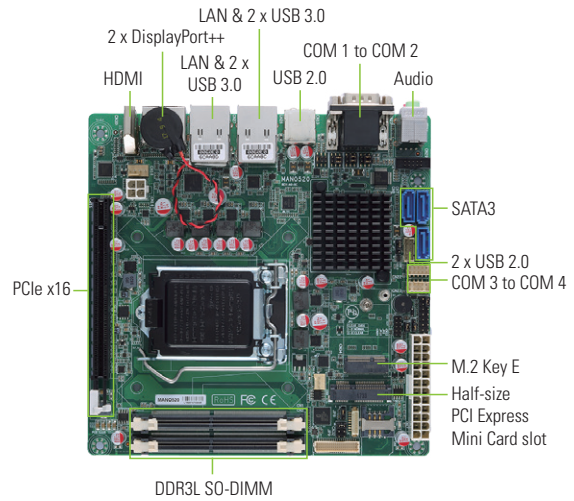

## Core System

CPU	LGA1151 8th gen Intel® Core™ i7/i5/i3, Intel® Pentium® processors Gold/Celeron® processors
System Memory	2 x 260-pin DDR4-2666 SO-DIMM up to 32GB
Chipset	Intel® H310 Intel® Q370 (optional)
BIOS	AMI
SSD	1 x mSATA
Watchdog Timer	255 levels, 1 to 255 sec.
Expansion Interface	1 x PCIe x16 1 x M.2 Key E 22 x 30
Battery Lithium	Lithium 3V/220mAh
Power Input	2x12 ATX connector ATX power AT Auto Power On function supported
Dimensions	170 x 170 mm
Board Thickness	1.6 mm
Operating Temperature	0°C to +60°C (+32°F to +140°F)
Humidity	10% to 95% relative humidity, non-condensing

## I/O

SATA	3 x SATA-600
Hardware Monitoring	Detect CPU/system temperature, voltage and fan speed
Ethernet	1 x 10/100/1000 Mbps Ethernet with Intel® i211-AT; supports Wake-on-LAN, PXE Boot ROM 1 x 10/100/1000 Mbps Ethernet with Intel® i219-LM; supports Wake-on-LAN, PXE Boot ROM
Audio	HD Codec audio as MIC-in/Line-in/Line-out with Realtek ALC662
USB	4 x USB 3.0 4 x USB 2.0
Serial	1 x RS-232/422/485 3 x RS-232
PS/2 Combo Port	N/A
TPM	Onboard TPM 2.0 (optional)
SMBus	N/A
Digital I/O	8-channel in/out programmed

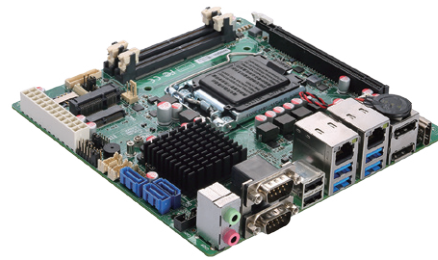

▲ Side view

## Display

Chipset	Intel® integrated Gfx graphic engine
Memory Size	Share system memory
Display Interface	2 x DisplayPort++ 1 x HDMI 1 x LVDS; 18/24-bit single/dual channel

## Packing List

<b>Standard</b>	User's Manual/Utility CD and I/O bracket/heatsink
-----------------	---

## Ordering Information

<b>Standard</b>	
MANO520PHGGA-H310	Mini-ITX SBC with LGA1151 8th gen Intel® Core™ processor, Intel® H310, DP++, HDMI, LVDS, 2 GbE LANs and audio
<b>Optional</b>	
MANO520PHGGA-Q370	Mini-ITX SBC with LGA1151 8th gen Intel® Core™ processor, Intel® Q370, DP++, HDMI, LVDS, 4 COM, USB 3.0, M.2, mSATA, 2 GbE LANs and HD audio
594M5002100E	2 COM port, P=2.0 mm, L=300 mm
59384500100E	SBC84500 audio cable with bracket, P=2.0 mm, L=420 mm
59382631000E	2 x SBC82631 USB 2.0 cable with bracket, L=180 mm

# MANO521 NEW

Thin Mini-ITX SBC with LGA1151 8th Gen Intel® Core™ i7/i5/i3 Processor, DisplayPort++, HDMI, LVDS, VGA, USB 3.0, M.2 and HD Audio

## Features

- LGA1151 8th gen Intel® Core™ i7/i5/i3 processor
- Intel® H310 chipset (Q370 optional)
- 2 DDR4 SO-DIMM for up to 32GB of memory
- 4 USB3.0 and 4 USB 2.0 ports
- 2 COM ports
- 2 SATA-600 and M.2 Key B
- PCIe x4, M.2 KEY E, PCI Express Mini Card slot

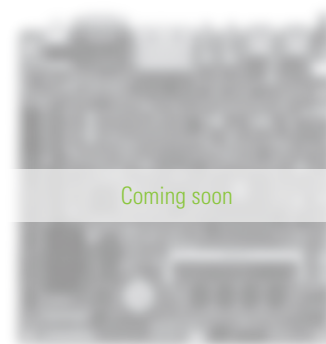

Coming soon



### Core System

CPU	LGA1151 8th gen Intel® Core™ i7/i5/i3, Intel® Pentium® processors Gold/Celeron® processors
System Memory	2 x 260-pin DDR4-2666 SO-DIMM, up to 32GB
Chipset	Intel® H310 Intel® Q370 (optional)
BIOS	AMI
SSD	1 x M.2 Key B 22 x 42/22 x 80
Watchdog Timer	255 levels, 1 to 255 sec.
Expansion Interface	1 x PCIe x4 1 x M.2 Key E 22 x 30 1 x Full-size PCI Express Mini Card
Battery Lithium	Lithium 3V/220mAh
Power Input	DC Power Jack connector/ATX 2 x 2-pin connector support 12V, 19 to 24 VDC input AT Auto Power On function supported
Dimensions	170 x 170 mm
Board Thickness	1.6 mm
Operating Temperature	0°C to +60°C (+32°F to +140°F)
Humidity	10% to 95% relative humidity, non-condensing

### I/O

SATA	2 x SATA-600
Hardware Monitoring	Detect CPU/system temperature, voltage and fan speed
Ethernet	1 x 10/100/1000 Mbps Ethernet with Intel® i211-AT; supports Wake-on-LAN, PXE Boot ROM 1 x 10/100/1000 Mbps Ethernet with Intel® i219-LM; supports Wake-on-LAN, PXE Boot ROM
Audio	HD Codec audio as MIC-in/Line-in/Line-out with Realtek ALC662
USB	4 x USB 3.0 4 x USB 2.0
Serial	1 x RS-232/422/485 1 x RS-232
PS/2 Combo Port	N/A
TPM	Infenon SLB9665TT2.0 with TPM 2.0 compliant (optional)
SMBus	N/A
Digital I/O	8-channel in/out programmed

### Display

Chipset	Intel® integrated Gfx graphic engine
Memory Size	Share system memory
Display Interface	1 x DisplayPort++ 1 x HDMI 1 x LVDS; 18/24-bit single/dual channel 1 x VGA (Wafer connector) 1 x eDP (optional)

### Packing List

<b>Standard</b>	User's Manual/Utility CD and I/O bracket/heatsink
-----------------	---

### Ordering Information

<b>Standard</b>	
MANO521PHGGA-H310	Mini-ITX SBC with LGA1151, 8th gen Intel® Core™ processor, Intel® H310, DP++, HDMI, LVDS, VGA, 2 COM, USB 3.0, M.2, mSATA, PCI Express Mini Card, 2 GbE LANs and HD audio

<b>Optional</b>	
MANO521PHGGA-Q370	Mini-ITX SBC with LGA1151, 8th gen Intel® Core™ processor, Intel® Q370, DP++, HDMI, LVDS, VGA, 2 COM, USB 3.0, M.2, mSATA, PCI Express Mini Card, 2 GbE LANs and HD audio
5938A808010E	2 USB cables with bracket, 2 x 5 (10P-KEY)
59382G20000E	COM port with bracket, P=2 mm
59406200640E	SATA Power 15P to housing-2.54P, L=20 cm
59384500100E	SBC84500 audio cable with bracket, P=2.0 mm, L=420 mm

# 5

## ATX & Micro ATX Motherboards

Axiomtek's high performance ATX motherboards (305 x 244 mm) support a wide range of computing capacities and rich I/O and expansion slots. The Micro ATX motherboards (244 x 244 mm) support a wide range of computing capacities and rich I/O and expansion slots. The industrial Micro ATX motherboard is suited for space/cost sensitive applications where less than 4 slots are required. The industrial ATX and Micro ATX motherboards are ideal platforms for applications in digital video recorder, POS system, intelligent transportation system, multi-media center and more.

Selection Guide		75
IMB500	ATX Motherboard with LGA1151 Socket 7th/6th Gen Intel® Core™ Processor, Intel® Q170, USB 3.0, SATA 3.0, Dual LANs, VGA, DisplayPort, HDMI and mSATA	78
IMB501	ATX Motherboard with LGA1151 Socket 7th/6th Gen Intel® Core™ Processor, Intel® H110, USB 3.0, SATA 3.0, Dual LANs, VGA, DisplayPort, HDMI and mSATA	79
IMB502	ATX Motherboard with LGA1151 Socket 7th/6th Gen Intel® Core™ Processor, Intel® Q170, USB 3.0, SATA 3.0, Dual LANs, VGA, DVI-D and HDMI	80
 IMB520	ATX Motherboard with LGA1151 Socket 8th Gen Intel® Core™ Processor, Intel® Q370, USB 3.1 Gen2, SATA 3.0, Dual LANs, VGA, DP, DVI-D, and HDMI	81
 IMB521	ATX Motherboard with LGA1151 Socket 8th Gen Intel® Core™ Processor, Intel® C246, ECC DDR4, USB 3.0, SATA 3.0, Dual LANs, VGA, DP, DVI-D, and HDMI	82
 IMB523	ATX Motherboard with LGA1151 Socket 8th Gen Intel® Core™ Processor, Intel® Q370, USB 3.1 Gen2, SATA 3.0, Dual LANs, VGA, DP, DVI-D, and HDMI	83
 IMB524	ATX Motherboard with LGA1151 Socket 8th Gen Intel® Core™ Processor, Intel® H310, USB 3.1 Gen1, SATA 3.0, Dual LANs, VGA, DP, DVI-D, and HDMI	84
 IMB525	ATX Motherboard with LGA1151 Socket 8th Gen Intel® Core™ Processor, Intel® C246, ECC DDR4, USB 3.1 Gen, SATA 3.0, Dual LANs, VGA, DP, DVI-D, and HDMI	85
IMB210	ATX Motherboard with LGA1150 Socket Intel® Xeon® E3-v3 Processor, Intel® C226, ECC DDR3, USB 3.0, SATA 3.0, Dual LANs, DisplayPort, DVI-I, HDMI and CFast™	86
IMB211	ATX Motherboard with LGA1150 Socket 4th Gen Intel® Core™ Processor, Intel® Q87, USB 3.0, SATA 3.0, Dual LANs, DisplayPort, VGA, HDMI and mSATA	87
MMB501	Micro ATX Motherboard with LGA1151 Socket 7th/6th Gen Intel® Core™ Processor, Intel® Q170, USB 3.0, SATA 3.0, Dual LANs, VGA, DP, DVI-D, and HDMI	88

# ATX Motherboards

## Selection Guide

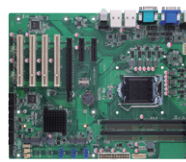
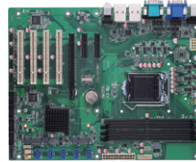

Features/Models	IMB500	IMB501	IMB502
<b>Form Factor</b>	ATX	ATX	ATX
<b>CPU Level</b>	7th/6th gen Intel® Core™ i7/i5/i3 & Celeron®	7th/6th gen Intel® Core™ i7/i5/i3 & Celeron®	7th/6th gen Intel® Core™ i7/i5/i3 & Celeron®
<b>CPU Socket</b>	LGA1151	LGA1151	LGA1151
<b>CPU FSB Frequency</b>	N/A	N/A	N/A
<b>Core Logic Chipset</b>	Intel® Q170	Intel® H110	Intel® Q170
<b>Memory Type</b>	DDR4-2133/2400	DDR4-2133/2400	DDR4-2133/2400
<b>Max. DRAM Capacity</b>	64GB	32GB	64GB
<b>Cache RAM Capacity</b>	Integrated in CPU	Integrated in CPU	Integrated in CPU
<b>BIOS</b>	AMI UEFI BIOS with OA 3.0 built	AMI UEFI BIOS with OA 3.0 built	AMI UEFI BIOS with OA 3.0 built
<b>Watchdog Timer</b>	255 levels, 1 to 255 sec.	255 levels, 1 to 255 sec.	255 levels, 1 to 255 sec.
<b>SSD</b>	N/A	N/A	N/A
<b>Digital I/O</b>	4-in & 4-out	4-in & 4-out	8-channel programmable
<b>I/O</b>			
<b>IDE</b>	N/A	N/A	N/A
<b>SATA</b>	5 x SATA-600 1 x mSATA	3 x SATA-600 1 x mSATA	5 x SATA-600
<b>FDD</b>	N/A	N/A	N/A
<b>LPT</b>	N/A	N/A	N/A
<b>Serial</b>			
<b>COM 1</b>	RS-232/422/485	RS-232/422/485	RS-232/422/485
<b>COM 2</b>	RS-232/422/485	RS-232/422/485	RS-232
<b>COM 3</b>	RS-232	RS-232	RS-232
<b>COM 4</b>	RS-232	RS-232	RS-232
<b>COM 5</b>	RS-232	RS-232	RS-232
<b>COM 6</b>	RS-232	RS-232	RS-232
<b>USB</b>	8 x USB 2.0, 4 x USB 3.0	4 x USB 2.0, 4 x USB 3.0	6 x USB 3.0, 7 x USB 2.0
<b>IrDA</b>	N/A	N/A	N/A
<b>SIM Card Slot</b>	1 x SIM	1 x SIM	N/A
<b>IEEE 1394a</b>	N/A	N/A	N/A
<b>Display</b>	1 x VGA 1 x DisplayPort 1 x HDMI	1 x VGA 1 x DisplayPort 1 x HDMI	1 x VGA 1 x DVI-D 1 x HDMI
<b>Ethernet</b>	2 x 10/100/1000 Mbps Ethernet	2 x 10/100/1000 Mbps Ethernet	2 x 10/100/1000 Mbps Ethernet
<b>Audio</b>	HD Codec	HD Codec	HD Codec
<b>Hardware Monitoring</b>	Yes	Yes	Yes
<b>SMBus</b>	Yes	Yes	Yes
<b>Expansion Interface</b>	4 x PCI 2 x PCIe x4 1 x PCIe x16 1 x PCI Express Mini Card slot 1 x SIM slot	4 x PCI 2 x PCIe x1 1 x PCIe x16 1 x PCI Express Mini Card slot 1 x SIM slot	1 x PCIe x16 3 x PCIe x4 3 x PCI
<b>Power Management</b>	ACPI	ACPI	ACPI
<b>Battery</b>	Lithium	Lithium	Lithium
<b>Operating Temperature</b>	0°C to +60°C (+32°F to +140°F)	0°C to +60°C (+32°F to +140°F)	0°C to +60°C (+32°F to +140°F)
<b>Relative Humidity</b>	10% to 95%, non-condensing	10% to 95%, non-condensing	10% to 95%, non-condensing
<b>EMI Compliance</b>	CE	CE	CE



NEW



NEW



NEW

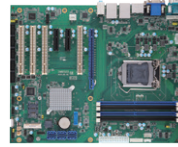

Features/Models	IMB520	IMB521	IMB523
<b>Form Factor</b>	ATX	ATX	ATX
<b>CPU Level</b>	8th gen Intel® Core™ i7/i5/i3, Celeron® & Pentium®	8th gen Intel® Core™ i7/i5/i3, Celeron® & Pentium®	8th gen Intel® Core™ i7/i5/i3, Celeron® & Pentium®
<b>CPU Socket</b>	LGA1151	LGA1151	LGA1151
<b>CPU FSB Frequency</b>	N/A	N/A	N/A
<b>Core Logic Chipset</b>	Intel® Q370	Intel® C246	Intel® Q370
<b>Memory Type</b>	DDR4-2400	DDR4-2400	DDR4-2400
<b>Max. DRAM Capacity</b>	64GB	64GB	64GB
<b>Cache RAM Capacity</b>	Integrated in CPU	Integrated in CPU	Integrated in CPU
<b>BIOS</b>	AMI UEFI BIOS with OA 3.0 built	AMI UEFI BIOS with OA 3.0 built	AMI UEFI BIOS with OA 3.0 built
<b>Watchdog Timer</b>	255 levels, 1 to 255 sec.	255 levels, 1 to 255 sec.	255 levels, 1 to 255 sec.
<b>SSD</b>	N/A	N/A	N/A
<b>Digital I/O</b>	8-channel programmable	8-channel programmable	8-channel programmable
<b>I/O</b>			
<b>IDE</b>	N/A	N/A	N/A
<b>SATA</b>	4 x SATA-600	4 x SATA-600	6 x SATA-600
<b>FDD</b>	N/A	N/A	N/A
<b>LPT</b>	N/A	N/A	N/A
<b>Serial</b>			
<b>COM 1</b>	RS-232/422/485	RS-232/422/485	RS-232/422/485
<b>COM 2</b>	RS-232/422/485	RS-232/422/485	RS-232/422/485
<b>COM 3</b>	RS-232	RS-232	RS-232
<b>COM 4</b>	RS-232	RS-232	RS-232
<b>COM 5</b>	RS-232	RS-232	RS-232
<b>COM 6</b>	RS-232	RS-232	RS-232
<b>USB</b>	2 x USB 3.1 Gen2, 4 x USB3.1 Gen1, 7 x USB 2.0	2 x USB 3.1 Gen2, 4 x USB 3.1 Gen1, 7 x USB 2.0	2 x USB 3.1 Gen2, 4 x USB 3.1 Gen1, 7 x USB 2.0
<b>IrDA</b>	N/A	N/A	N/A
<b>SIM Card Slot</b>	N/A	N/A	Optional
<b>IEEE 1394a</b>	N/A	N/A	N/A
<b>Display</b>	1 x VGA 1 x DVI-D 1 x DisplayPort 1 x HDMI	1 x VGA 1 x DVI-D 1 x DisplayPort 1 x HDMI	1 x VGA 1 x DVI-D 1 x DisplayPort 1 x HDMI
<b>Ethernet</b>	2 x 10/100/1000 Mbps Ethernet	2 x 10/100/1000 Mbps Ethernet	2 x 10/100/1000 Mbps Ethernet
<b>Audio</b>	HD Codec	HD Codec	HD Codec
<b>Hardware Monitoring</b>	Yes	Yes	Yes
<b>SMBus</b>	Yes	Yes	Yes
<b>Expansion Interface</b>	1 x PCIe x16 4 x PCIe x4 1 x PCIe x1 1 x PCI	1 x PCIe x16 4 x PCIe x4 1 x PCIe x1 1 x PCI	1 x PCIe x16 2 x PCIe x4 4 x PCI 1 x PCI Express Mini Card slot (optional)
<b>Power Management</b>	ACPI	ACPI	ACPI
<b>Battery</b>	Lithium	Lithium	Lithium
<b>Operating Temperature</b>	0°C to +60°C (+32°F to +140°F)	0°C to +60°C (+32°F to +140°F)	0°C to +60°C (+32°F to +140°F)
<b>Relative Humidity</b>	10% to 95%, non-condensing	10% to 95%, non-condensing	10% to 95%, non-condensing
<b>EMI Compliance</b>	CE	CE	CE

ATX/Micro ATX Motherboards

1  
2  
3  
4  
5  
6  
7  
8

# ATX & Micro ATX Motherboards

## Selection Guide

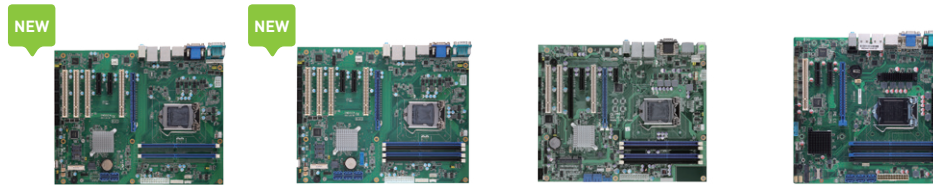

Features/Models	IMB524	IMB525	IMB210	MMB501
<b>Form Factor</b>	ATX	ATX	ATX	Micro ATX
<b>CPU Level</b>	8th gen Intel® Core™ i7/i5/i3, Celeron® & Pentium®	8th gen Intel® Core™ i7/i5/i3, Celeron® & Pentium®	Intel® Xeon® E3-V3, 4th gen Intel® Core™ i7/i5/i3 & Celeron®	7th/6th gen Intel® Core™ i7/i5/i3, Celeron®
<b>CPU Socket</b>	LGA1151	LGA1151	LGA1150	LGA1151
<b>CPU FSB Frequency</b>	N/A	N/A	N/A	N/A
<b>Core Logic Chipset</b>	Intel® H310	Intel® C246	Intel® C226	Intel® Q170
<b>Memory Type</b>	DDR4-2400	DDR4-2400	DDR3-1333/1600	DDR4-2133/1866
<b>Max. DRAM Capacity</b>	32GB	64GB	32GB	64GB
<b>Cache RAM Capacity</b>	Integrated in CPU	Integrated in CPU	Integrated in CPU	Integrated in CPU
<b>BIOS</b>	AMI UEFI BIOS with OA 3.0 built	AMI UEFI BIOS with OA 3.0 built	AMI UEFI BIOS with OA 3.0 built	AMI UEFI BIOS with OA 3.0 built
<b>Watchdog Timer</b>	255 levels, 1 to 255 sec.	255 levels, 1 to 255 sec.	255 levels, 1 to 255 sec.	255 levels, 1 to 255 sec.
<b>SSD</b>	N/A	N/A	1 x CFast™	N/A
<b>Digital I/O</b>	8-channel programmable	8-channel programmable	4-in & 4-out	8-channel programmable
<b>I/O</b>				
<b>IDE</b>	N/A	N/A	N/A	N/A
<b>SATA</b>	4 x SATA-600	6 x SATA-600	5 x SATA-600	6 x SATA-600
<b>FDD</b>	N/A	N/A	N/A	N/A
<b>LPT</b>	N/A	N/A	N/A	N/A
<b>Serial</b>				
<b>COM 1</b>	RS-232/422/485	RS-232/422/485	RS-232/422/485	RS-232/422/485
<b>COM 2</b>	RS-232/422/485	RS-232/422/485	RS-232	RS-232/422/485
<b>COM 3</b>	RS-232	RS-232	RS-232	RS-232
<b>COM 4</b>	RS-232	RS-232	RS-232	RS-232
<b>COM 5</b>	RS-232	RS-232	RS-232	RS-232
<b>COM 6</b>	RS-232	RS-232	RS-232	RS-232
<b>USB</b>	4 x USB 3.1 Gen1, 6 x USB 2.0	2 x USB 3.1 Gen2, 4 x USB 3.1 Gen1, 7 x USB 2.0	6 x USB 2.0, 4 x USB 3.0	5 x USB 2.0, 6 x USB 3.0
<b>IrDA</b>	N/A	N/A	N/A	N/A
<b>SIM Card Slot</b>	optional	optional	N/A	1 x SIM
<b>IEEE 1394a</b>	N/A	N/A	N/A	N/A
<b>Display</b>	1 x VGA 1 x DVI-D 1 x DisplayPort 1 x HDMI	1 x VGA 1 x DVI-D 1 x DisplayPort 1 x HDMI	1 x DVI-I 1 x DisplayPort 1 x HDMI	1 x DVI-I 1 x DisplayPort 1 x HDMI 1 x VGA
<b>Ethernet</b>	2 x 10/100/1000 Mbps Ethernet	2 x 10/100/1000 Mbps Ethernet	2 x 10/100/1000 Mbps Ethernet	2 x 10/100/1000 Mbps Ethernet
<b>Audio</b>	HD Codec	HD Codec	HD Codec	HD Codec
<b>Hardware Monitoring</b>	Yes	Yes	Yes	Yes
<b>SMBus</b>	Yes	Yes	Yes	Yes
<b>Expansion Interface</b>	1 x PCIe x16 2 x PCIe x4 4 x PCI 1 x PCI Express Mini Card slot (optional)	1 x PCIe x16 2 x PCIe x4 4 x PCI 1 x PCI Express Mini Card slot (optional)	3 x PCI 1 x PCIe x1 1 x PCIe x4 1 x PCIe x16 or 2 x PCIe x8	1 x PCI 2 x PCIe x4 1 x PCIe x16 1 x PCI Express Mini Card slot
<b>Power Management</b>	ACPI	ACPI	ACPI	ACPI
<b>Battery</b>	Lithium	Lithium	Lithium	Lithium
<b>Operating Temperature</b>	0°C to +60°C (+32°F to +140°F)	0°C to +60°C (+32°F to +140°F)	0°C to +60°C (+32°F to +140°F)	0°C to +60°C (+32°F to +140°F)
<b>Relative Humidity</b>	10% to 95%, non-condensing	10% to 95%, non-condensing	10% to 95%, non-condensing	10% to 95%, non-condensing
<b>EMI Compliance</b>	CE	CE	CE	CE

# IMB500

ATX Motherboard with LGA1151 Socket 7th/6th Gen Intel® Core™ Processor, Intel® Q170, USB 3.0, SATA 3.0, Dual LANs, VGA, DisplayPort, HDMI and mSATA

## Features

- LGA1151 socket 7th/6th gen Intel® Core™ i7/i5/i3, Pentium® & Celeron® processor (Kaby Lake/Skylake)
- Four 288-pin DDR4-2133/2400 DIMM for up to 64GB of memory
- DisplayPort, HDMI and VGA with triple-view supported
- 5 SATA-600 with RAID 0/1/5/10
- 4 USB 3.0 and 8 USB 2.0
- mSATA supported
- 1 PCI Express Mini Card slot

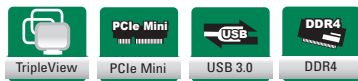
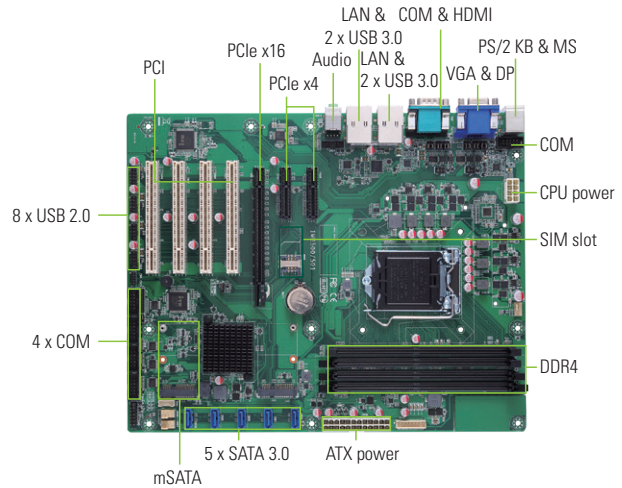

## Core System

CPU	LGA1151 socket 7th/6th gen Intel® Core™ i7/i5/i3, Pentium® & Celeron® processor
System Memory	4 x 288-pin DDR4-2133/2400 DIMM, up to 64GB
Chipset	Intel® Q170
BIOS	AMI BIOS
SSD	N/A
Watchdog Timer	255 levels, 1 to 255 sec.
Expansion Interface	1 x PCIe x16 slot 2 x PCIe x4 slot 4 x PCI slot 1 x PCI Express Mini Card slot 1 x SIM slot
Battery	Lithium 3 V/ 220 mAh
Dimensions	305 x 244 mm
Board Thickness	1.6 mm
Operating Temperature	0°C to +60°C (+32°F to +140°F)
Humidity	10% to 95% relative humidity, non-condensing

## I/O

SATA	5 x SATA-600 with RAID 0/1/5/10 1 x mSATA
Hardware Monitoring	Detect CPU/system temperature, voltage and supports Smart fan control
Ethernet	1x 10/100/1000 Mbps Ethernet with Intel® i219-LM; supports Wake-on-LAN, PXE Boot ROM, iAMT 1 x 10/100/1000 Mbps Ethernet with Intel® i210-AT; supports Wake-on-LAN, PXE Boot ROM
Audio	HD Codec audio as MIC-in/Line-in/Line-out with Realtek ALC662
USB	4 x USB 3.0 8 x USB 2.0
Serial	4 x RS-232 (Internal box header) 2 x RS-232/422/485 (COM 1: rear I/O; COM 2: internal box header)
PS/2 Combo Port	1 x PS/2 keyboard and mouse
TPM	N/A
SMBus	Yes
Digital I/O	8-channel programmable

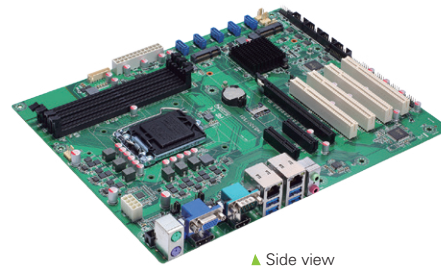

▲ Side view

## Display

Graphic	Intel® HD Graphic
Memory Size	Share system memory
Display Interface	1 x DisplayPort 1 x HDMI 1 x VGA

## Ordering Information

Standard	
IMB500 (P/N: E38F500101)	ATX motherboard with LGA1151 socket 7th/6th gen Intel® Core™ i7/i5/i3, Pentium® & Celeron® processor, Intel® Q170, USB 3.0, SATA 3.0, 2 GbE LANs, VGA, DisplayPort, HDMI and mSATA
Optional	
5938A808010E	2 x USB 2.0 cable with bracket, P=2.54 mm, L=190 mm
5938A808020E	2 x USB 2.0 cable with bracket, P=2.54 mm, L=400 mm
593826A0000E	SATA signal cable/red, L=500 mm
59384500100E	Audio cable with bracket, P=2.0 mm, L=450 mm
59380402010E	1 x COM port cable with bracket, P=2.54 mm, L=300 mm
59380703000E	2 x COM port cable with bracket, P=2.54 mm, L=300 mm

# IMB501

ATX Motherboard with LGA1151 Socket 7th/6th Gen Intel® Core™ Processor, Intel® H110, USB 3.0, SATA 3.0, Dual LANs, VGA, DisplayPort, HDMI and mSATA

## Features

- LGA1151 socket 7th/6th gen Intel® Core™ i7/i5/i3, Pentium® & Celeron® processor (Kaby Lake/Skylake)
- Two 288-pin DDR4-2133/2400 DIMM for up to 32GB of memory
- DisplayPort, HDMI and VGA with dual-view supported
- 3 SATA-600 and 1 mSATA
- 4 USB 3.0 and 4 USB 2.0
- 1 PCI Express Mini Card slot

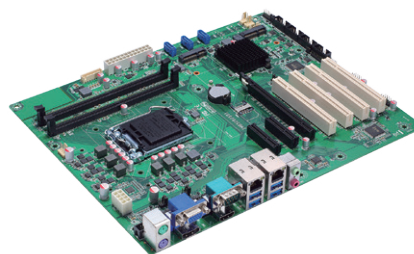
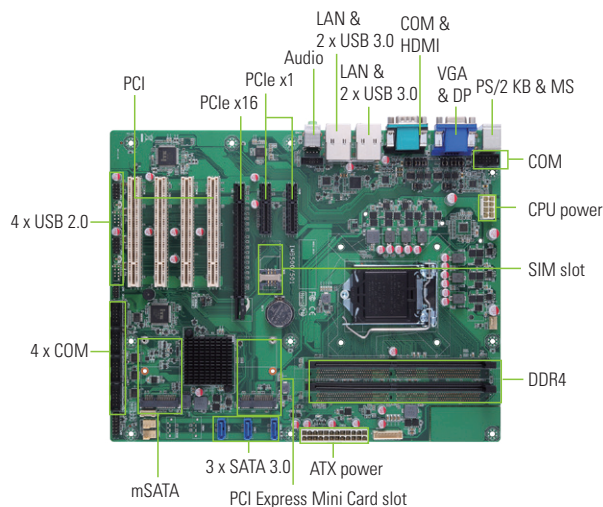

▲ Side view



## Core System

CPU	LGA1151 socket 7th/6th gen Intel® Core™ i7/i5/i3, Pentium® & Celeron® processor
System Memory	2 x 288-pin DDR4-2133/2400 DIMM, up to 32GB
Chipset	Intel® H110
BIOS	AMI BIOS
SSD	N/A
Watchdog Timer	255 levels, 1 to 255 sec.
Expansion Interface	1 x PCIe x16 slot 2 x PCIe x4 slot (only support x1 signal) 4 x PCI slot 1 x PCI Express Mini Card slot 1 x SIM slot
Battery	Lithium 3 V/220 mAH
Dimensions	305 x 244 mm
Board Thickness	1.6 mm
Operating Temperature	0°C to +60°C (+32°F to +140°F)
Humidity	10% to 95% relative humidity, non-condensing

## I/O

SATA	3 x SATA-600 1 x mSATA
Hardware Monitoring	Detect CPU/system temperature, voltage and supports Smart fan control
Ethernet	1x 10/100/1000 Mbps Ethernet with Intel® i219-LM; supports Wake-on-LAN, PXE Boot ROM 1 x 10/100/1000 Mbps Ethernet with Intel® i210-AT; supports Wake-on-LAN, PXE Boot ROM
Audio	HD Codec audio as Mic-in/Line-in/Line-out with Realtek ALC662
USB	4 x USB 3.0 4 x USB 2.0
Serial	4 x RS-232 (Internal box header) 2 x RS-232/422/485 (COM 1: rear IO, COM 2: internal box header)
PS/2 Combo Port	1 x PS/2 keyboard and mouse
TPM	N/A
SMBus	Yes
Digital I/O	8-channel programmable

## Display

Graphic	Intel® HD Graphic
Memory Size	Share system memory
Display Interface	1 x DisplayPort 1 x HDMI 1 x VGA

## Ordering Information

### Standard

IMB501 (P/N: E38M501101)	ATX motherboard with LGA1151 socket 7th/6th gen Intel® Core™ i7/i5/i3, Pentium® & Celeron® processor, Intel® H110, USB 3.0, SATA 3.0, 2 GbE LANs, VGA, DisplayPort, HDMI and mSATA
-----------------------------	--

### Optional

5938A808010E	2 x USB 2.0 cable with bracket, P=2.54 mm, L=190 mm
5938A808020E	2 x USB 2.0 cable with bracket, P=2.54 mm, L=400 mm
593826A0000E	SATA signal cable/red, L=500 mm
59384500100E	Audio cable with bracket, P=2.0 mm, L=450 mm
59380402010E	1 x COM port cable with bracket, P=2.54 mm, L=300 mm
59380703000E	2 x COM port cable with bracket, P=2.54 mm, L=300 mm

# IMB502

ATX Motherboard with LGA1151 Socket 7th/6th Gen Intel® Core™ Processor, Intel® Q170, USB 3.0, SATA 3.0, Dual LANs, VGA, DVI-D and HDMI

## Features

- LGA1151 socket 7th/6th gen Intel® Core™ i7/i5/i3, Pentium® & Celeron® processor (Kaby Lake/Skylake)
- Four 288-pin DDR4-2133/2400 DIMM for up to 64GB of memory
- VGA, DVI-D and HDMI with triple-view supported
- 5 SATA-600 with RAID 0/1/5/10
- 6 USB 3.0 and 7 USB 2.0

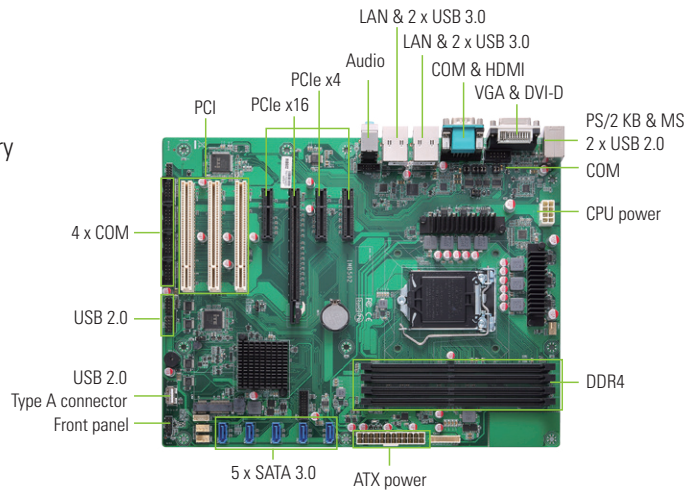

## Core System

CPU	LGA1151 socket 7th/6th gen Intel® Core™ i7/i5/i3, Pentium® & Celeron® processor
System Memory	4 x 288-pin DDR4-2133/2400 DIMM, up to 64GB
Chipset	Intel® Q170
BIOS	AMI BIOS
SSD	N/A
Watchdog Timer	255 levels, 1 to 255 sec.
Expansion Interface	1 x PCIe x16 slot 3 x PCIe x4 slot 3 x PCI slot
Battery	Lithium 3 V/ 220 mAh
Dimensions	305 x 244 mm
Board Thickness	1.6 mm
Operating Temperature	0°C to +60°C (+32°F to +140°F)
Humidity	10% to 95% relative humidity, non-condensing

## I/O

SATA	5 x SATA-600 with RAID 0/1/5/10
Hardware Monitoring	Detect CPU/system temperature, voltage and supports Smart fan control
Ethernet	1 x 10/100/1000 Mbps Ethernet with Intel® i219-LM; supports Wake-on-LAN, PXE Boot ROM, iAMT 1 x 10/100/1000 Mbps Ethernet with Intel® i211-AT; supports Wake-on-LAN, PXE Boot ROM
Audio	HD Codec audio as MIC-in/Line-in/Line-out with Realtek ALC662
USB	6 x USB 3.0 (4 ports on rear I/O; 2 ports on internal box header) 7 x USB 2.0 (2 ports on rear I/O; 4 ports on internal pin-header; 1 port USB Type A connector onboard)
Serial	5 x RS-232 (Internal box header) 1 x RS-232/422/485 (COM 1: rear)
PS/2 Combo Port	1 x PS/2 keyboard and mouse
TPM	N/A
SMBus	Yes
Digital I/O	8 channels programmable

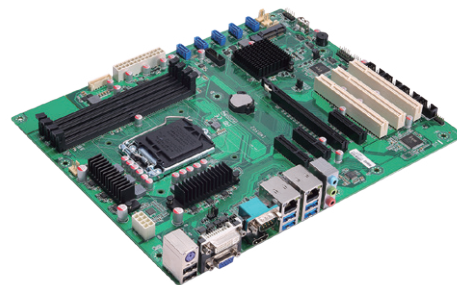

▲ Side view

## Display

Graphic	Intel® HD Graphic
Memory Size	Share system memory
Display Interface	1 x VGA 1 x DVI-D 1 x HDMI

## Ordering Information

Standard	
IMB502 (P/N: E38F502101)	ATX motherboard with LGA1151 socket 7th/6th gen Intel® Core™ i7/i5/i3, Pentium® & Celeron® processor, Intel® Q170, USB 3.0, SATA 3.0, 2 GbE LANs, VGA, DVI-D, and HDMI

Optional	
5938A808010E	2 x USB 2.0 cable with bracket, P=2.54 mm, L=190 mm
5938A808020E	2 x USB 2.0 cable with bracket, P=2.54 mm, L=400 mm
5948C122800E	2 x USB 3.1 Gen1 cable with bracket, L=400 mm
593826A0000E	SATA signal cable/red, L=500 mm
59384500100E	Audio cable with bracket, P=2.0 mm, L=450 mm
59380402010E	1 x COM port cable with bracket, P=2.54 mm, L=300 mm
59380703000E	2 x COM port cable with bracket, P=2.54 mm, L=300 mm





# IMB520 NEW

ATX Motherboard with LGA1151 Socket 8th Gen Intel® Core™ Processor, Intel® Q370, USB 3.1 Gen2, SATA 3.0, Dual LANs, VGA, DP, DVI-D, and HDMI

## Features

- LGA1151 socket 8th gen Intel® Core™ i7/i5/i3, Pentium® & Celeron® processor (Coffee Lake)
- Four 288-pin DDR4-2666/2400 DIMM for up to 64GB of memory
- VGA, DisplayPort, DVI-D and HDMI with triple-view supported
- 4 SATA-600 with RAID 0/1/5/10
- Two USB 3.1 Gen2 and four USB 3.1 Gen1
- TPM 2.0 supported (optional)

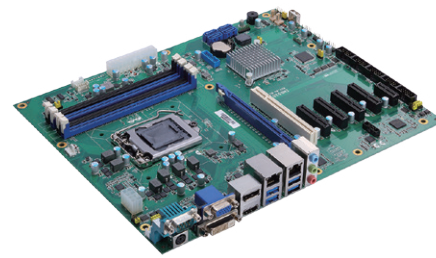
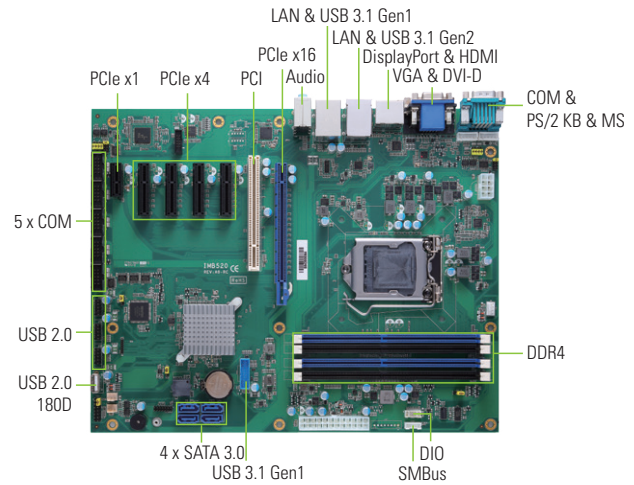

▲ Side view



## Core System

CPU	LGA1151 socket 8th gen Intel® Core™ i7/i5/i3, Pentium® & Celeron® processor
System Memory	4 x 288-pin DDR4-2666/2400 DIMM, up to 64GB
Chipset	Intel® Q370
BIOS	AMI BIOS
SSD	N/A
Watchdog Timer	255 levels, 1 to 255 sec.
Expansion Interface	1 x PCIe x16 slot 4 x PCIe x4 slot 1 x PCIe x1 slot 1 x PCI
Battery	Lithium 3 V/ 220 mA
Dimensions	305 x 244 mm
Board Thickness	1.6 mm
Operating Temperature	0°C to +60°C (+32°F to +140°F)
Humidity	10% to 95% relative humidity, non-condensing

## I/O

SATA	4 x SATA-600 with RAID 0/1/5/10
Hardware Monitoring	Detect CPU/system temperature, voltage and supports Smart fan control
Ethernet	1x 10/100/1000 Mbps Ethernet with Intel® i219-LM; supports Wake-on-LAN, PXE Boot ROM, iAMT 1 x 10/100/1000 Mbps Ethernet with Intel® i211-AT; supports Wake-on-LAN, PXE Boot ROM
Audio	HD Codec audio as MIC-in/Line-in/Line-out with Realtek ALC662
USB	2 x USB 3.1 Gen2 (rear I/O) 4 x USB 3.1 Gen1 (rear I/O, internal box header) 7 x USB 2.0 (pin header, 180D type A)
Serial	4 x RS-232 (Internal box header) 2 x RS-232/422/485 (COM 1: rear, COM 2: internal box header)
PS/2 Combo Port	1 x PS/2 keyboard and mouse
TPM	TPM 2.0 (optional)
SMBus	Yes
Digital I/O	8-channel programmable

## Display

Graphic	Intel® HD Graphic
Memory Size	Share system memory
Display Interface	1 x VGA 1 x DVI-D 1 x HDMI 1 x DisplayPort

## Ordering Information

Standard	
IMB520	ATX motherboard with LGA1151 socket 8th gen Intel® Core™ i7/i5/i3, Pentium® & Celeron® processor, Intel® Q370, USB 3.1 Gen2, SATA 3.0, 2 GbE LANs, VGA, DP, DVI-D, and HDMI
Optional	
5938A808010E	2 x USB 2.0 cable with bracket, P=2.54 mm, L=190 mm
5938A808020E	2 x USB 2.0 cable with bracket, P=2.54 mm, L=400 mm
5948C122800E	2 x USB 3.1 Gen1 cable with bracket, L=400 mm
59380000290E	PS/2 keyboard & mouse cable with bracket
593826A0000E	SATA signal cable/red, L=500 mm
59384500100E	Audio cable with bracket, P=2.0 mm, L=450 mm
59380402010E	1 x COM port cable with bracket, P=2.54 mm, L=300 mm
59380703000E	2 x COM port cable with bracket, P=2.54 mm, L=300 mm
83935151000E	TPM 2.0 module (AX93515)

# IMB521 NEW

ATX Motherboard with LGA1151 Socket 8th Gen Intel® Core™ Processor, Intel® C246, ECC DDR4, USB 3.0, SATA 3.0, Dual LANs, VGA, DP, DVI-D, and HDMI

## Features

- LGA1151 socket 8th gen Intel® Core™ i7/i5/i3, Pentium® & Celeron® processor (Coffee Lake)
- Four 288-pin DDR4-2133/2400 ECC DIMM for up to 64GB of memory
- DisplayPort, VGA, DVI-D and HDMI with triple-view supported
- 4 SATA-600 with RAID 0/1/5/10
- Two USB 3.1 Gen2 and four USB 3.1 Gen1
- TPM 2.0 supported (optional)



### Core System

CPU	LGA1151 socket 8th gen Intel® Core™ i7/i5/i3, Pentium® & Celeron® processor
System Memory	4 x 288-pin DDR4-2133/2400 ECC DIMM, up to 64GB
Chipset	Intel® C246
BIOS	AMI BIOS
SSD	N/A
Watchdog Timer	255 levels, 1 to 255 sec.
Expansion Interface	1 x PCIe x16 slot 4 x PCIe x4 slot 1 x PCIe x1 slot 1 x PCI
Battery	Lithium 3 V/ 220 mAh
Dimensions	305 x 244 mm
Board Thickness	1.6 mm
Operating Temperature	0°C to +60°C (+32°F to +140°F)
Humidity	10% to 95% relative humidity, non-condensing

### I/O

SATA	4 x SATA-600 with RAID 0/1/5/10
Hardware Monitoring	Detect CPU/system temperature, voltage and supports Smart fan control
Ethernet	1 x 10/100/1000 Mbps Ethernet with Intel® i219-LM; supports Wake-on-LAN, PXE Boot ROM, iAMT 1 x 10/100/1000 Mbps Ethernet with Intel® i211-AT; supports Wake-on-LAN, PXE Boot ROM
Audio	HD Codec audio as MIC-in/Line-in/Line-out with Realtek ALC662
USB	2 x USB 3.1 Gen2 (rear I/O) 4 x USB 3.1 Gen1 (rear I/O, internal box header) 7 x USB 2.0 (pin header, 180D type A)
Serial	4 x RS-232 (Internal box header) 2 x RS-232/422/485 (COM 1: rear, COM 2: internal box header)
PS/2 Combo Port	1 x PS/2 keyboard and mouse
TPM	TPM 2.0 (optional)
SMBus	Yes
Digital I/O	8-channel programmable

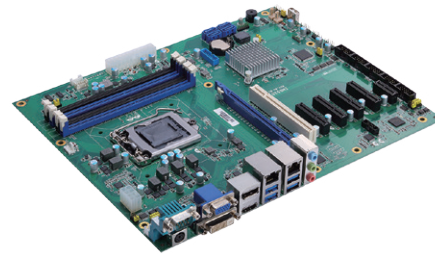
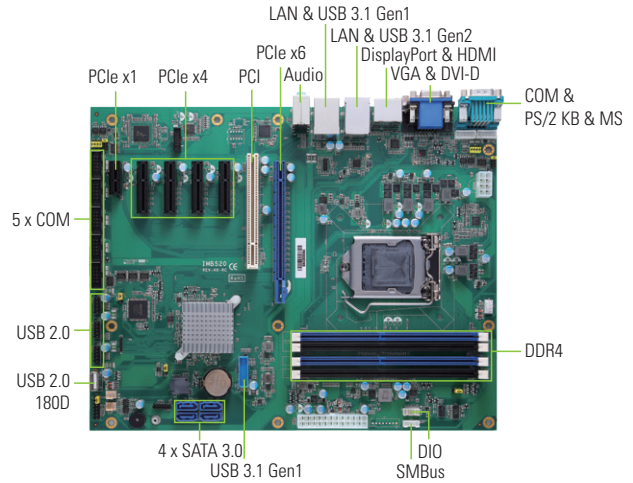

▲ Side view

### Display

Graphic	Intel® HD Graphic
Memory Size	Share system memory
Display Interface	1 x VGA 1 x DVI-D 1 x HDMI 1 x DisplayPort

### Ordering Information

Standard	
IMB521	ATX motherboard with LGA1151 socket 8th gen Intel® Core™ i7/i5/i3, Pentium® & Celeron® processor, Intel® C246, USB 3.1 Gen2, SATA 3.0, 2 GbE LANs, VGA, DP, DVI-D, and HDMI
Optional	
5938A808010E	2 x USB 2.0 cable with bracket, P=2.54 mm, L=190 mm
5938A808020E	2 x USB 2.0 cable with bracket, P=2.54 mm, L=400 mm
5948C122800E	2 x USB 3.1 Gen1 cable with bracket, L=400 mm
59380000290E	PS/2 keyboard & mouse cable with bracket
593826A0000E	SATA signal cable/red, L=500 mm
59384500100E	Audio cable with bracket, P=2.0 mm, L=450 mm
59380402010E	1 x COM port cable with bracket, P=2.54 mm, L=300 mm
59380703000E	2 x COM port cable with bracket, P=2.54 mm, L=300 mm
83935151000E	TPM 2.0 module (AX93515)

# IMB523 NEW

ATX Motherboard with LGA1151 Socket 8th Gen Intel® Core™ Processor, Intel® Q370, USB 3.1 Gen2, SATA 3.0, Dual LANs, VGA, DP, DVI-D, and HDMI

## Features

- LGA1151 socket 8th gen Intel® Core™ i7/i5/i3, Pentium® & Celeron® processor (Coffee Lake)
- Four 288-pin DDR4-2666/2400 DIMM for up to 64GB of memory
- DisplayPort, DVI-D, HDMI and VGA with triple-view supported
- 6 SATA-600 with RAID 0/1/5/10
- Two USB 3.1 Gen2 and four USB 3.1 Gen1
- TPM 2.0 supported (optional)

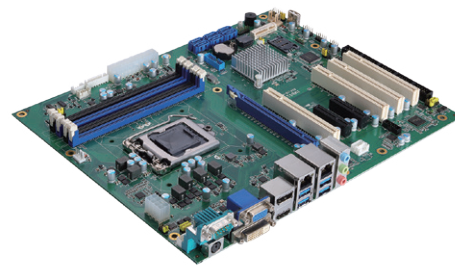
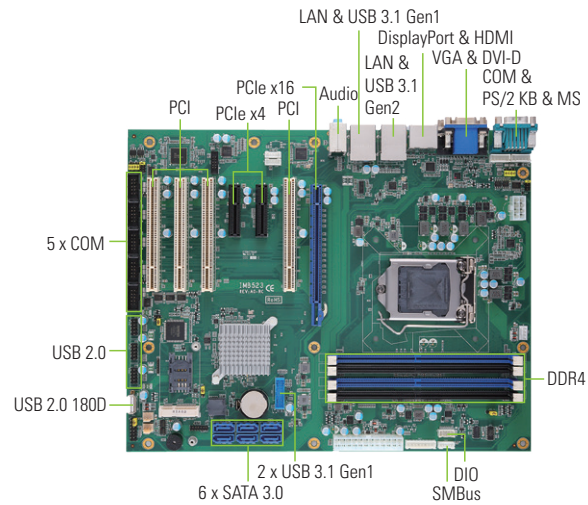

▲ Side view



## Core System

CPU	LGA1151 socket 8th gen Intel® Core™ i7/i5/i3, Pentium® & Celeron® processor
System Memory	4 x 288-pin DDR4-2666/2400 DIMM, up to 64GB
Chipset	Intel® Q370
BIOS	AMI BIOS
SSD	N/A
Watchdog Timer	255 levels, 1 to 255 sec.
Expansion Interface	1 x PCIe x16 slot 2 x PCIe x4 slot 4 x PCI slot
Battery	Lithium 3 V/ 220 mAh
Dimensions	305 x 244 mm
Board Thickness	1.6 mm
Operating Temperature	0°C to +60°C (+32°F to +140°F)
Humidity	10% to 95% relative humidity, non-condensing

## I/O

SATA	6 x SATA-600 with RAID 0/1/5/10
Hardware Monitoring	Detect CPU/system temperature, voltage and supports Smart fan control
Ethernet	1 x 10/100/1000 Mbps Ethernet with Intel® i219-LM; supports Wake-on-LAN, PXE Boot ROM, iAMT 1 x 10/100/1000 Mbps Ethernet with Intel® i211-AT; supports Wake-on-LAN, PXE Boot ROM
Audio	HD Codec audio as MIC-in/Line-in/Line-out with Realtek ALC662
USB	2 x USB 3.1 Gen2 (rear IO) 4 x USB 3.1 Gen1 (rear IO, internal box header) 7 x USB 2.0 (pin header, 180D type A)
Serial	4 x RS-232 (Internal box header) 2 x RS-232/422/485 (COM 1: rear I/O; COM 2: internal box header)
PS/2 Combo Port	1 x PS/2 keyboard and mouse
TPM	TPM 2.0 (optional)
SMBus	Yes
Digital I/O	8-channel programmable

## Display

Graphic	Intel® HD Graphic
Memory Size	Share system memory
Display Interface	1 x VGA 1 x DVI-D 1 x HDMI 1 x DisplayPort

## Ordering Information

Standard	
IMB523	ATX motherboard with LGA1151 socket 8th gen Intel® Core™ i7/i5/i3, Pentium® & Celeron® processor, Intel® Q370, USB 3.1 Gen2, SATA 3.0, 2 GbE LANs, VGA, DP, DVI-D and HDMI
Optional	
5938A808010E	2 x USB 2.0 cable with bracket, P=2.54 mm, L=190 mm
5938A808020E	2 x USB 2.0 cable with bracket, P=2.54 mm, L=400 mm
5948C122800E	2 x USB 3.1 Gen1 cable with bracket, L=400 mm
59380000290E	PS/2 keyboard & mouse cable with bracket
593826A0000E	SATA signal cable/red, L=500 mm
59384500100E	Audio cable with bracket, P=2.0 mm, L=450 mm
59380402010E	1 x COM port cable with bracket, P=2.54 mm, L=300 mm
59380703000E	2 x COM port cable with bracket, P=2.54 mm, L=300 mm
83935151000E	TPM 2.0 module (AX93515)

# IMB524 NEW

ATX Motherboard with LGA1151 Socket 8th Gen Intel® Core™ Processor, Intel® H310, USB 3.1 Gen1, SATA 3.0, Dual LANs, VGA, DP, DVI-D, and HDMI

## Features

- LGA1151 socket 8th gen Intel® Core™ i7/i5/i3, Pentium® & Celeron® processor (Coffee Lake)
- Two 288-pin DDR4-2666/2400 DIMM for up to 32GB of memory
- DisplayPort, DVI-D, HDMI and VGA with dual-view supported
- 4 SATA-600
- 4 USB 3.1 Gen1 and 5 USB 2.0
- TPM 2.0 supported (optional)

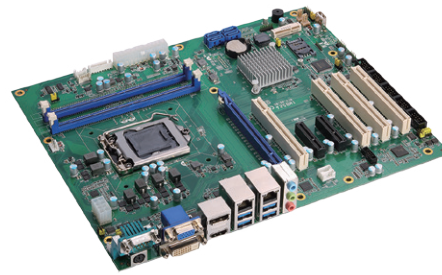
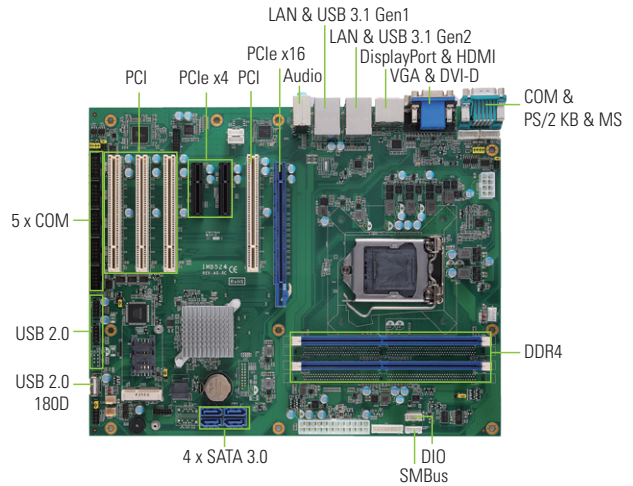

▲ Side view



## Core System

CPU	LGA1151 socket 8th gen Intel® Core™ i7/i5/i3, Pentium® & Celeron® processor
System Memory	2 x 288-pin DDR4-2666/2400 DIMM, up to 32GB
Chipset	Intel® H310
BIOS	AMI BIOS
SSD	N/A
Watchdog Timer	255 levels, 1 to 255 sec.
Expansion Interface	1 x PCIe x16 slot 2 x PCIe x4 slot (2 PCIe x1 signal) 4 x PCI slot
Battery	Lithium 3 V/ 220 mAh
Dimensions	305 x 244 mm
Board Thickness	1.6 mm
Operating Temperature	0°C to +60°C (+32°F to +140°F)
Humidity	10% to 95% relative humidity, non-condensing

## I/O

SATA	4 x SATA-600
Hardware Monitoring	Detect CPU/system temperature, voltage and supports Smart fan control
Ethernet	1 x 10/100/1000 Mbps Ethernet with Intel® i219-LM; supports Wake-on-LAN, PXE Boot ROM 1 x 10/100/1000 Mbps Ethernet with Intel® i211-AT; supports Wake-on-LAN, PXE Boot ROM
Audio	HD Codec audio as MIC-in/Line-in/Line-out with Realtek ALC662
USB	4 x USB 3.1 Gen1 (rear I/O) 5 x USB 2.0 (pin header, 180D type A)
Serial	4 x RS-232 (Internal box header) 2 x RS-232/422/485 (COM 1: rear I/O; COM 2: internal box header)
PS/2 Combo Port	1 x PS/2 keyboard and mouse
TPM	TPM 2.0 (optional)
SMBus	Yes
Digital I/O	8-channel programmable

## Display

Graphic	Intel® HD Graphic
Memory Size	Share system memory
Display Interface	1 x VGA 1 x DVI-D 1 x HDMI 1 x DisplayPort

## Ordering Information

Standard	
IMB524	ATX motherboard with LGA1151 socket 8th gen Intel® Core™ i7/i5/i3, Pentium® & Celeron® processor, Intel® H310, USB 3.1 Gen1, SATA 3.0, 2 GbE LANs, VGA, DP, DVI-D and HDMI

Optional	
5938A808010E	2 x USB 2.0 cable with bracket, P=2.54 mm, L=190 mm
5938A808020E	2 x USB 2.0 cable with bracket, P=2.54 mm, L=400 mm
5948C122800E	2 x USB 3.1 Gen1 cable with bracket, L=400 mm
59380000290E	PS/2 keyboard & mouse cable with bracket
593826A0000E	SATA signal cable/red, L=500 mm
59384500100E	Audio cable with bracket, P=2.0 mm, L=450 mm
59380402010E	1 x COM port cable with bracket, P=2.54 mm, L=300 mm
59380703000E	2 x COM port cable with bracket, P=2.54 mm, L=300 mm
83935151000E	TPM 2.0 module (AX93515)



# IMB525 NEW

ATX Motherboard with LGA1151 Socket 8th Gen Intel® Core™ Processor, Intel® C246, ECC DDR4, USB 3.1 Gen, SATA 3.0, Dual LANs, VGA, DP, DVI-D, and HDMI

## Features

- LGA1151 socket 8th gen Intel® Core™ i7/i5/i3, Pentium® & Celeron® processor (Coffee Lake)
- Four 288-pin DDR4-2666/2400 ECC DIMM for up to 64GB of memory
- DisplayPort DVI-D, HDMI and VGA with triple-view supported
- 6 SATA-600 with RAID 0/1/5/10
- Two USB 3.1 Gen2 and four USB 3.1 Gen1
- TPM 2.0 supported (optional)

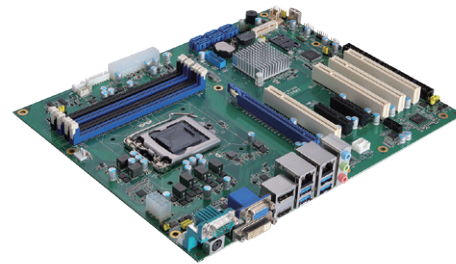
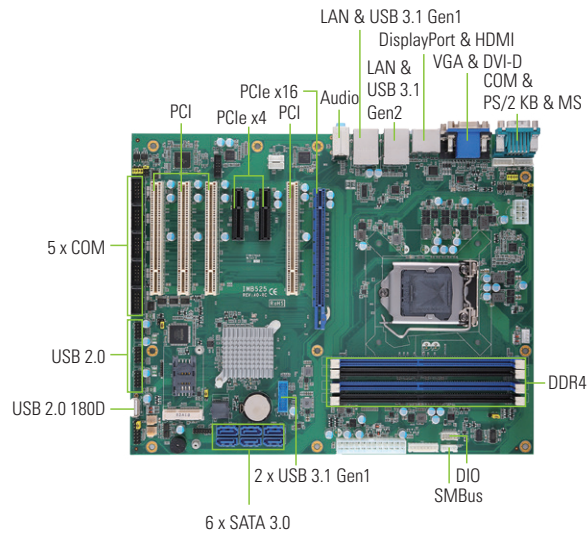

▲ Side view

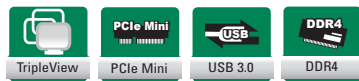

## Core System

CPU	LGA1151 socket 8th gen Intel® Core™ i7/i5/i3, Pentium® & Celeron® processor
System Memory	4 x 288-pin DDR4-2666/2400 ECC DIMM, up to 64GB
Chipset	Intel® C246
BIOS	AMI BIOS
Watchdog Timer	255 levels, 1 to 255 sec.
Expansion Interface	1 x PCIe x16 slot 2 x PCIe x4 slot 4 x PCI slot
Battery	Lithium 3 V/ 220 mAh
Dimensions	305 x 244 mm
Board Thickness	1.6 mm
Operating Temperature	0°C to +60°C (+32°F to +140°F)
Humidity	10% to 95% relative humidity, non-condensing

## I/O

SATA	6 x SATA-600 with RAID 0/1/5/10
Hardware Monitoring	Detect CPU/system temperature, voltage and supports Smart fan control
Ethernet	1x 10/100/1000 Mbps Ethernet with Intel® i219-LM; supports Wake-on-LAN, PXE Boot ROM, iAMT 1 x 10/100/1000 Mbps Ethernet with Intel® i211-AT; supports Wake-on-LAN, PXE Boot ROM
Audio	HD Codec audio as MIC-in/Line-in/Line-out with Realtek ALC662
USB	2 x USB 3.1 Gen2 (rear I/O) 4 x USB 3.1 Gen1 (rear I/O, internal box header) 7 x USB 2.0 (pin header, 180D type A)
Serial	4 x RS-232 (Internal box header) 2 x RS-232/422/485 (COM 1: rear I/O; COM 2: internal box header)
PS/2 Combo Port	1 x PS/2 keyboard and mouse
TPM	TPM 2.0 (optional)
SMBus	Yes
Digital I/O	8-channel programmable

## Display

Graphic	Intel® HD Graphic
Memory Size	Share system memory
Display Interface	1 x VGA 1 x DVI-D 1 x HDMI 1 x DisplayPort

## Ordering Information

### Standard

IMB525	ATX motherboard with LGA1151 socket 8th gen Intel® Core™ i7/i5/i3, Pentium® & Celeron® processor, Intel® C246, USB 3.1 Gen2, SATA 3.0, 2 GbE LANs, VGA, DP, DVI-D, and HDMI
--------	---

### Optional

5938A808010E	2 x USB 2.0 cable with bracket, P=2.54 mm, L=190 mm
5938A808020E	2 x USB 2.0 cable with bracket, P=2.54 mm, L=400 mm
5948C122800E	2 x USB 3.1 Gen1 cable with bracket, L=400 mm
5938000290E	PS/2 keyboard & mouse cable with bracket
593826A0000E	SATA signal cable/red, L=500 mm
59384500100E	Audio cable with bracket, P=2.0 mm, L=450 mm
59380402010E	1 x COM port cable with bracket, P=2.54 mm, L=300 mm
59380703000E	2 x COM port cable with bracket, P=2.54 mm, L=300 mm
83935151000E	TPM 2.0 module (AX93515)



# IMB210

ATX Motherboard with LGA1150 Socket Intel® Xeon® E3-v3 Processor, Intel® C226, ECC DDR3, USB 3.0, SATA 3.0, Dual LANs, DisplayPort, DVI-I, HDMI and CFast™

## Features

- LGA1150 socket Intel® Xeon® E3-v3, Core™ i7/i5/i3, Pentium® & Celeron® (Haswell/Haswell Refresh)
- Intel® C226
- 4 DDR3-1333/1600 ECC DIMM for up to 32GB of memory
- DisplayPort, HDMI and DVI-I with triple-view supported
- PCIe x16 Gen3 supported
- 5 SATA-600 with RAID 0/1/5/10
- 4 USB 3.0 ports
- TPM 1.2 supported
- Intel® AMT 9.0 supported

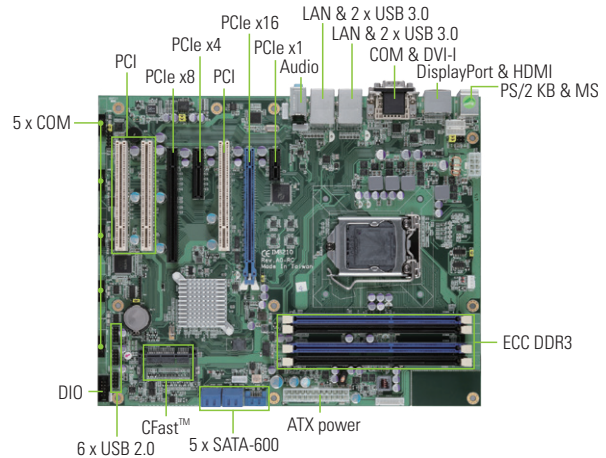

## Core System

CPU	LGA1150 socket 4th gen Intel® Xeon® E3-v3, Core™ i7/i5/i3, Pentium® and Celeron® processor (Haswell/Haswell Refresh)
System Memory	4 x 240-pin DDR3-1333/1600 ECC DIMM, up to 32GB
Chipset	Intel® C226
BIOS	AMI BIOS
SSD	1 x CFast™
Watchdog Timer	255 levels
Expansion Interface	2 x PCIe x16 Gen3 slot (1 PCIe x16 or 2 PCIe x8 when use dual PCIe x8 concurrently ) 1 x PCIe x4 Gen2 1 x PCIe x1 Gen2 3 x PCI
Battery	Lithium 3 V/220 mAH
Power Input	E3-1275V3 3.5 GHz DDR3, 2GB 1333 +5V @ 1.7A, +12V @ 0.55A, +5V SBY @ 0.12A, +3.3V @ 0.73A
Dimensions	305 x 244 mm
Board Thickness	1.6 mm
Operating Temperature	0°C to +60°C (+32°F to +140°F)
Humidity	10% to 95% relative humidity, non-condensing

## I/O

SATA	5 x SATA-600 with RAID 0/1/5/10
Hardware Monitoring	Detect CPU/system temperature, voltage and support Smart fan control
Ethernet	1 x 10/100/1000 Mbps Ethernet with Intel® i217-LM; supports Wake-on-LAN, PXE Boot ROM, iAMT 1 x 10/100/1000 Mbps Ethernet with Intel® i210-AT; supports Wake-on-LAN, PXE Boot ROM
Audio	HD Codec audio as MIC-in/Line-in/Line-out with Realtek ALC662 2 x speaker-out with 1W/8ohm
USB	4 x USB 3.0 6 x USB 2.0
Serial	5 x RS-232 (Internal box header) 1 x RS-232/422/485 (Rear I/O)
PS/2 Combo Port	1 x PS/2 keyboard and mouse
TPM	TPM 1.2
SMBus	Yes
Digital I/O	8-channel (4-in & 4-out)

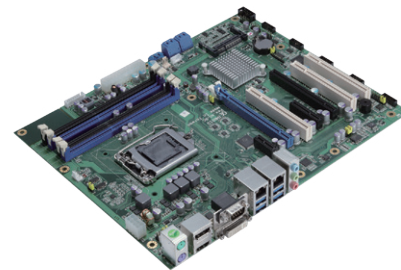

▲ Side view

## Display

Display Chipset	Intel® HD Integrated Graphics
Memory Size	Max. up to 1.7GB
Display Interface	1 x DisplayPort 1 x HDMI 1 x DVI-I

## Packing List

User's manual/utility CD, cable

## Ordering Information

Standard	
IMB210 (P/N: E38F210100)	ATX motherboard with LGA1150 socket Intel® Xeon® E3-v3, Core™ i7/i5/i3, Pentium® & Celeron® (Haswell/Haswell Refresh), ECC DDR3, USB 3.0, SATA3.0, 2 GbE LANs, DisplayPort, DVI-I, HDMI and CFast™



# IMB211

ATX Motherboard with LGA1150 Socket 4th Gen Intel® Core™ Processor, Intel® Q87, USB 3.0, SATA 3.0, Dual LANs, DisplayPort, VGA, HDMI and mSATA

## Features

- LGA1150 socket 4th gen Intel® Core™ i7/i5/i3 and Celeron® processor (Haswell)
- 4 DDR3-1333/1600 DIMM for up to 32GB of memory
- DisplayPort, HDMI and VGA with triple-view supported
- PCIe x16 Gen3 supported
- 5 SATA-600 with RAID 0/1/5/10
- 4 USB 3.0 ports
- Intel® AMT 9.0 supported

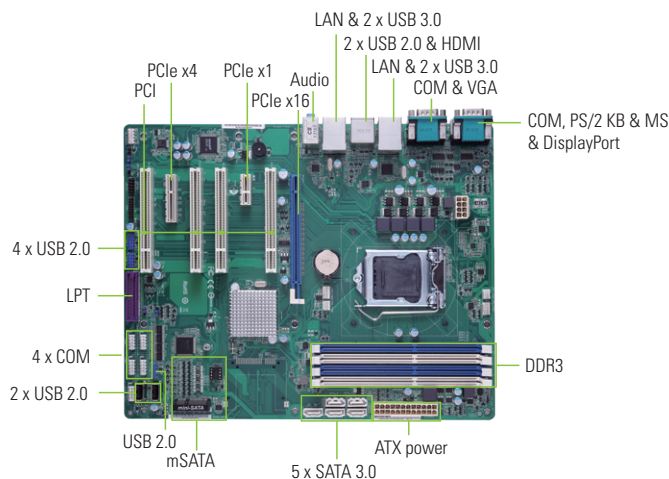

## Core System

CPU	LGA1150 socket 4th generation Intel® Core™ i7/i5/i3 & Celeron® processor (Haswell)
System Memory	4 x 240-pin DDR3-1333/1600 DIMM, up to 32GB
Chipset	Intel® Q87
BIOS	AMI UEFI BIOS whit OA 3.0 built
SSD	N/A
Watchdog Timer	255 levels, 1 to 255 sec.
Expansion Interface	1 x PCIe x16 Gen3 slots 1 x PCIe x4 Gen2 1 x PCIe x1 Gen2 4 x PCI
Battery	Lithium 3 V/220 mAh
Power Requirements	i7-4770S 3.1 GHz 8GB x 4 DDR3-1600, +12V @ 5.3A, -12V @ 0.1A, +5V @ 2.7A, +5VSB @ 0.2A, +3.3V @ 0.8A
Dimensions	305 x 244 mm
Board Thickness	1.6 mm
Operating Temperature	0°C to +60°C (32°F to 140°F)
Humidity	10% to 95% relative humidity, non-condensing

## I/O

SATA	5 x SATA-600 with RAID 0/1/5/10 1 x mSATA
Hardware Monitoring	Detect CPU/system temperature, voltage and support Smart Fan Control
Ethernet	1 x 10/100/1000 Mbps Ethernet with Intel® i217-LM; supports Wake-on-LAN, PXE Boot ROM, iAMT 1 x 10/100/1000 Mbps Ethernet with Intel® i210-LM; supports Wake-on-LAN, PXE Boot ROM
Audio	HD Codec audio as MIC-in/Line-in/Line-out
USB	4 x USB 3.0 10 x USB 2.0 (2 in rear I/O, 6 with pin header and 2 vertical type connectors)
Serial	4 x RS-232 (internal box header) 2 x RS-232/422/485 (rear I/O) 1 x LPT header
PS/2 Combo Port	1x PS/2 keyboard & mouse
TPM	N/A
SMBus	N/A
Digital I/O	8-channel programmable

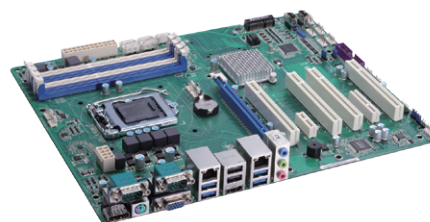

▲ Side view

## Display

Display Chipset	Intel® HD Integrated graphics
Memory Size	TBD
Display Interface	1 x DisplayPort 1 x HDMI 1 x VGA

## Packing List

I/O Bracket

## Ordering Information

Standard	
IMB211 (P/N: E38F211101)	ATX motherboard with LGA1150 socket Intel® Core™ i7/i5/i3 & Celeron® USB 3.0, SATA 3.0, 2 GbE LANs, DisplayPort, VGA, HDMI and mSATA
Optional	
5938A808010E	2 x USB 2.0 cable with bracket, P=2.54 mm, L=190 mm
5938A808020E	2 x USB 2.0 cable with bracket, P=2.54 mm, L=400 mm
593826A0000E	SATA signal cable/red, L=500 mm
59380402010E	1 x COM port cable with bracket, P=2.54 mm, L=300 mm
59380703000E	2 x COM port cable with bracket, P=2.54 mm, L=300 mm
593F2040300E	LPT cable with bracket, P=2.54 mm, L=300 mm

# MMB501 NEW

Micro ATX Motherboard with LGA1151 Socket 7th/6th Gen Intel® Core™ Processor, Intel® Q170, USB 3.0, SATA 3.0, Dual LANs VGA, DP, DVI-D, and HDMI

## Features

- LGA1151 socket 7th/6th gen Intel® Core™ i7/i5/i3, Pentium® & Celeron® processor (Kaby Lake/Skylake)
- Four 288-pin DDR4-2133/2400 DIMM for up to 64GB of memory
- DisplayPort, VGA, DVI-D and HDMI with triple-view supported
- 6 SATA-600 with RAID 0/1/5/10
- 6 USB 3.0 and 5 USB 2.0

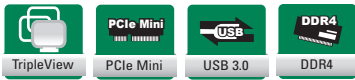
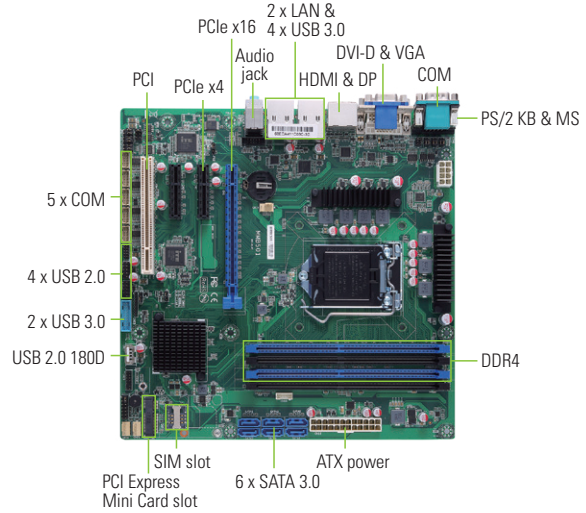

## Core System

CPU	LGA1151 socket 7th/6th gen Intel® Core™ i7/i5/i3, Pentium® & Celeron® processor
System Memory	4 x 288-pin DDR4-2133/2400 DIMM, up to 64GB
Chipset	Intel® Q170
BIOS	AMI BIOS
SSD	N/A
Watchdog Timer	255 levels, 1 to 255 sec.
Expansion Interface	1 x PCIe x16 slot 2 x PCIe x4 slot 1 x PCI slot 1 x Full-size PCI Express Mini Card with SIM slot
Battery	Lithium 3 V/ 220 mAh
Dimensions	244 x 244 mm
Board Thickness	1.6 mm
Operating Temperature	0°C to +60°C (+32°F to +140°F)
Humidity	10% to 95% relative humidity, non-condensing

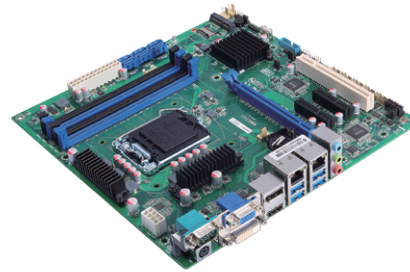

▲ Side view

## Display

Graphic	Intel® HD Graphic
Memory Size	Share system memory
Display Interface	1 x VGA 1 x DVI-D 1 x HDMI 1 x DisplayPort

## I/O

SATA	6 x SATA-600 with RAID 0/1/5/10
Hardware Monitoring	Detect CPU/system temperature, voltage and supports Smart fan control
Ethernet	1 x 10/100/1000 Mbps Ethernet with Intel® i219LM; supports Wake-on-LAN, PXE Boot ROM, iAMT 1 x 10/100/1000 Mbps Ethernet with Intel® i211-AT; supports Wake-on-LAN, PXE Boot ROM
Audio	HD Codec audio as MIC-in/Line-in/Line-out with Realtek ALC662
USB	6 x USB 3.0 (4 ports on rear I/O; 2 internal box headers) 5 x USB 2.0 (4-port form internal pin header; 1 USB 180D Type A)
Serial	4 x RS-232 (Internal 2.0 pitch wafer) 1 x RS-232/422/485 (rear I/O) 1 x RS-232/422/485 (Internal 2.0 pitch wafer)
PS/2 Combo Port	1 x PS/2 keyboard and mouse
TPM	TPM 2.0 (optional)
SMBus	Yes
Digital I/O	8-channel programmable

## Ordering Information

Standard	
MMB501 (P/N: E38W501101)	Micro ATX motherboard with LGA1151 socket 7th/6th gen Intel® Core™ i7/i5/i3, Pentium® & Celeron® processor, Intel® Q170, USB 3.0, SATA 3.0, 2 GbE LANs, VGA, DP, DVI-D, and HDMI

Optional	
5938A808010E	2 x USB 2.0 cable with bracket, P=2.54 mm, L=190 mm
5938A808020E	2 x USB 2.0 cable with bracket, P=2.54 mm, L=400 mm
5948C122800E	2 x USB 3.1 Gen1 cable with bracket, L=400 mm
59380000290E	PS/2 keyboard & mouse cable with bracket
593826A0000E	SATA signal cable/red, L=500 mm
59384500100E	Audio cable with bracket, P=2.0 mm, L=450 mm
59382620000E	1 x COM port cable with bracket, P=2.0 mm, L=300 mm
59384500200E	2 x COM port cable with bracket, P=2.0 mm, L=280 mm
893935151000E	TPM 2.0 module (AX93515)

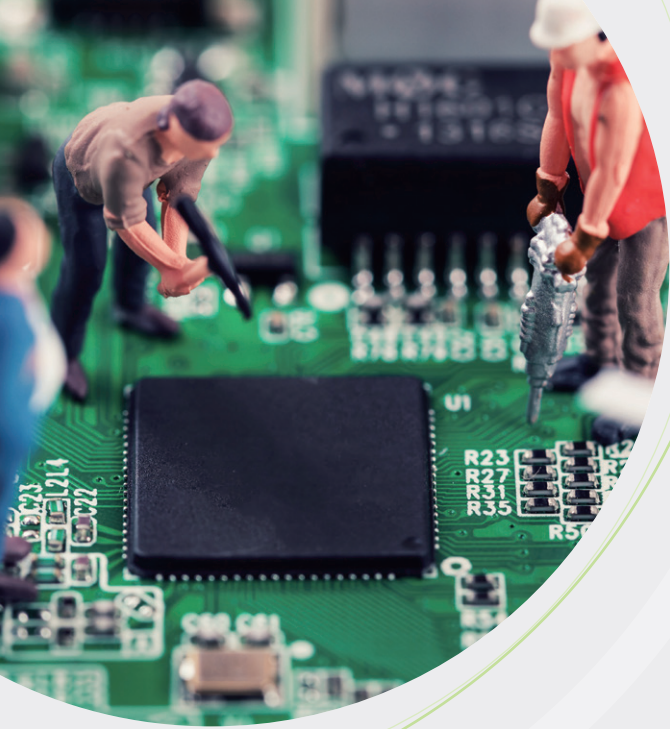

System on Modules

3.5" Embedded Boards

Pico-ITX SBCs

Mini-ITX Motherboards

ATX/Mirco ATX Motherboards

Slot CPU Cards

Smart Display Module

PCI Express Cards

# Boards and Modules

# 6

## Slot CPU Cards

The Slot CPU card family is featured by Intel® Core™ processors. The PICMG 1.3 full-size CPU card is ideal for performance-demanding and bandwidth-concerned applications.

Selection Guide		91
SHB130	PICMG 1.3 Full-size CPU Card with LGA1150 4th Gen Intel® Core™ i7/i5/i3 Processor, Intel® Q87, SATA3, USB 3.0, DVI-D, VGA, DisplayPort and Dual LANs	93
SHB131	PICMG 1.3 Full-size CPU Card with 4th Gen Intel® Core™ i7/i5 & Celeron® U-series Processor, SATA3, USB 3.0, Dual LANs and Dual DVI-D	94
SHB140	PICMG 1.3 Full-size CPU Card with LGA1151 7th/6th Gen Intel® Core™ Processor, Intel® Q170/H110, SATA3, USB 3.0, Dual LANs and DVI-I	95
 SHB150	PICMG 1.3 Full-size CPU Card with LGA1151 8th Gen Intel® Core™ Processor, Intel® C246/Q370/H310, SATA3, USB 3.1 Gen1/Gen2, Dual LANs and DVI-I	96



# PICMG 1.3 Full-size CPU Cards

## Selection Guide



Features/Models	SHB130	SHB131	SHB140
<b>Form Factor</b>	PICMG 1.3	PICMG 1.3	PICMG 1.3
<b>CPU Level</b>	4th Gen Intel® Core™ i7/i5 & Celeron®	4th Gen Intel® Core™ i7/i5 & Celeron®	7th/6th gen Intel® Core™ i7/i5/i3
<b>CPU Socket</b>	LGA1150	BGA1168	LGA1151
<b>CPU FSB Frequency</b>	N/A	N/A	N/A
<b>Core Logic Chipset</b>	Intel® Q87	SoC	Intel® Q170/ H110
<b>Memory Type</b>	DDR3-1333/1600	DDR3L-1600	DDR4-2133
<b>Max. DRAM Capacity</b>	16GB	16GB	32GB
<b>Cache RAM Capacity</b>	Intergrated in CPU	Intergrated in CPU	Intergrated in CPU
<b>BIOS</b>	AMI UEFI BIOS with OA 3.0 built	AMI	AMI UEFI BIOS with OA 3.0 built
<b>Watchdog Timer</b>	255 levels, 1 to 255 sec.	255 levels, 1 to 255 sec.	255 levels, 1 to 255 sec.
<b>SSD</b>	N/A	N/A	N/A
<b>Digital I/O</b>	N/A	N/A	N/A
<b>I/O</b>			
<b>IDE</b>	N/A	N/A	N/A
<b>SATA</b>	6 x SATA-600	2 x SATA-600	6 x SATA-600
<b>FDD</b>	N/A	N/A	N/A
<b>LPT</b>	1 x LPT	1 x LPT	N/A
<b>Serial</b>			
<b>COM 1</b>	RS-232/422/485	RS-232	RS-232/422/485
<b>COM 2</b>	RS-232	RS-232	RS-232
<b>COM 3</b>	RS-232	N/A	RS-232
<b>COM 4</b>	RS-232	N/A	RS-232
<b>COM 5</b>	RS-232	N/A	RS-232
<b>USB</b>	10 x USB 2.0, 4 x USB 3.0	6 x USB 2.0, 2 x USB 3.0	10 x USB 2.0, 2 x USB 3.0
<b>IrDA</b>	N/A	N/A	N/A
<b>IEEE 1394a</b>	N/A	N/A	N/A
<b>Display</b>	1 x VGA or DisplayPort 1 x DVI-D	2 x DVI-D	1 x DVI-I
<b>Ethernet</b>	2 x 10/100/1000 Mbps Ethernet	2 x 10/100/1000 Mbps Ethernet	2 x 10/100/1000 Mbps Ethernet
<b>Audio</b>	HD Codec	HD Codec	HD Codec
<b>Hardware Monitoring</b>	Yes	Yes	Yes
<b>SMBus</b>	Yes	N/A	Yes
<b>Expansion Interface</b>	1 x PCIe x16 1 x PCIe x4 or 4 x PCIe x1 4 x PCI	1 x PCIe x4 or 4 x PCIe x1	1 x PCIe x16 1 x PCIe x4 or 4 x PCIe x1 4 x PCI
<b>Power Management</b>	ACPI	ACPI	ACPI
<b>Battery</b>	Lithium	Lithium	Lithium
<b>Operating Temperature</b>	0°C to +60°C (+32°F to +140°F)	0°C to +60°C (+32°F to +140°F)	0°C to +60°C (+32°F to +140°F)
<b>Relative Humidity</b>	10% to 95%, non-condensing	10% to 95%, non-condensing	10% to 95%, non-condensing
<b>EMI Compliance</b>	CE	UL, CE, FCC	CE

NEW



Features/Models		SHB150
<b>Form Factor</b>		PICMG 1.3
<b>CPU Level</b>		8th gen Intel® Core™
<b>CPU Socket</b>		LGA1151
<b>CPU FSB Frequency</b>		N/A
<b>Core Logic Chipset</b>		Intel® C246/Q370/H310
<b>Memory Type</b>		DDR4-2400
<b>Max. DRAM Capacity</b>		32GB
<b>Cache RAM Capacity</b>		Intergrated in CPU
<b>BIOS</b>		AMI UEFI BIOS with OA 3.0 built
<b>Watchdog Timer</b>		255 levels, 1 to 255 sec.
<b>SSD</b>		N/A
<b>Digital I/O</b>		N/A
	<b>IDE</b>	N/A
	<b>SATA</b>	Q370: 6 x SATA-600, support RAID 0/1/5/10 H310: 4 x SATA-600
	<b>FDD</b>	N/A
	<b>LPT</b>	Yes
<b>I/O</b>	<b>Serial</b>	
	<b>COM 1</b>	RS-232/422/485
	<b>COM 2</b>	RS-232/422/485
	<b>COM 3</b>	RS-232
	<b>COM 4</b>	RS-232
	<b>COM 5</b>	N/A
	<b>USB</b>	Q370: 2 x USB 3.1 Gen2, 4 x USB 3.1 Gen1, 6 x USB 2.0 H310: 4 x USB 3.1 Gen1, 6 x USB 2.0
	<b>IrDA</b>	N/A
<b>IEEE 1394a</b>		N/A
<b>Display</b>		1 x DVI-I
<b>Ethernet</b>		2 x 10/100/1000 Mbps Ethernet
<b>Audio</b>		HD Codec
<b>Hardware Monitoring</b>		Yes
<b>SMBus</b>		Yes
<b>Expansion Interface</b>		1 x PCIe x16 1 x PCIe x4 or 4 x PCIe x1 4 x PCI
<b>Power Management</b>		ACPI
<b>Battery</b>		Lithium
<b>Operating Temperature</b>		0°C to +60°C (+32°F to +140°F)
<b>Relative Humidity</b>		10% to 95%, non-condensing
<b>EMI Compliance</b>		CE

Slot CPU  
Cards

1

2

3

4

5

6

7

8

# SHB130

PICMG 1.3 Full-size CPU Card with LGA1150 4th Gen Intel® Core™ i7/i5/i3 Processor, Intel® Q87, SATA3, USB 3.0, DVI-D, VGA, DisplayPort and Dual LANs

## Features

- LGA1150 socket 4th gen Intel® Core™ i7/i5/i3 processor (Haswell/Haswell Refresh)
- Intel® Q87 chipset
- 2 DDR3-1333/1600 DIMM for up to 16GB of memory
- Intel® AMT 9.0 & TPM supported (optional)
- PCIe Gen3 at 8GT/s supported
- DVI-D, VGA, DisplayPort (optional) with dual-view supported
- 6 SATA-600 with RAID 0/1/5/10
- USB 3.0 supported

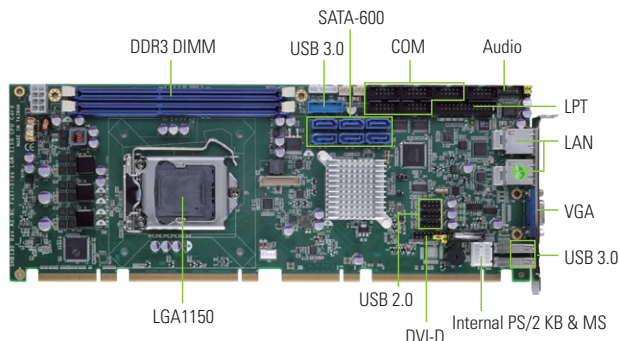

## Core System

CPU	LGA1150 socket 4th gen Intel® Core™ i7/i5/i3 processor (Haswell/Haswell Refresh), TDP up to 65W
System Memory	2 x 240-pin DDR3-1333/1600 DIMM, up to 16GB
Chipset	Intel® Q87
BIOS	AMI UEFI BIOS with OA 3.0 built
SSD	N/A
Watchdog Timer	225 levels, 1 to 255 sec.
Expansion Interface	Edge Connector A: 1 x PCIe x16 Gen3 Edge Connector B: 1 x PCIe x4 or 4 x PCIe x1 Gen2 4 x 32-bit PCI bus masters
Battery	Lithium 3V/220 mAH
Power Requirements	Intel® Core™ i7-4770S +5V @ 2.26A, +12V @ 4.68A, +5VSB @ 0.2A, +3.3V @ 2.3A
Dimensions	338 x 126 mm
Board Thickness	1.6 mm
Operating Temperature	0°C to +60°C (32°F to 140°F)
Humidity	10% to 95% relative humidity, non-condensing

## I/O

SATA	6 x SATA-600; support RAID 0/1/5/10
Hardware Monitoring	Detect CPU/system temperature, voltage and fan speed
Ethernet	1 x 10/100/1000 Mbps Ethernet with Intel® i217-LM; supports Wake-on-LAN, RPL/PXE Boot ROM, AMT 9.0 1 x 10/100/1000 Mbps Ethernet with Intel® i210-AT; supports Wake-on-LAN, RPL/PXE Boot ROM
Audio	HD Codec audio as Mic-in/Line-in/Line-out/Speaker-out with ALC662
USB	10 x USB 2.0 4 x USB 3.0
Serial	4 x RS-232 1 x RS-232/422/485, mode selection by SW
PS/2 Combo Port	1 x PS/2 keyboard & mouse
TPM	Infineon SLB9635 for trusted platform(optional)
SMBus	N/A
Others	1 x LPT with SPP/EPP/ECP supported 2 x Smart fan for system Fan1/Fan2 1 x DIO (4-in & 4-out)

## Display

Chipset	Intel® HD Graphics
Memory Size	Intel® DVM T 5.0
Display Interface	1 x VGA (default) 1 x DVI-D (header) 1 x DisplayPort (optional)

## Packing List

### Standard

Quick installation guide, user's manual/utility CD, cable

### Cable

Part Number	Description	Qty
59380502000E	COM+print cable w/bracket	1
593826A0000E	SATA signal cable, 500 mm	1

## Ordering Information

### Standard

SHB130VGGGA (P/N: E38C130101)	PICMG1.3 full-size CPU card with LGA1150 socket, Intel® Q87, VGA, DVI-D, 2 GbE LANs, audio and PCIe x4
SHB130PGGA (P/N: E38C130105)	PICMG1.3 full-size CPU card with LGA1150 socket, Intel® Q87, DisplayPort, DVI-D, 2 GbE LANs, audio and PCIe x1
SHB130VGGGA (P/N: E38C130102)	PICMG1.3 full-size CPU card with LGA1150 socket, Intel® Q87, VGA, DVI-D, 2 GbE LANs, audio and PCIe x1

### Optional

5938A808010E	2 x USB 2.0 cable with bracket, P=2.54 mm, L=190 mm
5948C122800E	2 x USB 3.1 (Gen1) cable with bracket, L=400 mm
59380000290E	PS/2 keyboard & mouse cable with bracket
593826A0000E	SATA signal cable/red, L=500mm
59384500100E	Audio cable with bracket, P=2.0 mm, L=450 mm
59380402010E	1 x COM port cable with bracket, P=2.54 mm, L=300 mm
59380703000E	2 x COM port cable with bracket, P=2.54 mm, L=300 mm
594C1093500E	DVI cable 24-pin header to DVI-D, L=30 mm
71193221200E	DVI bracket

# SHB131

PICMG 1.3 Full-size CPU Card with 4th Gen Intel® Core™ i7/i5 & Celeron® U-series Processor, SATA3, USB 3.0, Dual LANs and Dual DVI-D

## Features

- 4th gen Intel® Core™ i7/i5 & Celeron® U-series processors
- 2 DDR3L-1600 SO-DIMM for up to 16GB of memory
- 2 DVI-D with dual-view supported
- 2 SATA-600 with RAID 0/1
- USB 3.0 supported



### Core System

CPU	4th generation Intel® Core™ i7/i5 & Celeron® U-series processor, TDP up to 15W
System Memory	2 x 204-pin DDR3L-1600 SO-DIMM, up to 16GB
Chipset	SoC integrated
BIOS	AMI UEFI BIOS with OA 3.0 built
SSD	N/A
Watchdog Timer	225 levels, 1 to 255 sec.
Expansion Interface	Edge Connector A & B: 1 x PCIe x4 or 4 x PCIe x1 Gen2 Edge Connector C: 4 x USB 2.0
Battery	Lithium 3V/220 mAh
Power Requirements	Intel® Core™ i7-4650U, 8GB DDR3L-1600 x 2 +5V @ 1.2A, +12V @ 1.7A, +3.3V @ 0.2A
Dimensions	338 x 126 mm
Board Thickness	1.6 mm
Operating Temperature	0°C to +60°C (32°F to 140°F)
Humidity	10% to 95% relative humidity, non-condensing

### I/O

SATA	2 x SATA-600; support RAID 0/1 (Intel® Core™) 2 x SATA-600 (Intel® Celeron®)
Hardware Monitoring	Detect CPU/System temperature, voltage and fan speed
Ethernet	2 x 10/100/1000 Mbps Ethernet with Intel® i211AT; supports Wake-on-LAN, RPL/PXE Boot ROM
Audio	HD Codec audio as MIC-in/Line-in/Line-out/speaker-out with audio kit AX93242 (optional)
USB	2 x USB 3.0 6 x USB 2.0
Serial	2 x RS-232
PS/2 Combo Port	1 x PS/2 keyboard internal connector 1 x PS/2 mouse internal connector
TPM	N/A
SMBus	N/A
Others	1 x LPT with SPP/EPP/ECP supported 2 x Smart fan for system Fan1/Fan2

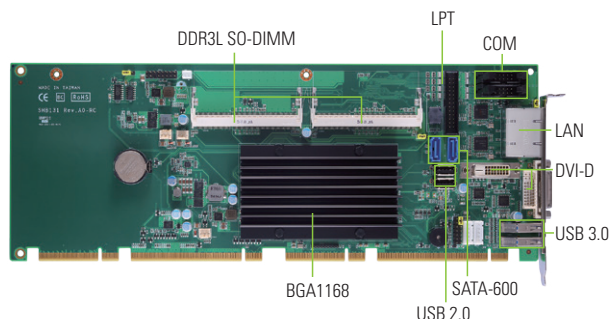

### Display

Chipset	Intel® HD Graphics
Memory Size	Intel® DVMT 5.0
Display Interface	2 x DVI-D

### Packing List

Standard		
Quick installation guide, user's manual/utility CD, cable		
Cable		
Part Number	Description	Qty
59380502000E	COM+print cable w/bracket	1
593826A0000E	SATA signal cable, 500 mm	1

### Ordering Information

Standard		
SHB131DGGA-i7-4650U (P/N: E38C131100)	PICMG 1.3 full-size CPU card with Intel® Core™ i7-4650U processor, DVI-D, 2 GbE LANs and audio	
SHB131DGGA-i5-4300U (P/N: E38C131101)	PICMG 1.3 full-size CPU card with Intel® Core™ i5-4300U processor, DVI-D, 2 GbE LANs and audio	
SHB131DGGA-Celeron-2980U (P/N: E38C131102)	PICMG 1.3 full-size CPU card with Intel® Celeron® 2980U processor, DVI-D, 2 GbE LANs and audio	



# SHB140

PICMG 1.3 Full-size CPU Card with LGA1151 7th/6th Gen Intel® Core™ Processor, Intel® Q170/H110, SATA3, USB 3.0, Dual LANs and DVI-I

## Features

- LGA1151 7th/6th gen Intel® Core™ processor
- Intel® Q170/H110 chipset
- 2 DDR4-2400 un-buffered DIMM for up to 32GB of memory (Kaby Lake)
- Intel® AMT 11 (Q170)
- Optional TPM supported
- PCIe Gen3 at 8GT/s supported
- Intel® vPro supported
- 10 USB 2.0 and 2 USB 3.0 (Q170)
- 6 SATA-600 with RAID 0/1/5/10 (Q170)



## Core System

CPU	LGA1151 socket 7th/6th gen Intel® Core™ processor, TDP up to 65W, Intel® vPro supported
System Memory	2 x 288-pin DDR4-2133/2400 un-buffered DIMM, up to 32GB
Chipset	Intel® Q170/H110
BIOS	AMI BIOS
SSD	N/A
Watchdog Timer	225 levels, 1 to 255 sec.
Expansion Interface	Edge Connector A: 1 x PCIe x16 Gen3 Edge Connector B: 1 x PCIe x4 or 4 x PCIe x1 Gen2 Edge Connector D: 4 x 32-bit PCI bus masters
Battery	Lithium 3V/220 mAH
Power Requirements	Intel® Core™ i7-6700, 8GB DDR4-2133/2400 x 2 +5V @ 1.38A, +12V @ 2.13A, +5VSB @ 0.72A, +3.3V @ 0.54A
Dimensions	338 x 126 mm
Board Thickness	1.6 mm
Operating Temperature	0°C to +60°C (+32°F to +140°F)
Humidity	10% to 95% relative humidity, non-condensing

## I/O

SATA	Q170: 6 x SATA-600, support RAID 0/1/5/10 H110: 4 x SATA-600
Hardware Monitoring	Detect CPU/system temperature, voltage and fan speed
Ethernet	1 x 10/100/1000 Mbps Ethernet with Intel® i219-LM; supports Wake-on-LAN, RPL/PXE Boot ROM, AMT 11 1 x 10/100/1000 Mbps Ethernet with Intel® i211-AT; supports Wake-on-LAN, RPL/PXE Boot ROM
Audio	HD Codec audio as MIC-in/Line-in/Line-out/Speaker-out with audio kit AX93242 (optional)
USB	Q170: 2 x USB 3.0 & 10 x USB 2.0 (6 ports onboard, 4 ports on SHB connector-C golden fingers) H110: 8 x USB 2.0 (4 ports onboard, 4 ports on SHB connector-C golden fingers)
Serial	5 x RS-232 1 x RS-232/422/485, mode selection by SW
PS/2 Combo Port	1 x PS/2 keyboard internal connector 1 x PS/2 mouse internal connector
TPM	Infineon SLB9635 for trusted platform (optional)
SMBus	N/A
Others	2 x Smart fan for system Fan1/Fan2

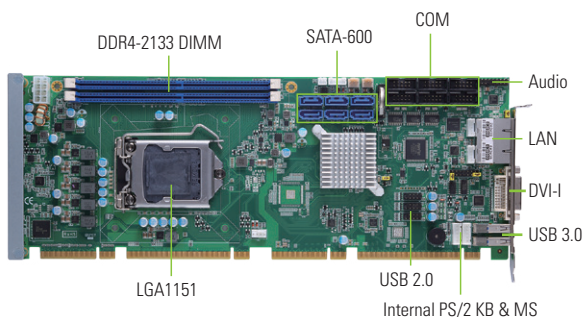

## Display

Graphic	Intel® HD Graphic
Memory Size	Share system memory
Display Interface	1 x DVI-I

## Packing List

### Standard

Quick installation guide, user's manual/utility CD, cable

### Cable

Part Number	Description	Qty
593826A0000E	SATA signal cable, 500 mm	1

## Ordering Information

### Standard

SHB140DGGA (P/N: E38C140101)	PICMG 1.3 full-size CPU card with LGA1151 socket, Intel® Q170, DVI-I, 2 GbE LANs, audio and PCIe x1
SHB140DGGA (P/N: E38C140102)	PICMG 1.3 full-size CPU card with LGA1151 socket, Intel® Q170, DVI-I, 2 GbE LANs, audio and PCIe x4
SHB140DGGA (P/N: E38C140107)	PICMG 1.3 full-size CPU card with LGA1151 socket, Intel® Q170, DVI-I, 2 GbE LANs, audio and PCIe x4, TPM (limited to MoQ)
SHB140DGGA (P/N: E38C140100)	PICMG 1.3 full-size CPU card with LGA1151 socket, Intel® H110, DVI-I, 2 GbE LANs, audio and PCIe x1
SHB140DGGA (P/N: E38C140104)	PICMG 1.3 full-size CPU card with LGA1151 socket, Intel® H110, DVI-I, 2 GbE LANs, audio and PCIe x4
SHB140DGGA (P/N: E38C140105)	PICMG 1.3 full-size CPU card with LGA1151 socket, Intel® H110, DVI-I, 2 GbE LANs, audio and PCIe x4, TPM (limited to MoQ)

### Optional

5938A808010E	2 x USB 2.0 cable with bracket, P=2.54 mm, L=190 mm
5948C122800E	2 x USB 3.1(Gen1) cable with bracket, L=400 mm
59380000290E	PS/2 keyboard & mouse cable with bracket
593826A0000E	SATA signal cable/red, L=500mm
E393242100	AX93242-RC HD audio converter kit
59380402010E	1 x COM port cable with bracket, P=2.54 mm, L=300 mm
59380703000E	2 x COM port cable with bracket, P=2.54 mm, L=300 mm
594826A0010E	DVI-I to DVI-D+VGA Y cable



# SHB150 NEW

PICMG 1.3 Full-size CPU Card with LGA1151 8th Gen Intel® Core™ Processor, Intel® C246/Q370/H310, SATA3, USB 3.1 Gen1/Gen2, Dual LANs and DVI-I

## Features

- LGA1151 8th gen Intel® Core™ processor (Coffee Lake)
- Intel® C246/Q370/H310 chipset
- 2 DDR4-2666/2400 Long-DIMM for up to 32GB of memory
- Supports Intel® AMT and vPro (C246/Q370)
- TPM 2.0 supported (optional)
- Supports M.2 Key M (C246/Q370)

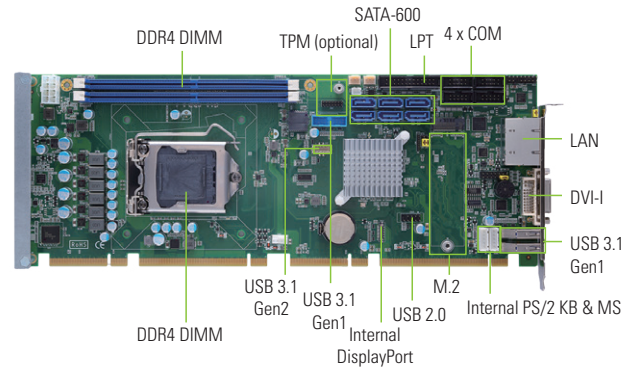

### Core System

CPU	LGA1151 socket 8th gen Intel® Core™ processor
System Memory	2 x 288-pin 2666/2400 un-buffered ECC DIMM, up to 32GB (C246) 2 x 288-pin 2666/2400 un-buffered DIMM, up to 32GB (Q370/H310)
Chipset	Intel® C246/Q370/H310
BIOS	AMI BIOS
SSD	M.2 2280 Key M, PCIe x4 signal (C246, Q370)
Watchdog Timer	225 levels, 1 to 255 sec.
Expansion Interface	Edge Connector A: 1 x PCIe x16 Gen3 Edge Connector B: 1 x PCIe x4 or 4 x PCIe x1 Gen3 Edge Connector D: 4 x 32-bit PCI bus masters
Battery	Lithium 3V/220 mAh
Power Requirements	TBC
Dimensions	338 x 126 mm
Board Thickness	1.6 mm
Operating Temperature	0°C to +60°C (+32°F to +140°F)
Humidity	10% to 95% relative humidity, non-condensing

### I/O

SATA	C246/Q370: 6 x SATA-600, support RAID 0/1/5/10 H310: 4 x SATA-600
Hardware Monitoring	Detect CPU/system temperature, voltage and fan speed
Ethernet	1 x 10/100/1000 Mbps Ethernet with Intel® i219-LM; supports Wake-on-LAN, RPL/PXE Boot ROM, AMT 1 x 10/100/1000 Mbps Ethernet with Intel® i211-AT; supports Wake-on-LAN, RPL/PXE Boot ROM
Audio	HD Codec audio as MIC-in/Line-in/Line-out/Speaker-out with audio kit AX93242 (optional)
USB	C246/Q370: 2 x USB 3.1 Gen2, 4 x USB 3.1 Gen1 & 6 x USB 2.0 (2 ports onboard, 4 ports on SHB connector-C golden fingers) H310: 4 x USB 3.1 Gen1 & 6 x USB 2.0 (2 ports onboard, 4 ports on SHB connector-C golden fingers)
Serial	2 x RS-232 2 x RS-232/422/485, mode selection by SW
PS/2 Combo Port	1 x PS/2 keyboard internal connector 1 x PS/2 mouse internal connector
TPM	TPM 2.0 (optional)
SMBus	N/A
Others	1 x LPT 1 x Smart fan for system Fan1/Fan2

### Display

Graphic	Intel® HD Graphic
Memory Size	Share system memory
Display Interface	1 x DVI-I 1 x DisplayPort (header)

### Packing List

#### Standard

Quick installation guide, user's manual/utility CD

### Ordering Information

#### Standard

SHB150DGG-Q370	PICMG 1.3 full-size CPU card with LGA1151 socket, Intel® Q370, DVI-I, 2 GbE LANs, and PCIe x1
SHB150DGG-Q370	PICMG 1.3 full-size CPU card with LGA1151 socket, Intel® Q370, DVI-I, 2 GbE LANs, and PCIe x4

#### Optional

5938A808010E	2 x USB 2.0 cable with bracket, P=2.54 mm, L=190 mm
5948C122800E	2 x USB 3.1 (Gen1) cable with bracket, L=400 mm
59380000290E	PS/2 keyboard & mouse cable with bracket
593826A0000E	SATA signal cable/red, L=500mm
E93242100	AX93242-RC HD audio converter kit
59380402010E	1 x COM port cable with bracket, P=2.54 mm, L=300 mm
59380703000E	2 x COM port cable with bracket, P=2.54 mm, L=300 mm
594826A0010E	DVI-I to DVI-D+VGA Y cable
83935151000E	TPM 2.0 module (AX93515)

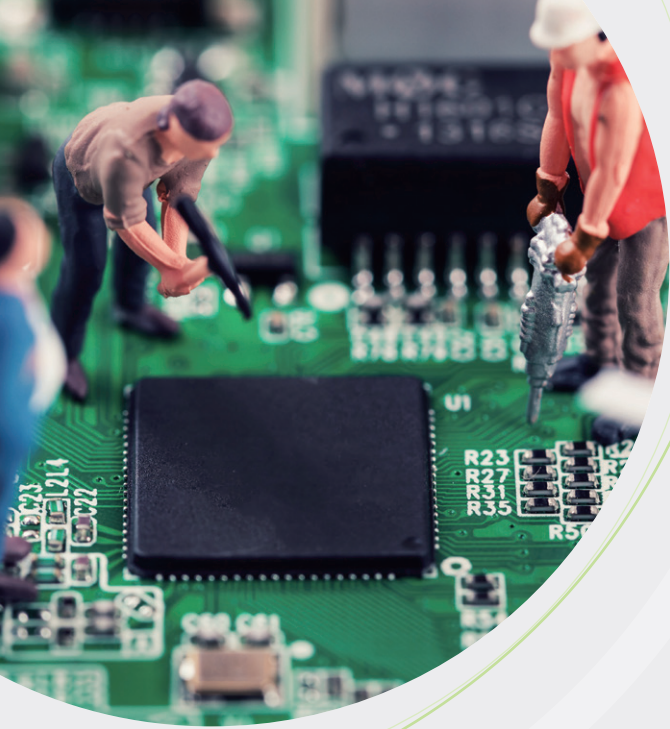

System on Modules

3.5" Embedded Boards

Pico-ITX SBCs

Mini-ITX Motherboards

ATX/Mirco ATX Motherboards

Slot CPU Cards

Smart Display Module

PCI Express Cards

# Boards and Modules

# 7

## Smart Display Module

Axiomtek's advanced smart display module has been chosen by many industry-leading retail stores and grocery chains, to enhance customer shopping experience and improve store operations. The excellent performance of Module-series which can be integrated into the sleekest all-in-one designs offers customers speed, convenience and privacy through self-checkout terminals in delivering a comfortable shopping environment.

Selection Guide

99



SDM300S

Intel® Smart Display Module Small (SDM-S) with Intel® Pentium® Processor N4200 & Celeron® Processor N3350

100

# Smart Display Module

## Selection Guide

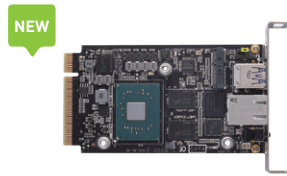

Features/Models	SDM300S
<b>Form Factor</b>	Intel® SDM Small
<b>CPU Level</b>	Intel® Pentium® N4200 & Celeron® N3350
<b>CPU Socket</b>	Onboard
<b>CPU FSB Frequency</b>	N/A
<b>Core Logic Chipset</b>	SoC integrated
<b>Memory Type</b>	LPDDR4
<b>Max. DRAM Capacity</b>	4GB/8GB (optional)
<b>Cache RAM Capacity</b>	SoC integrated
<b>BIOS</b>	AMI UEFI BIOS
<b>Watchdog Timer</b>	255 levels, 1 to 255 sec./min.
<b>SSD</b>	32/64GB eMMC onboard
<b>Digital I/O</b>	N/A
<b>Intel® AMT</b>	N/A
<b>TPM</b>	N/A
<b>I/O Interface</b>	Golden finger: PCIe x8 (the pin define follows SDM specification) 1 x USB 3.0 1 x HDMI 1.4 1 x DisplayPort 1.2 1 x Serial TX/RX 2 x I <sup>2</sup> C
<b>I/O</b>	1 x 10/100/1000 Mbps (Intel® i211-AT) 2 x USB 3.0
<b>Hardware Monitoring</b>	N/A
<b>SMBus</b>	Yes
<b>Expansion Interface</b>	1x M.2 E key 1x PCIe x1 thru SDM edge connector
<b>Power Input</b>	Through SDM edge connector +12V & +3.3VBS
<b>Battery</b>	Lithium 3 V/220 mAH
<b>Operating Temperature</b>	0°C to+55°C (+32°Fto+131°F)
<b>Relative Humidity</b>	10% to 95%, non-condensing
<b>EMI Compliance</b>	CE

# SDM300S NEW

Intel® Smart Display Module Small (SDM-S) with Intel® Pentium® Processor N4200 & Celeron® Processor N3350

## Features

- Intel® Smart Display Module (Intel® SDM) specification
- Intel® Pentium® processor N4200 & Celeron® processor N3350 (Apollo Lake)
- 4GB LPDDR4 memory onboard (8GB optional)
- 64GB eMMC onboard (32G optional)
- One M.2 Key E 2230 slot
- Two USB 3.0 and one GbE LAN
- Small design for easy integration into slim displays
- Optimized for digital signage, public kiosks, professional monitors, point-of-sale
- Projections for magic mirrors, beside terminals, hospitality, and more

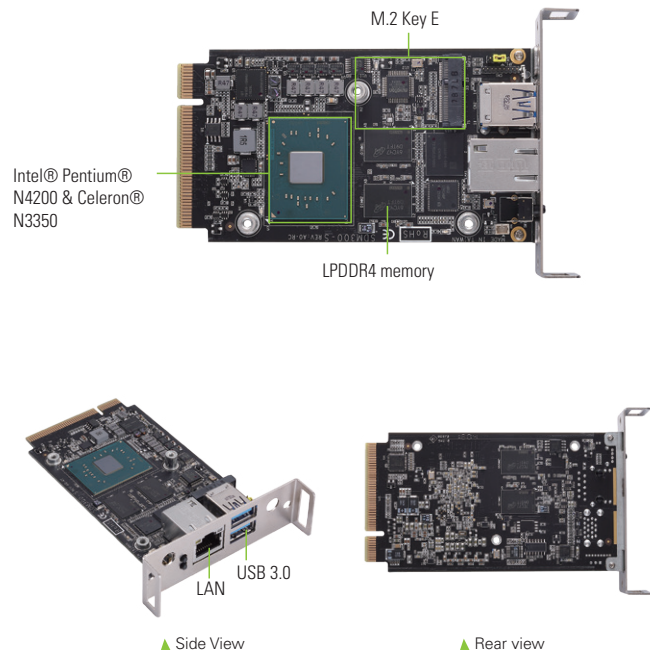

## Core System

CPU	Intel® Pentium® processor N4200, Celeron® processor N3350 onboard
System Memory	LPDDR4 4GB memory onboard (8GB optional)
Chipset	SoC integrated
SSD	64GB eMMC onboard (32G optional)
WatchDog Timer	255 levels, 1 to 255 sec./min.
Expansion Interface	1 x M.2 Key E 2230 slot
Battery Lithium	Lithium 3 V/220 mAh
Power Input	Through SDM edge connector +12V & +3.3VBS
Dimensions	100 x 60 mm
Board Thickness	1.6 mm
Operating Temperature	0°C to +55°C (+32°F to +131°F)
Humidity	10% to 95% relative humidity, non-condensing

## I/O

I/O Interface	Golden Finger	Standard PCIe x8 (98 pins)
	SDM I/O	1 x USB 3.0 1 x HDMI 1.4 1 x DisplayPort 1.2 1 x Serial TX/RX 2 x I <sup>2</sup> C
Rear I/O	1 x 10/100/1000 Mbps with Intel® i211-AT; supports Wake-on-LAN, PXE Boot ROM 2 x USB 3.0	

## Display

Chipset	Intel® HD Graphics 505/500 Supports Gfx - DX12.0, OCL 2.0, OGL 4.3
Display Interface (via SDM edge connector)	1 x DisplayPort 1.2 (4096 x 2304 @ 60p) 1 x HDMI 1.4 (3840 x 2160 @ 30p)

## Packing List

Quick installation guide

## Ordering Information

Standard	
SDM300S-N4200-4GB	SDM-S module with Intel® Pentium® processor N4200, DisplayPort, HDMI, GbE LAN and USB 3.0
SDM300S-N3350-4GB	SDM-S module with Intel® Celeron® processor N3350, DisplayPort, HDMI, GbE LAN and USB 3.0

## Optional

SDB100	SDM carrier board
--------	-------------------



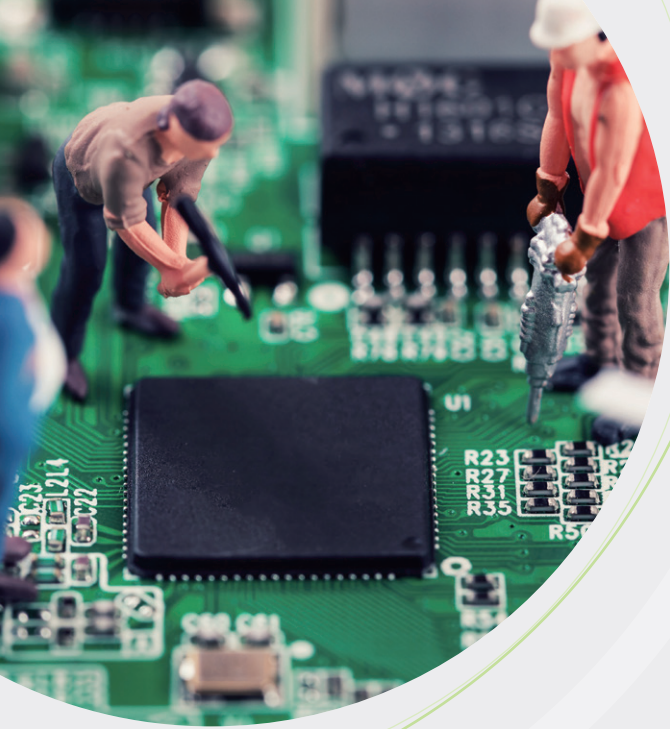

System on Modules

3.5" Embedded Boards

Pico-ITX SBCs

Mini-ITX Motherboards

ATX/Mirco ATX Motherboards

Slot CPU Cards

Smart Display Module

PCI Express Cards



# Boards and Modules

# 8

## PCI Express Cards

Axiomtek develops a full spectrum of add-on cards for machine vision and data acquisition applications to help customers accelerating their design and reducing development costs.

### Machine Vision

 AX92320	4-port PCI Express GigE Frame Grabber Card	103
 AX32350	Real-Time Vision I/O Card	104

### Data Acquisition (DAQ)

 AX92351	32-CH Isolated Digital I/O PCI Express Card with Digital Filter	105
---	---	-----

# AX92320 NEW

## 4-port PCI Express GigE Frame Grabber Card

### Features

- PCI Express x4 compliant
- 4 independent Gigabit PoE ports
- Supports 9.5KB Jumbo Frame and IEEE 1588
- Compliant with IEEE802.3at to deliver 30W at 54 VDC per port
- Up to 20/120W PoE power from PCIe 6-pin ATX power connector
- 0°C to +60°C operating temperature range
- PoE power management software
- Supports LAN port smart on/off

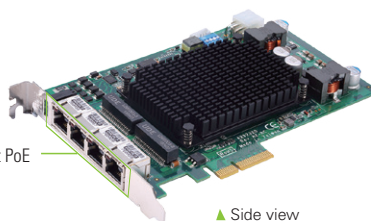
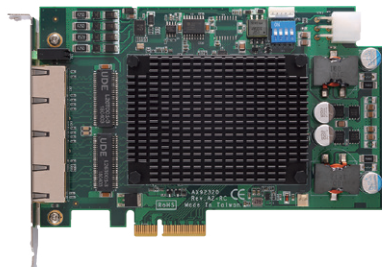

### Introduction

The AX92320 PoE (Power over Ethernet) card supports four independent Gigabit PoE ports, providing up to 30W at 54 VDC of power per port. The AX92320 can fit in the PCI Express slot of any multi-channel vision control systems. It is designed to help customers develop and deploy machine vision and surveillance applications. Applications will greatly benefit through reduce cost, simpler installation and lower maintenance. Moreover, the AX92320 has a wide operating temperature of 0°C to 60°C (32°F to 140°F), making it suitable to be used in most severe environments.

### Specifications

Ethernet Communications	
Ethernet Port	4 GbE LANs by Intel® i210-AT controller, support 9.5KB jumbo frame and IEEE 1588
PoE Capability	IEEE 802.3at compliant, each port delivers up to 30W at 54 VDC
Speed	10/100/1000 Mbps
Port Connector	8-pin RJ-45
Power Requirements	
Input Voltage	12 VDC or 24 VDC
Overload Protection	Yes
Connection	6-pin ATX power connector
Output PoE Power	Max. 20W w/ PCIe slot Max. 120W w/ 6-pin ATX power connector
Power Requirements	Power from PCIe slot (max. 20W PoE power output) 2.1A @ +12V 1.2A @ +3.3V Power from ATX power connector (max. 120W PoE power output) 12A @ +12V or 6A @ +24V 1.2A @ +3.3V (from PCIe slot)
General Specifications	
Bus Type	PCI Express x4
Operating Temperature	0°C to +60°C (+32°F to +140°F) (with air flow)
Storage Temperature	-20°C to +80°C (-4°F to +176°F)
Humidity	5% to 95%, non-condensing
Dimensions (W x D)	168 x 111 mm
EOS Support	Windows® 7, Windows® 10 (32/64-bit)

### Ordering Information

AX92320 (P/N: E392320100)	4-port PCI Express GigE frame grabber card
PoE Power Cable (P/N: 59492320700E)	4P 3.0/6P 4.2, L=10 cm (only be used with IPC962/IPC964)

### Packing list

Standard
User's manual, utility, CD and I/O bracket

# AX92350 NEW

## Real-Time Vision I/O Card

### Features

- Integrated vision I/O
  - 4-CH trigger input
  - 4-CH or 8-CH trigger output
  - 4-CH LED lighting control (LED trigger output channels are defined by software settings)
  - 1-CH quadrature encoder input
  - 8-CH isolated DI, 8 CH isolated DO
  - 1-CH auto measurement function
- Programmable interrupt functions
- PCI Express x1 compliant
- Flexible design for vision inspection

### Introduction

The AX92350 integrates various I/O features for machine vision applications, including trigger input and output with microsecond-scale real-time control, an auto measurement timer, as well as LED lighting control with dimming support. It also provides an encoder input function suited for conveyor applications in factory automation. The AX92350 can fit in the PCI Express slot of any vision control system to simplify deployment and maintenance of your machine vision platform.

### Specifications

Isolated Digital Input	
Channels	8-CH
Type	Sink/Source
Input Voltage	On (Logic 1): 10 to 30 VDC or dry contact Off (Logic 0): 0 to 3 VDC
Impedance	7.5KΩ
Isolated Digital Output	
Channels	8-CH
Output type	Sink, open collector
Supply voltage	5 to 30 VDC
Sink current	Max. 200 mA per channel
Isolated Trigger Input	
Channels	4-CH
Type	Sink
Input range	On (Logic 1): 3 to 30 VDC Off (Logic 0): 0 to 2 VDC
Response Time	1us (from trigger input to trigger output)
Input Filter	Programmable de-bounce filter
Isolated Encoder Input	
Channels	1-CH 16-bit incremental quadrature encoder input (A/B/Z)
Type	Differential, single-ended
Counter Mode	x4
Frequency Input	Max. 1MHz
Isolated Trigger Output	
Channels	4-CH or 8-CH
Output Voltage	12 VDC
Output Impedance	1KΩ
Response Time	1us (from trigger input to trigger output)
Configuration	Derived from 4CH trigger input or encoder input. Can set the pulse delay time and duration time Trigger output channel 4,5,6,7 can only be selected either for trigger output or for LED lighting control
Auto Measurement	Timer that measures response interval between trigger input and trigger output
Interrupt	
Sources	Two interrupt sources from DI, trigger input, encoder Z phase and encoder check pointer
LED Lighting Control	
Channels	4-CH
Output Voltage	24 VDC, Max. 0.5A per channel

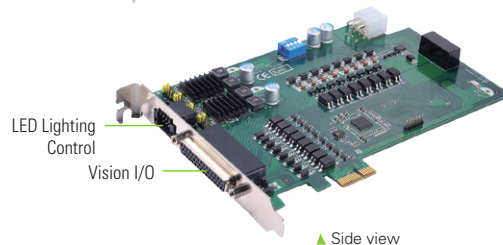
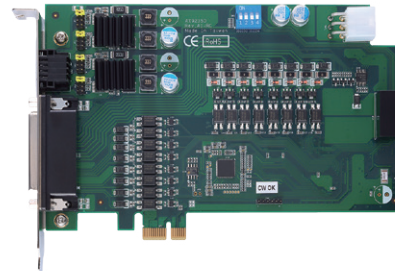

Output Current	Each channel can be set 100mA/250mA/350mA/500mA output by jumper, support dimming control
Mode	Trigger mode
External Power Supply Connector	6-pin ATX 2x3 connector for connection to 12V external power supply when LED power consumption exceeds 24V @500mA
Connector	4-CH LED lighting control via a 8 pin terminal connector
General Specifications	
Bus Type	PCI Express x1
I/O Connector	D-sub 44-pin female connector
Isolation Voltage	1000 VDC
Power Requirements	50mA @ +3.3V (Max.) 220mA @ +12V (Max.) Note: Excluding the power consumption of 24V LEDs
Dimensions	168 x 107 mm
Board ID	Yes, 4-bit
Operating Temperature	0°C to +60°C (32°F to +140°F) with air flow
Storage Temperature	-20°C to +80°C (-4°F to +176°F)
Humidity	5 to 95% RH, non-condensing
Software Support	
EOS Support	Windows® 7/Windows® 10 (32/64bit)
Software Compatibility	C#, C/C++, Visual Basic

### Ordering Information

AX92350 (P/N: E392350100)	Vision I/O card
Vision Power Cable (P/N: 59492350700E)	4P 4.2/6P 4.2, L=10 cm (only be used with IPC962/IPC964)

### Accessories

5A244AP1200E	44-pin DIN-rail terminal board DM44-AP12
594DM443500E	44-pin D-SUB cable, L=1m WHDM44/1.0-6954
594DM443510E	44-pin D-SUB cable, L=2m WHDM44/2.0-6954
594DM443520E	44-pin D-SUB cable, L=3m WHDM44/3.0-6954

\*Specifications and certifications are based on options and may vary.

### Packing list

<b>Standard</b>	User's manual, utility, CD and I/O bracket, CN-terminal block 4 x 2
-----------------	---

# AX92351 NEW

## 32-CH Isolated Digital I/O PCI Express Card with Digital Filter

### Features

- 32-CH isolated digital input (compatibility: sink and source)
- 32-CH isolated digital output (with output status read back)
- Interrupt capability (smart interrupt)
- Digital filter function
- Supports board ID

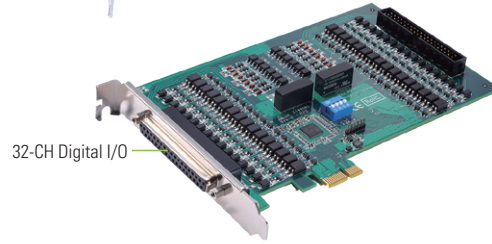
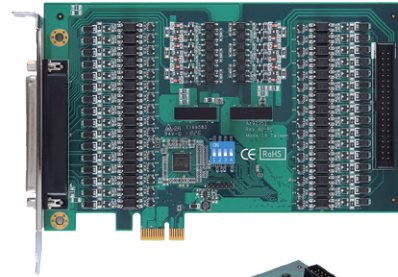

▲ Side view

### Introduction

The AX92351 is a 32-ch isolated DI and 32-ch isolated DO card. It comes with DI channels that support both sink and source input types for maximum application flexibility. The AX92351 also integrates digital filter and I/O interrupt (smart interrupt) functions, making it specifically suitable for factory automation, industrial on/off control and switch status sensing.

### Specifications

Isolated Digital Input	
Isolation Voltage	2KV
Channels	32
Compatibility	Sink or source, dry or wet contact
Input Voltage	Input high voltage: 10 to 30V Input low voltage: 0 to 3V
Input Impedance	7.5KΩ
Interrupt Sources	Interrupt 0 (DI: CH 0-4) and 1 (DI: CH 8-12)
Response Speed	4KHz
Digital Filter	Yes
Isolated Digital Output	
Isolation Voltage	2KV
Channels	32
Compatibility	Sink or Source, Open collector
Output Current	100 mA/+30 VDC for all channels @ 100% duty
Supply Voltage	Max. 30 VDC
Max. Voltage Drop	3.5 VDC @ 100mA
Response Speed	4KHz
Over Current Protection	Yes
General Specifications	
Bus Type	PCI Express x1
Power Requirements	625mA @ +3.3V (Max.) 66mA @ +12V (Max.)
Dimensions	168 x 107 mm
Board ID	Yes, 4-bit
I/O Connector	Female DB37 x1 40-pin box header x1
Operating Temperature	0°C to +60°C (+32°F to +140°F)
Storage Temperature	-20°C to +80°C (-4°F to +176°F)
Humidity	5 to 95% RH, non-condensing
Software Support	
EOS Support	Windows® 7/Windows® 10 (32/64bit), Interval zero real-time OS (64bit)
Software compatibility	C#, C/C++, Visual Basic

### Digital Filter Table for DI Channels

16 stages per DI channel; each channel can be set independently

Setting Data	Digital Filter Time	Setting Data	Digital Filter Time	Setting Data	Digital Filter Time	Setting Data	Digital Filter Time
0	function disable	4	700us	8	3ms	12	7ms
1	100us	5	900us	9	4ms	13	8ms
2	300us	6	1ms	10	5ms	14	9ms
3	500us	7	2ms	11	6ms	15	10ms

37-pin Female Connector (CN1)

40-pin Box-Header (CN2)

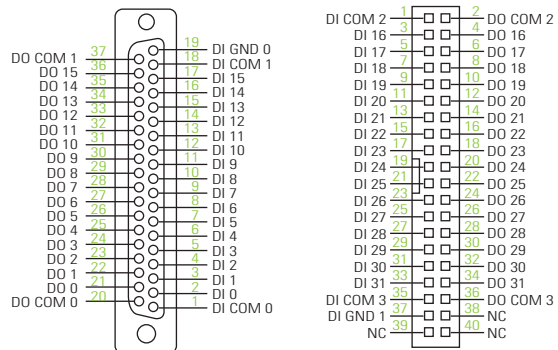

### Ordering Information

AX92351	32-CH isolated digital I/O with digital filter (includes one P/N: E392351100)
	40-pin box-header to 37-pin female cable)

### Accessories

5A237AP0200E	37-pin DIN-rail terminal board DM37-AP02
594DM373500E	37-pin D-Sub cable, L=1m WHDM37/1.0
594DM373510E	37-pin D-Sub cable, L=2m WHDM37/2.0
594DM373520E	37-pin D-Sub cable, L=3m WHDM37/3.0

### Packing list

#### Standard

User's manual/utility CD and I/O bracket, 40-pin to DB37 cable







# Table of Contents

## Systems and Platforms

### 1 Embedded Systems

---

	Selection Guide	113
	eBOX100-312-FL Fanless Embedded System with Intel® Celeron® N3350 2.4 GHz/ Pentium® N4200 2.5 GHz, 2 HDMI, 2 GbE LANs and 6 USB	119
	eBOX560-500-FL Fanless Embedded System with Intel® Core™ i7-6600U 3.4 GHz/ i5-6300U 3 GHz/i3-6100U 2.3GHz/Celeron® 3955U 2.0 GHz, 2 HDMI, 2 GbE LANs, 4 USB 3.0, 2 COM and PCI Express Mini Card Slot	120
	eBOX560-512-FL Fanless Embedded System with Intel® Core™ i5-7300U 3.5 GHz/ Celeron® 3965U 2.2 GHz, 2 HDMI, 2 GbE LANs, 4 USB 3.0 and PCI Express Mini Card Slot	121
<b>NEW</b>	eBOX560-900-FL Fanless Edge System with NVIDIA® Jetson™ TX2, 1 HDMI 2.0, 2 GbE LANs and 1 USB 2.0	122
	eBOX565-312-FL Fanless Embedded System with Intel® Celeron® processor N3350, 2 HDMI, 4 USB 3.0, 2 COM, 1 GbE and PoE	123
	eBOX565-500-FL Fanless Embedded System with Intel® Core™ i5-6300U 2.4 GHz/ i3-6100U 2.3 GHz/Celeron® 3955U 2.0 GHz, 2 HDMI, 2 GbE LANs, 4 USB 3.0, 2 COM and 9 to 36 VDC	124
<b>NEW</b>	eBOX625-312-FL Fanless Embedded System with Intel® Celeron® N3350 2.4 GHz/ Pentium® N4200 2.5 GHz, HDMI, VGA, 2 GbE LANs, 6 USB and 3 COM	125
	eBOX625-853-FL Fanless Embedded System with Intel® Celeron® N3160 2.24 GHz, VGA/HDMI, 4 COM, 2 GbE LANs, 4 USB, and 2 PCI Express Mini Card Slots	126
	eBOX626-853-FL Fanless Embedded System with Intel® Celeron® N3160 2.24 GHz, VGA/HDMI, 4 COM, 2 GbE LANs, 4 USB, 2 PCI Express Mini Card Slots and 9 to 36 VDC	127
<b>NEW</b>	eBOX627-312-FL Fanless Embedded System Intel® Celeron® N3350 2.4 GHz/ Pentium® N4200 2.5 GHz, HDMI, 2 GbE LANs, 6 USB, 4 COM and 9 to 36 VDC	128
<b>NEW</b>	eBOX638-842-FL Fanless Embedded System with Intel® Celeron® Processor J1900 2.0 GHz, VGA/HDMI, 4 COM, 6 USB, 2 PCI or 2 PCIe Slots and 9 to 36 VDC Input	129

	eBOX640-500-FL	Fanless Embedded System with LGA1151 Socket 6th/7th Gen Intel® Core™ & Celeron® Processor, Intel® H110, HDMI, DisplayPort, VGA, 6 USB, 4 COM, PCI Express Mini Card Slot and 10 to 30 VDC	130
	eBOX670-891-FL	Fanless Embedded System with LGA1151 Socket 6th/7th Gen Intel® Core™ i7/i5/i3 & Celeron® Processor, Intel® Q170, 2 HDMI, DisplayPort, 4 GbE LANs, 6 USB, Dual PCI Express Mini Card Slots and Wide Range DC-in	131
	eBOX671-517-FL	Fanless Embedded System with LGA1151 Socket 7th/6th Gen Intel® Core™ i7/i5/i3 & Celeron® Processor, Intel® Q170, VGA/DVI-D/HDMI, 8-CH PoE, 6 USB and 9 to 36 VDC	132
	eBOX671-521-FL	Fanless Embedded System with LGA1151 8th Gen Intel® Core™ i7/i5/i3 & Celeron® Processor, 4-CH PoE and Optional MXM Graphics Module Supported	133
	eBOX700-891-FL	Fanless Embedded System with LGA1151 Socket 6th/7th Gen Intel® Core™ i7/i5/i3 & Celeron® Processor, Intel® H110, 2 HDMI, DisplayPort, 4 GbE LANs, 6 USB, PCIe x4/PCI Slot and 9 to 36 VDC	134
	eBOX800-841-FL	Rugged IP67-rated Fanless Embedded System with Intel® Atom® Processor E3845 1.91 GHz, VGA, 2 GbE LANs, 2 USB, 2 COM and 9 to 36 VDC	135
	eBOX800-511-FL	Rugged IP67-rated Fanless Embedded System with Intel® Core™ i5-7300U/Celeron® 3965U, VGA, GbE LAN, 2 USB, 2 COM and 9 to 36 VDC	136
	eBOX800-900-FL	Rugged IP67-rated Fanless Edge System with NVIDIA® Jetson™ TX2, HDMI, GbE LAN, 1-CH PoE, USB 2.0 and 100 to 240 VAC Power Input	137

## 2 Transportation Embedded Systems

	Selection Guide		139
	tBOX810-838-FL	Fanless Embedded System with Intel® Atom® Processor E3845/E3827 for Vehicle, Railway and Marine PC	141
	tBOX100-838-FL	Fanless Embedded System with Intel® Atom® Processor E3845 for Vehicle, Railway and Marine PC	143
	tBOX324-894-FL	Fanless Embedded System with 7th Gen Intel® Core™ i7/i5/i3 & Celeron® for Vehicle, Railway and Marine PC	145
	tBOX300-510-FL	Fanless Embedded System with 7th Gen Intel® Core™ i7/i5/i3 & Celeron® Processor for Vehicle, Railway and Marine PC	147
	tBOX500-510-FL	Fanless Embedded System with 7th Gen Intel® Core™ i7/i5/i3 & Celeron® Processors for Vehicle, Railway and Marine PC	149
	UST500-517-FL	Fanless Embedded System with 7th/6th Gen Intel® Core™, Pentium® and Celeron® Processor for Vehicle and Railway PC	151

# 3 DIN-rail Embedded Systems

Selection Guide 155

## x86-based Series



IC0120-83D	Robust DIN-rail Fanless Embedded System with Intel® Celeron® Processor N3350, COM or CAN, 2 LANs, 2 USB and DIO	159
IC0320-83C	Robust DIN-rail Fanless Embedded System with Intel® Celeron® Processor N3350/Pentium® Processor N4200, COM or CAN, PoE LAN and DIO	161
IC0100-839	Robust DIN-rail Fanless Embedded System with Intel® Celeron® Processor N3350, 2 COM, LAN, 2 USB and DIO	163
IC0300-83B	Robust DIN-rail Fanless Embedded System with Intel® Celeron® Processor N3350/Pentium® Processor N4200, Isolated COM, LAN and DIO	165
IC0300	Robust DIN-rail Fanless Embedded System with Intel® Atom® Processor E3815/E3827, 4 COM, 2 LANs, DIO and RTC	167
IC0310	Robust DIN-rail Fanless Embedded System with Intel® Celeron® Processor N3060/N3160, 2 COM, 4 USB, 2 LANs (1 PoE PD), DIO and RTC	169
 IC0500-518	Fanless Embedded System with 7th Gen Intel® Core™ i7/i5/i3 & Celeron® Processors Dual Modular I/O Expansion Design	171
rBOX510-6COM (ATEX/C1D2)	ATEX & CID2 Anti-Explosion Certified Robust DIN-rail Fanless Embedded System with Intel® Atom® Processor E3827 (1.75 GHz)	173

## ARM-based Series

IRU152	Robust RISC-based DIN-rail Fanless Embedded System with i.MX 6UL Processor, COM, LAN, DIO (2-in/2-out), 4 AI Channels (16-bit, 250 kS/s) and 2 PCIe Mini Card Slots	175
IRU151	Robust RISC-based DIN-rail Fanless Embedded System with i.MX 6UL Processor, COM, LAN, DIO (2-in/2-out), 4 AI Channels (16-bit, 100 S/s) and 2 PCIe Mini Card Slots	177
IRU131	Robust RISC-based DIN-rail Fanless Embedded System with i.MX 6UL Processor, COM, LAN, DIO (2-in/2-out) and 2 PCIe Mini Card Slots	179
IFB122	Robust RISC-based DIN-rail Fanless Embedded System with i.MX 6UL Processor, 2 COM, 2 LANs and DIO (2-in/1-out)	181
IFB112	Robust RISC-based DIN-rail Fanless Embedded System with i.MX 6UL Processor, COM, CANbus, 2 LANs and DIO (2-in/1-out)	183
IFB125	Robust RISC-based DIN-rail Fanless Embedded System with i.MX 6UL Processor, COM, SPI, I2C, 2 LANs and DIO (2-in/1-out)	185

## 4 Digital Signage Players

---

Selection Guide		189
<b>OPS+ &amp; OPS Series</b>		
 OPS700-520	Open Pluggable Specification-Plus (OPS+) Digital Signage Player with 8th Gen Intel® Core™ i7/i5/i3 & Celeron® Processor, Intel® Q370 and TPM 2.0	191
 OPS500-520-H	Open Pluggable Specification (OPS) Digital Signage Player with 8th Gen Intel® Core™ i7/i5/i3 & Celeron® Processor, Intel® H310 and TPM 2.0	192
OPS500-501	Open Pluggable Specification (OPS) Digital Signage Player with 6th/7th Gen Intel® Core™ i7/i5/i3 & Celeron® Processor, Intel® Q170 and AMT 11.0	193
OPS500-501-H	Open Pluggable Specification (OPS) Digital Signage Player with 7th/6th Gen Intel® Core™ i7/i5/i3 & Celeron® Processor and Intel® H110	194
OPS300-310	Open Pluggable Specification (OPS) Digital Signage Player with Intel® Celeron® Processor N3350 and TPM 2.0	195
<b>DSP Series</b>		
 DSP300-318	Digital Signage Player with Intel® Pentium® Processor N4200 & Celeron® Processor N3350, DP++/HDMI, 2 GbE LANs and 4 USB	196

## 5 Embedded MicroBoxes

---

Selection Guide		199
AX60630	Embedded MicroBox for Low Power Mini-ITX SBC	200
AX60650	Embedded MicroBox for Mini-ITX SBC	201
ECM100	Embedded Computing Machine Chassis for Mini-ITX SBC	202
ECM300	Embedded Computing Machine Chassis with 2 Expansion Slots for Mini-ITX SBC	203

## 6 Industrial Systems

---

Selection Guide		205
IPC962-511-FL	2-slot Fanless Industrial System with LGA1151 Socket 7th/6th Gen Intel® Core™ i7/i5/i3 & Celeron® Processor (up to 3.4 GHz), Intel® H110, Front-access I/O, PCIe and PCI Slots	207
 IPC962-512-FL	2-slot Fanless Industrial System with LGA1151 Socket 7th/6th Gen Intel® Core™ i7/i5/i3 & Celeron® Processor (up to 3.4 GHz), Intel® Q170, Front-access I/O, PCIe and PCI Slots	209

IPC964-512-FL	4-slot Fanless Industrial System with LGA1151 Socket 7th/6th Gen Intel® Core™ i7/i5/i3 & Celeron® Processor (up to 3.4 GHz), Intel® Q170, Front-access I/O, PCIe and PCI Slots	211
IPC922-215-FL	2-slot Fanless Industrial System with Intel® Celeron® Processor J1900 (up to 2.42 GHz), Front-access I/O, PCIe and PCI Slots	213
IPC932-230-FL	2-slot Fanless Industrial System with 4th Gen Intel® Core™ i7/i5/i3 & Celeron® processor (up to 3.3 GHz), Intel® Q87, Front-access I/O, PCIe and PCI Slots	215
<b>NEW</b> IPC310-501	Wall Mount Industrial System with LGA1151 Socket 7th/6th Gen Intel® Core™ Processor, Intel® H110, USB 3.0, SATA 3.0, Dual LANs, VGA/DisplayPort/HDMI and mSATA	217

## 7 Intelligent Platform Solutions

Selection Guide		220
<b>NEW</b> IPS960-511-PoE	Vision System with LGA1151 Socket 7th/6th Gen Intel® Core™ i7/i5/i3 & Celeron® , Intel® H110, 4 PoE, 4 USB 3.0, and Real-time Vision I/O	221
<b>NEW</b> IPS962-512-PoE	Vision System with LGA1151 Socket 7th/6th Gen Intel® Core™ i7/i5/i3 & Celeron®, Intel® Q170, 4 PoE, 4 USB 3.0, and Real-time Vision I/O	223

## 8 Industrial Chassis



Selection Guide		227
AX60501	6-slot ShoeBox Chassis	228
<b>NEW</b> AX60810	Wall Mount Chassis for ATX and Micro-ATX Motherboard	229
AX61131TM	1U Cost-effective Rackmount Chassis for ATX Motherboard	231
AX61223TM	2U Rackmount Chassis for ATX Motherboard	233
AX61410	4U 14-slot Rackmount Chassis	235
AX6156LE	COM Express Type 10 Mini Module with Intel® Pentium® Processor N4200 & Celeron® Processor N3350	237



# 1

## Embedded Systems

Axiomtek offers a full range of expandable, high performance and industry-specific embedded systems (eBOX). The eBOX products are designed to offer great versatility for a wide variety of applications. These feature-rich, industrial-grade embedded systems can be tailored to meet different application requirements. The eBOX offers standard features that include powerful computing capabilities, fanless operation, wide operating temperature ranges, low power consumption, superior reliability, flexible I/O configurations, long product life cycles, and long-term support.

Selection Guide	113
eBOX100-312-FL Fanless Embedded System with Intel® Celeron® N3350 2.4 GHz/ Pentium® N4200 2.5 GHz, 2 HDMI, 2 GbE LANs and 6 USB	119
eBOX560-500-FL Fanless Embedded System with Intel® Core™ i7-6600U 3.4 GHz/ i5-6300U 3 GHz/i3-6100U 2.3GHz/Celeron® 3955U 2.0 GHz, 2 HDMI, 2 GbE LANs, 4 USB 3.0, 2 COM and PCI Express Mini Card Slot	120
eBOX560-512-FL Fanless Embedded System with Intel® Core™ i5-7300U 3.5 GHz/ Celeron® 3965U 2.2 GHz, 2 HDMI, 2 GbE LANs, 4 USB 3.0 and PCI Express Mini Card Slot	121
 eBOX560-900-FL Fanless Edge System with NVIDIA® Jetson™ TX2, HDMI 2.0, 2 GbE LANs, and USB 2.0	122
eBOX565-312-FL Fanless Embedded System with Intel® Celeron® processor N3350, 2 HDMI, 4 USB 3.0, 2 COM, 1 GbE and 1-CH PoE	123
eBOX565-500-FL Fanless Embedded System with Intel® Core™ i5-6300U 2.4 GHz/ i3-6100U 2.3 GHz/Celeron® 3955U 2.0 GHz, 2 HDMI, 2 GbE LANs, 4 USB 3.0, 2 COM and 9 to 36 VDC	124
 eBOX625-312-FL Fanless Embedded System with Intel® Celeron® N3350 2.4 GHz/ Pentium® N4200 2.5 GHz, HDMI, VGA, 2 GbE LANs, 6 USB and 3 COM	125
eBOX625-853-FL Fanless Embedded System with Intel® Celeron® N3160 2.24 GHz, VGA/HDMI, 4 COM, 2 GbE LANs, 4 USB, and 2 PCI Express Mini Card Slots	126
eBOX626-853-FL Fanless Embedded System with Intel® Celeron® N3160 2.24 GHz, VGA/HDMI, 4 COM, 2 GbE LANs, 4 USB, 2 PCI Express Mini Card Slots and 9 to 36 VDC	127
 eBOX627-312-FL Fanless Embedded System Intel® Celeron® N3350 2.4 GHz/ Pentium® N4200 2.5 GHz, HDMI, 2 GbE LANs, 6 USB, 4 COM and 9 to 36 VDC	128

<b>NEW</b>	eBOX638-842-FL	Fanless Embedded System with Intel® Celeron® Processor J1900 2.0 GHz, VGA/HDMI, 4 COM, 6 USB, 2 PCI or 2 PCIe Slots and 9 to 36 VDC Input	129
	eBOX640-500-FL	Fanless Embedded System with LGA1151 Socket 6th/7th Gen Intel® Core™ & Celeron® Processor, Intel® H110, 1 HDMI, DisplayPort, VGA, 6 USB, 4 COM, PCI Express Mini Card Slot and 10 to 30 VDC	130
	eBOX670-891-FL	Fanless Embedded System with LGA1151 Socket 6th/7th Gen Intel® Core™ i7/i5/i3 & Celeron® Processor, Intel® Q170, 2 HDMI, 1 DisplayPort, 4 GbE LANs, 6 USB, Dual PCI Express Mini Card Slots and Wide Range DC-in	131
<b>NEW</b>	eBOX671-517-FL	Fanless Embedded System with LGA1151 Socket 7th/6th Gen Intel® Core™ i7/i5/i3 & Celeron® Processor, Intel® Q170, VGA/DVI-D/HDMI, 8-CH PoE, 6 USB and 9 to 36 VDC	132
<b>NEW</b>	eBOX671-521-FL	Fanless Embedded System with LGA1151 8th Gen Intel® Core™ i7/i5/i3 & Celeron® Processor, 4-CH PoE and Optional MXM Graphics Module Supported	133
	eBOX700-891-FL	Fanless Embedded System with LGA1151 Socket 6th/7th Gen Intel® Core™ i7/i5/i3 & Celeron® Processor, Intel® H110, 2 HDMI, 1 DisplayPort, 4 GbE LANs, 6 USB, PCIe x4/PCI Slot and 9 to 36 VDC	134
	eBOX800-841-FL	Rugged IP67-rated Fanless Embedded System with Intel® Atom® Processor E3845 1.91 GHz, VGA, 2 GbE LANs, 2 USB, 2 COM and 9 to 36 VDC	135
<b>NEW</b>	eBOX800-511-FL	Rugged IP67-rated Fanless Embedded System with Intel Core™ i5-7300U/Celeron® 3965U, VGA, GbE LAN, 2 USB, 2 COM and 9 to 36 VDC	136
<b>NEW</b>	eBOX800-900-FL	Rugged IP67-rated Fanless Edge System with NVIDIA® Jetson™ TX2, HDMI, GbE LAN, 1-CH PoE, USB 2.0 and 100 to 240 VAC Power Input	137

# Systems and Platforms

# Embedded Systems

## Selection Guide



Features/Models	eBOX100-312-FL	eBOX560-500-FL	eBOX560-512-FL
<b>CPU Level</b>	Intel® Celeron® N3350 2.4 GHz Intel® Pentium® N4200 2.5 GHz	Intel® Core™ i7-6600U 3.4 GHz/ i5-6300U 3.0 GHz/i3-6100U 2.3 GHz & Celeron® 3955U 2.0 GHz	Intel® Core™ i5-7300U 2.4 GHz & Celeron® 3965U 2.2 GHz
<b>System Memory</b>	1 x 204-pin DDR3L-1600 SO-DIMM, up to 8GB	1 x 260-pin DDR4-2133 SO-DIMM, up to 16GB	1 x 260-pin DDR4-2133 SO-DIMM, up to 16GB
<b>Chipset</b>	SoC integrated	SoC integrated	SoC integrated
<b>Serial</b>	1 x RS-232	1 x RS-232/422/485 1 x RS-232	2 x RS-232/422/485
<b>Display</b>	2 x HDMI	2 x HDMI	2 x HDMI
<b>Audio</b>	N/A	N/A	N/A
<b>PS/2</b>	N/A	N/A	N/A
<b>Ethernet</b>	2 x 10/100/1000 Mbps Ethernet	2 x 10/100/1000 Mbps Ethernet	2 x 10/100/1000 Mbps Ethernet
<b>USB</b>	4 x USB 2.0 2 x USB 3.0	4 x USB 3.0	4 x USB 3.0
<b>Expansion Interface</b>	2 x full-size PCI Express Mini Card slot (USB + PCIe) 1 x SIM slot	1 x full-size PCI Express Mini Card slot (USB + PCIe)	1 x full-size PCI Express Mini Card slot (USB + PCIe)
<b>Storage</b>	1 x 2.5" HDD drive bay	1 x 2.5" HDD drive bay 1 x mSATA (enabled in BIOS setting)	1 x 2.5" HDD drive bay 1 x mSATA (enabled in BIOS setting)
<b>Watchdog Timer</b>	255 levels, 1 to 255 sec.	255 levels, 1 to 255 sec.	255 levels, 1 to 255 sec.
<b>Power Supply</b>	12 VDC	12 VDC	12 VDC
<b>Operating Temperature</b>	-5°C to +60°C (+23°F to +140°F) (with W.T. SSD/DRAM)	-10°C to +55°C (+14°F to +131°F) (with W.T. SSD/DRAM)	-10°C to +50°C (+14°F to +122°F) (with W.T. SSD/DRAM)
<b>Mounting</b>	Wall mount VESA mount DIN-rail	Wall mount VESA mount DIN-rail	Wall mount VESA mount DIN-rail
<b>Dimensions (W x D x H)</b>	216 x 137.65 x 38 mm (8.5" x 5.41" x 1.49")	141.5 x 106 x 55 mm (5.57" x 4.17" x 2.17")	141.6 x 106 x 54.85 mm (5.57" x 4.17" x 2.15")
<b>Weight (net/gross)</b>	1.15 kg (2.53 lb)/1.5 kg (3.3 lb)	0.8 kg (1.76 lb)/1.67 kg (3.68 lb)	0.8 kg (1.76 lb)/1.67 kg (3.68 lb)
<b>Certifications</b>	CE, FCC Class A	CE	CE, FCC Class A
<b>EOS Support</b>	Win 10 IoT, Linux	Win 10 IoT, WE8S, Linux	Win 10 IoT, Linux



Features/Models	eBOX560-900-FL	eBOX565-312-FL	eBOX565-500-FL
<b>CPU Level</b>	NVIDIA® Jetson™ TX2 SoM HMP Dual Denver 2/2 MB L2 + Quad ARM® A57/2 MB L2	Intel® Celeron® N3350 2.4 GHz	Intel® Core™ i5-6300U 2.4 GHz/ i3-6100U 2.3 GHz & Celeron® 3955U 2.0 GHz
<b>System Memory</b>	1 x 8GB 128-bit LPDDR4@1866 MHz onboard	1 x 204-pin DDR3L-1867 SO-DIMM, up to 8GB	1 x 260-pin DDR4-2133 SO-DIMM, up to 16GB
<b>Chipset</b>	SoM integrated	SoC integrated	SoC integrated
<b>Serial</b>	N/A	2 x RS-232/422/485	1 x RS-232/422/485 1 x RS-232
<b>Display</b>	1 x HDMI	2 x HDMI	2 x HDMI
<b>Audio</b>	N/A	N/A	N/A
<b>PS/2</b>	N/A	N/A	N/A
<b>Ethernet</b>	2 x 10/100/1000 Mbps Ethernet (NVIDIA® + Intel® i210-IT)	1 x 10/100/1000 Mbps Ethernet 1 x 10/100/1000 Mbps PoE (15.4W)	2 x 10/100/1000 Mbps Ethernet
<b>USB</b>	1 x USB 2.0	4 x USB 3.0	4 x USB 3.0
<b>Expansion Interface</b>	1 x full-size PCI Express Mini Card slot (USB + PCIe)	1 x full-size PCI Express Mini Card slot (USB + PCIe)	1 x full-size PCI Express Mini Card slot (USB + PCIe)
<b>Storage</b>	Onboard 32GB eMMC (via Jetson™ TX2) 1 x M.2 Key M 2280 with PCIe 2.0 x4 for NVMe SSD (optional)	1 x 2.5" HDD drive bay 1 x mSATA (enabled in BIOS setting)	1 x 2.5" HDD drive bay 1 x mSATA (enabled in BIOS setting)
<b>Watchdog Timer</b>	Built-in TX2	255 levels, 1 to 255 sec.	255 levels, 1 to 255 sec.
<b>Power Supply</b>	12 VDC	12 VDC	9 to 36 VDC
<b>Operating Temperature</b>	-30°C to +60°C (-22°F to +140°F)	-20°C to +55°C (-4°F to +131°F) (with W.T. SSD/DRAM)	-20°C to +50°C (-4°F to +122°F) (with W.T. SSD/DRAM)
<b>Mounting</b>	Wall mount VESA mount DIN-rail	Wall mount VESA mount DIN-rail	Wall mount VESA mount DIN-rail
<b>Dimensions (W x D x H)</b>	141.6 x 106 x 55 mm (5.57" x 4.17" x 2.17")	141.5 x 106 x 78.85 mm (5.57" x 4.17" x 3.10")	141.5 x 106 x 73 mm (5.57" x 4.17" x 2.87")
<b>Weight (net/gross)</b>	0.8 kg (1.76 lb)/1.5 kg (3.31 lb)	1.074 kg (1.76lb)/1.67 kg (3.68lb)	1.074 kg (1.76lb)/1.67 kg (3.68lb)
<b>Certifications</b>	CE, FCC Class A	CE, FCC Class A	CE
<b>EOS Support</b>	Linux Ubuntu 16.04	Win 10 IoT, Linux, AXView 2.0	Win 10 IoT, WE8S, Linux

# Embedded Systems

## Selection Guide

NEW



Features/Models	eBOX625-312-FL	eBOX625-853-FL	eBOX626-853-FL
<b>CPU Level</b>	Intel® Celeron® N3350 2.4 GHz Intel® Pentium® N4200 2.5 GHz	Intel® Celeron® N3160 2.24 GHz	Intel® Celeron® N3160 2.24 GHz
<b>System Memory</b>	1 x 204-pin DDR3L-1866 SO-DIMM, up to 8GB	1 x 204-pin DDR3L-1333/1600 SO-DIMM, up to 8GB	1 x 204-pin DDR3L-1333/1600 SO-DIMM, up to 8GB
<b>Chipset</b>	SoC integrated	SoC integrated	SoC integrated
<b>Serial</b>	2 x RS-232/422/485 1 x RS-232	1 x RS-232/422/485 3 x RS-232	1 x RS-232/422/485 3 x RS-232
<b>Display</b>	1 x HDMI (lockable) 1 x VGA	1 x VGA 1 x HDMI	1 x VGA 1 x HDMI
<b>Audio</b>	Yes	Yes	Yes
<b>PS/2</b>	N/A	N/A	N/A
<b>Ethernet</b>	2 x 10/100/1000 Mbps Ethernet	2 x 10/100/1000 Mbps Ethernet	2 x 10/100/1000Mbps Ethernet
<b>USB</b>	2 x USB 2.0 4 x USB 3.0	1 x USB 2.0 3 x USB 3.0	1 x USB 2.0 3 x USB 3.0
<b>Expansion Interface</b>	2 x full-size PCI Express Mini Card slot (USB + PCIe) 1 x SIM slot	2 x full-size PCI Express Mini Card slot (USB + PCIe) 1 x SIM slot	2 x full-size PCI Express Mini Card slot (USB + PCIe) 1 x SIM slot
<b>Storage</b>	1 x 2.5" HDD drive bay 1 x mSATA (enabled in BIOS setting)	1 x 2.5" HDD drive bay 1 x mSATA (enabled in BIOS setting)	1 x 2.5" HDD drive bay 1 x mSATA (enabled in BIOS setting)
<b>Watchdog Timer</b>	65536 levels, 1 ~ 65535 sec.	255 levels, 1 to 255 sec.	255 levels, 1 to 255 sec.
<b>Power Supply</b>	12 VDC	12 VDC	9 to 36 VDC
<b>Operating Temperature</b>	-20°C to +60°C (-4°F to +140°F) (with W.T. SSD/DRAM)	-20°C to +60°C (-4°F to +140°F) (with W.T. SSD/DRAM)	-20°C to +60°C (-4°F to +140°F) (with W.T. SSD/DRAM)
<b>Mounting</b>	Wall mount VESA mount DIN-rail	Wall mount VESA mount DIN-rail	Wall mount VESA mount DIN-rail
<b>Dimensions (W x D x H)</b>	200 x 120 x 46 mm (7.87" x 4.72" x 1.81")	200 x 120 x 46 mm (7.87" x 4.72" x 1.81")	200 x 120 x 46 mm (7.87" x 4.72" x 1.81")
<b>Weight (net/gross)</b>	1.1 kg (2.43 lb)/1.8 kg (3.97 lb)	1.2 kg (2.65 lb)/1.9 kg (4.19 lb)	1.2 kg (2.65 lb)/1.9 kg (4.19 lb)
<b>Certifications</b>	CE, FCC Class A	CE	CE
<b>EOS Support</b>	Win 10 IoT, Linux ,AXView 2.0	Win 10 IoT, Linux	Win 10 IoT, Linux



NEW



NEW



Features/Models	eBOX627-312-FL	eBOX638-842-FL	eBOX640-500-FL
<b>CPU Level</b>	Intel® Celeron® N3350 2.4 GHz Intel® Pentium® N4200 2.5 GHz	Intel® Celeron® J1900 2.0 GHz	LGA1151 7th/6th gen Intel® Core™ i7/i5/i3 & Celeron®
<b>System Memory</b>	1 x 204-pin DDR3L-1866 SO-DIMM, up to 8GB	1 x 204-pin DDR3L-1066/1333 SO-DIMM, up to 8GB	2 x 288-pin DDR4-2133 DIMM, up to 32GB
<b>Chipset</b>	SoC integrated	SoC integrated	Intel® H110
<b>Serial</b>	2 x RS-232/422/485 2 x RS-232	2 x RS-232/422/485 2 x RS-232	1 x RS-232/422/485 3 x RS-232
<b>Display</b>	1 x HDMI (lockable)	1 x HDMI 1 x VGA	1 x DisplayPort 1 x HDMI 1 x VGA
<b>Audio</b>	N/A	Yes	Yes
<b>PS/2</b>	N/A	Yes	N/A
<b>Ethernet</b>	2 x 10/100/1000 Mbps Ethernet	2 x 10/100/1000 Mbps Ethernet	2 x 10/100/1000 Mbps Ethernet
<b>USB</b>	2 x USB 2.0 4 x USB 3.0	5 x USB 2.0 1 x USB 3.0	2 x USB 2.0 4 x USB 3.0
<b>Expansion Interface</b>	2 x full-size PCI Express Mini Card slot (USB + PCIe) 1 x SIM slot	1 x full-size PCI Express Mini Card slot (USB + PCIe) 2 PCI slot or 2 PCIe x1 slot 1 x SIM slot	1 x full-size PCI Express Mini Card slot (USB + PCIe) 1 x SIM slot
<b>Storage</b>	1 x 2.5" HDD drive bay 1 x mSATA (enabled in BIOS setting)	1 x 2.5" HDD drive bay 1 x mSATA (enabled in BIOS setting)	2 x 2.5" HDD drive bay 1 x mSATA (enabled in BIOS setting)
<b>Watchdog Timer</b>	65536 levels, 1 ~ 65535 sec.	255 levels, 1 to 255 sec.	255 levels, 1 to 255 sec.
<b>Power Supply</b>	9 to 36 VDC	9 to 36 VDC	10 to 30 VDC
<b>Operating Temperature</b>	-20°C to +70°C (-4°F to +158°F) (with W.T. SSD/DRAM)	-10°C to +55°C (14°F to +131°F) (with W.T. DRAM & SSD)	-10°C to +55°C (+14°F to +131°F) (with W.T. SSD/DRAM)
<b>Mounting</b>	Wall mount VESA mount DIN-rail	Wall mount	Wall mount
<b>Dimensions (W x D x H)</b>	200 x 120 x 65 mm (7.87" x 4.72" x 2.55")	19 x 230 x 115.8 mm (7.56" x 9.05" x 4.56")	182 x 235.7 x 82 mm (7.16" x 9.27" x 3.23")
<b>Weight (net/gross)</b>	1.38 kg (3.04 lb)/2.08 kg (4.59 lb)	4.1 kg (9.03 lb) /4.8 kg (10.58 lb)	3 kg (6.61 lb)/3.6 kg (7.94 lb)
<b>Certifications</b>	CE, FCC Class A	CE	CE
<b>EOS Support</b>	Win 10 IoT, Linux, AXView 2.0	WES7, Win 10 IoT	Win 10 IoT, WE8S, WES7, Linux

# Embedded Systems

## Selection Guide



Features/Models	eBOX670-891-FL	eBOX671-517-FL	eBOX671-521-FL	eBOX700-891-FL
<b>CPU Level</b>	LGA1151 7th/6th gen Intel® Core™ i7/i5/i3 & Celeron®	LGA1151 socket 7th/6th gen Intel® Core™ i7/i5/i3 & Celeron® (35W/65W)	LGA1151 8th gen Intel® Core™ i7/i5/i3 & Celeron® (35W/65W)	LGA1151 7th/6th gen Intel® Core™ i7/i5/i3 & Celeron®
<b>System Memory</b>	2 x 260-pin DDR4-2133 SO-DIMM, up to 32GB	2 x 260-pin DDR4-2133 SO-DIMM, up to 32GB	2 x 260-pin DDR4-2666 SO-DIMM, up to 32GB	2 x 260-pin DDR4-2133 SO-DIMM, up to 32GB
<b>Chipset</b>	Intel® Q170	Intel® Q170	Intel® Q370 Intel® C246 (optional)	Intel® H110
<b>Serial</b>	2 x RS-232/422/485	2 x RS-232/422/485	2 x RS-232/422/485	2 x RS-232/422/485
<b>Display</b>	1 x DisplayPort 2 x HDMI	1 x VGA 1 x DVI-D 1 x HDMI	1 x DisplayPort 1 x DVI-I 1 x HDMI 2 x DisplayPort via MXM (optional)	1 x DisplayPort 2 x HDMI
<b>Audio</b>	Yes	Yes	Optional	Yes
<b>PS/2</b>	N/A	N/A	N/A	N/A
<b>Ethernet</b>	4 x 10/100/1000 Mbps Ethernet	8 x 10/100/1000 Mbps PoE, max. up to 120W	2 x 10/100/1000 Mbps Ethernet 4 x 10/100/1000 Mbps PoE, max. up to 60W	4 x 10/100/1000 Mbps Ethernet
<b>USB</b>	2 x USB 2.0 4 x USB 3.0	2 x USB 2.0 4 x USB 3.0	4 x USB 3.1 Gen1 2 x USB 3.1 Gen2	2 x USB 2.0 4 x USB 3.0
<b>Expansion Interface</b>	2 x full-size PCI Express Mini Card slot (USB + PCIe) 1 x SIM slot	2 x full-size PCI Express Mini Card slot (USB + PCIe) 1 x half-size PCI Express Mini Card slot (USB only) 1 x half-size PCI Express Mini Card slot (USB + mSATA) 2 x SIM slot	1 x full-size PCI Express Mini Card slot (USB + PCIe) 1 x full-size PCI Express Mini Card slot (USB + PCIe + mSATA) 2 x SIM slot	2 x full-size PCI Express Mini Card slot (USB + PCIe) 1 x PCIe x4 or 1 x PCI 1 x SIM slot
<b>Storage</b>	2 x 2.5" HDD drive bay 1 x mSATA (enabled in BIOS setting)	1 x 2.5" HDD drive bay 1 x mSATA (enabled in BIOS setting)	2 x 2.5" HDD drive bay 1 x mSATA (enabled in BIOS setting)	1 x 2.5" HDD drive bay 1 x mSATA (enabled in BIOS setting)
<b>Watchdog Timer</b>	255 levels, 1 to 255 sec.	255 levels, 1 to 255 sec.	255 levels, 1 to 255 sec.	255 levels, 1 to 255 sec.
<b>Power Supply</b>	9 to 36 VDC	9 to 36 VDC	24 VDC	9 to 36 VDC
<b>Operating Temperature</b>	-40°C to +60°C (-40°F to +140° F) (with W.T. SSD/DRAM)	-40°C to +60°C (-40°F to +140° F) (with W.T. SSD/DRAM)	-20°C to +60°C (-4°F to +140°F) (with W.T. SSD/DRAM)	-40°C to +50°C (-40°F to +122° F) (with W.T. SSD/DRAM)
<b>Mounting</b>	Wall mount DIN-rail	Wall mount DIN-rail	Wall mount DIN-rail	Wall mount DIN-rail
<b>Dimensions (W x D x H)</b>	280 x 190 x 76 mm (11.02" x 7.4" x 2.99" )	280 x 210 x 79.6 mm (11.02" x 8.26" x 3.13")	280 x 210 x 80.5 mm (11.02" x 8.26" x 3.16")	280 x 190 x 76 mm (11.02" x 7.4" x 2.99" )
<b>Weight (net/gross)</b>	3.8 kg (8.37 lb)/4.6 kg (10.14 lb)	3.8 kg (8.37 lb)/4.6 kg (10.14 lb)	4.8 kg (10.58 lb)/5.6 kg (12.34 lb)	3.8 kg (8.37 lb)/4.6 kg (10.14 lb)
<b>Certifications</b>	CE, FCC Class A	CE, FCC Class A	CE, FCC Class A	CE, FCC Class A
<b>EOS Support</b>	Win 10 IoT, Linux, AXView 2.0	Win 10 IoT, Linux, AXView 2.0	Win 10 IoT, Linux, AXView 2.0	Win 10 IoT, Linux , AXView 2.0



Features/Models	eBOX800-841-FL	eBOX800-511-FL	eBOX800-900-FL
<b>CPU Level</b>	Intel® Atom® E3845 1.91 GHz	Intel® Core™ i5-7300U & Celeron® 3965U	HMP dual denver 2/2 MB L2 + quad ARMv A57/2 MB L2
<b>System Memory</b>	1 x 204-pin DDR3L-1066/1333 SO-DIMM, up to 8GB	1 x 260-pin DDR4-2133 SO-DIMM, up to 16GB	1 x 8GB 128-bit LPDDR4 @1866 MHz onboard
<b>Chipset</b>	SoC integrated	SoC integrated	SoM integrated
<b>Serial</b>	2 x RS-232/422/485 (M12)	2 x RS-232/422/485 (M12)	N/A
<b>Display</b>	1 x VGA	1 x VGA (M12)	1 x C3 HDMI (M12)
<b>Audio</b>	N/A	N/A	N/A
<b>PS/2</b>	N/A	N/A	N/A
<b>Ethernet</b>	2 x 10/100/1000 Mbps Ethernet (M12)	1 x 10/100/1000 Mbps Ethernet (M12)	1 x 10/100/1000 Mbps Ethernet (M12) 1 x 10/100/1000 Mbps PoE (M12,30W)
<b>USB</b>	2 x USB 2.0 (M12)	2 x USB 2.0 (M12)	1 x USB 2.0 (M12)
<b>Expansion Interface</b>	1 x full-size PCI Express Mini Card slot 1 x half-size PCI Express Mini Card slot (USB + PCIe)	1 x full-size PCI Express Mini Card slot 1 x half-size PCI Express Mini Card slot (USB + PCIe)	1 x full-size PCI Express Mini Card slot (USB + PCI Express signal)
<b>Storage</b>	1 x 2.5" HDD drive bay 1 x CFast™ 1 x mSATA (enabled in BIOS setting)	1 x 2.5" HDD drive bay 1 x mSATA (enabled in BIOS setting)	Onboard 32GB eMMC (via Jetson™ TX2) 1 x M.2 Key M 2280 with PCIe 2.0 x4 for NVMe SSD (optional)
<b>Watchdog Timer</b>	255 levels, 1 to 255 sec.	255 levels, 1 to 255 sec.	Built-in TX2
<b>Power Supply</b>	9 to 36 VDC (M12)	9 to 36 VDC (M12)	100 to 240 VAC with 10kV SPD
<b>Operating Temperature</b>	-30°C to +60°C (-22°F to +140°F) (with W.T. SSD/DRAM)	-30°C to +60°C (-22°F to +140°F) (with i5-7300U, W.T. SSD/DRAM)	-30°C to +60°C (-22°F to +140°F)
<b>Mounting</b>	Wall mount	Wall mount	Wall mount
<b>Dimensions (W x D x H)</b>	210 x 366.83 x 83 mm (8.27" x 14.44" x 3.27")	210 x 366.83 x 83 mm (8.27" x 14.44" x 3.27")	210 x 366.83 x 83 mm (8.27" x 14.44" x 3.27")
<b>Weight (net/gross)</b>	4.31 kg (9.5 lb)/5.1 kg (11.24 lb)	4.31 kg (9.5 lb)/5.1 kg (11.24 lb)	4.31 kg (9.5 lb)/5.1 kg (11.24 lb)
<b>Certifications</b>	CE	CE, FCC Class A	CE, FCC Class A
<b>EOS Support</b>	Win 10 IoT, WE8S, WES7, Linux	Win 10 IoT, Linux, AXView 2.0	Linux Ubuntu 16.04

# eBOX100-312-FL

Fanless Embedded System with Intel® Celeron® N3350 & Pentium® N4200, 2 HDMI, 2 GbE LANs and 6 USB

## Features

- Intel® Celeron® N3350 2.4 GHz & Pentium® N4200 2.5 GHz
- Supports 2 HDMI, 1 COM, 6 USB and 2 GbE LANs
- 2 PCI Express Mini Card slots for WLAN and WWAN
- One swappable 2.5" SATA HDD drive bay
- Supports Jumbo Frame (9k), WoL, PXE Remote Boot
- Suitable for smart retail and light industries

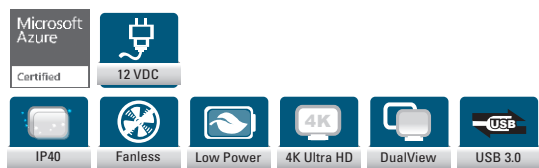

## Specifications

Standard Color	Silver
Construction	Aluminum extrusion and heavy-duty steel, IP40
CPU	Intel® Celeron® N3350 2.4 GHz with turbo boost Intel® Pentium® N4200 2.5 GHz with turbo boost
System Memory	1 x 204-pin DDR3L-1600 SO-DIMM, up to 8GB
Chipset	SoC integrated
BIOS	AMI UEFI BIOS
System I/O Outlet	1 x RS-232 2 x HDMI 1.4b 2 x 10/100/1000 Mbps Ethernet (Intel® i211-AT) 2 x USB 3.0 4 x USB 2.0 4 x Antenna opening 1 x ATX power switch 1 x ATX/AT quick switch 1 x Reset button 1 x Remote power switch 1 x Screw type VDC power input connector
Watchdog Timer	255 levels, 1 to 255 sec.
Storage	1 x SATA HDD drive bay (max. up 9.5 mm height)
Expansion Interface	2 x Full-size PCI Express Mini Card slot (USB + PCIe) 1 x SIM slot
TPM	N/A
System Indicator	1 x green LED for system power-on 1 x orange LED for HDD active
Power Input	12 VDC
Operating Temperature	-5°C to +60°C (+23°F to +140°F) (with W.T. DRAM & SSD)
Storage Temperature	-20°C to +85°C (-4°F to +185°F)
Humidity	10% to 90%, non-condensing
Vibration Endurance	3 Grms with SSD (5 to 500 Hz, X, Y, Z directions)
Dimensions	216 mm (8.5") x 137.65 mm (5.41") x 38 mm (1.49")
Weight (net/gross)	1.15 kg (2.53 lb)/1.5 kg (3.3 lb)
Certifications	CE, FCC Class A
EOS Support	Win 10 IoT, Linux

\* W.T.: Wide Temperature. All W.T. supported products have to be sorted by Axiomtek.

## Packing List

- 1 x Quick manual
- 1 x Driver CD
- 1 x Screw pack
- 4 x Pre-installed foot pad
- 1 x HDD rubber
- 1 x Remote switch cable
- 1 x US power cord or 1 x EU power cord
- 1 x 12V/36W power adapter

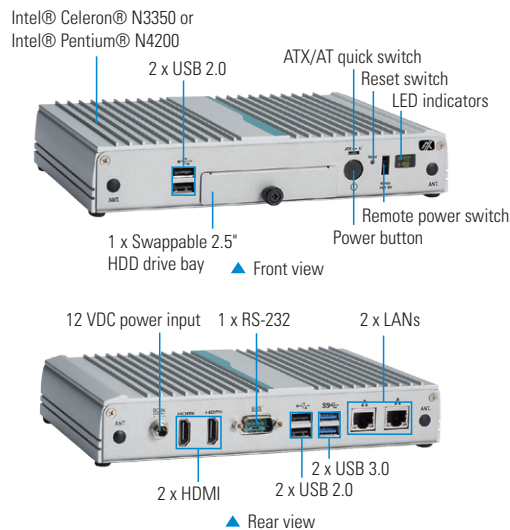

## Power Protection

### AC Version

- OVP (over voltage protection)
- OCV (over current protection)
- SCP (short circuit protection)

## Ordering Information

### Standard

eBOX100-312-FL-N3350-US	Fanless embedded system with Intel® Celeron® N3350 2.4 GHz, 2 HDMI, 2 GbE LANs, 6 USB, 12V/36W power adapter and US power cord
eBOX100-310-FL-N3350-EU	Fanless embedded system with Intel® Celeron® N3350 2.4 GHz, 2 HDMI, 2 GbE LANs, 6 USB, 12V/36W power adapter and EU power cord
eBOX100-312-FL-N4200-US	Fanless embedded system with Intel® Pentium® N4200 2.5 GHz, 2 HDMI, 2 GbE LANs, 6 USB, 12V/36W power adapter and US power cord
eBOX100-312-FL-N4200-EU	Fanless embedded system with Intel® Pentium® N4200 2.5 GHz, 2 HDMI, 2 GbE LANs, 6 USB, 12V/36W power adapter and EU power cord

### Optional

2.5" SATA HDD	64GB or above
2.5" SATA SSD	100GB or above
DDR3L SO-DIMM	2GB to 8GB
88606200010E	Wall mount kit
8816K1000A0E	VESA mount kit
881606470A0E	DIN-rail kit
8816K1001A0E	Wi-Fi module
	3G/LTE module

\* Specifications and certifications may vary based on different requirements.

## Dimensions

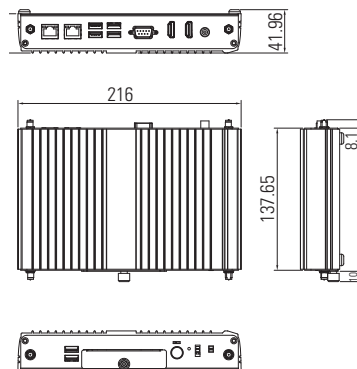

# eBOX560-500-FL

Fanless Embedded System with Intel® Core™ i7-6600U/i5-6300U/i3-6100U & Celeron® 3955U, 2 HDMI, 2 GbE LANs, 4 USB 3.0, 2 COM and PCI Express Mini Card Slot

## Features

- Intel® Core™ i7-6600U 3.4 GHz/i5-6300U 3 GHz/i3-6100U 2.3 GHz & Celeron® 3955U 2.0 GHz (Skylake ULT SoC)
- 260-pin DDR4 SO-DIMM for up to 16GB of memory
- 12 VDC power input
- Supports 2 HDMI, 2 GbE LANs, 2 COM and 4 USB 3.0
- Supports Jumbo Frame (9.5K), WoL, PXE and Teaming
- Ultra-compact enclosure design



## Specifications

Standard Color	Silver-black
Construction	Aluminum extrusion and heavy-duty steel, IP40
CPU	Intel® Core™ i7-6600U 3.4 GHz/i5-6300U 3 GHz/i3-6100U 2.3 GHz & Celeron® 3955U 2.0 GHz (Skylake ULT SoC)
System Memory	1 x 260-pin DDR4-2133 SO-DIMM, up to 16GB
Chipset	SoC integrated
BIOS	AMI
System I/O Outlet	1 x RS-232/422/485 1 x RS-232 2 x HDMI 2 x 10/100/1000 Mbps Ethernet (Intel® i210-AT, i219-LM) 4 x USB 3.0 2 x SMA-type antenna connector 1 x AT/ATX quick switch 1 x ATX power switch 1 x Reset button 1 x Screw type VDC power input connector
Watchdog Timer	255 levels, 1 to 255 sec.
Storage	1 x 2.5" SATA HDD drive bay (max. up 9.5 mm height) 1 x mSATA (enabled in BIOS setting)
Expansion Interface	1 x Full-size PCI Express Mini Card slot (USB + PCI Express signal)
TPM	N/A
System Indicator	1 x green LED for system power-on 1 x orange LED for HDD active
Power Input	12 VDC
Operating Temperature	-10°C to +55°C (-14°F to +131°F) (with W.T. DRAM/SSD)
Humidity	10% to 95%, non-condensing
Vibration Endurance	3 Grms with SSD™ (5 to 500 Hz, X, Y, Z directions)
Dimensions	141.5 mm (5.57") (W) x 106 mm (4.17") (D) x 55 mm (2.17") (H)
Weight (net/gross)	0.8 kg (1.76 lb)/1.67 kg (3.68 lb)
Certifications	CE
EOS Support	Win 10, WE8S, Linux

\* W.T.: Wide Temperature. All W.T. supported products have to be sorted by Axiomtek.

## Packing List

- 1 x Quick manual
- 1 x Driver CD
- 1 x Screw pack
- 1 x 12 VDC/60W AC to DC adapter
- 1 x EU power cord or 1 x US power cord
- 4 x Pre-installed foot pad

## Power Protection

### AC Version

- OVP (over voltage protection)
- OCP (over current protection)
- SCP (short circuit protection)
- Reverse protection



## Ordering Information

Standard	
eBOX560-500-FL-3955U-US	Fanless embedded system with Intel® Celeron® 3955U, 2 HDMI, 2 GbE LANs, 4 USB 3.0, 2 COM, PCI Express Mini Card slot, 12V 60W power adaptor and US power cord
eBOX560-500-FL-3955U-EU	Fanless embedded system with Intel® Celeron® 3955U, 2 HDMI, 2 GbE LANs, 4 USB 3.0, 2 COM, PCI Express Mini Card slot, 12V 60W power adaptor and EU power cord
eBOX560-500-FL-6600U-US	Fanless embedded system with Intel® Core™ i7-6600U, 2 HDMI, 2 GbE LANs, 4 USB 3.0, 2 COM, PCI Express Mini Card slot, 12V 60W power adaptor and US power cord
eBOX560-500-FL-6600U-EU	Fanless embedded system with Intel® Core™ i7-6600U, 2 HDMI, 2 GbE LANs, 4 USB 3.0, 2 COM, PCI Express Mini Card slot, 12V 60W power adaptor and EU power cord
eBOX560-500-FL-6300U-US	Fanless embedded system with Intel® Core™ i5-6300U, 2 HDMI, 2 GbE LANs, 4 USB 3.0, 2 COM, PCI Express Mini Card slot, 12V 60W power adaptor and US power cord
eBOX560-500-FL-6300U-EU	Fanless embedded system with Intel® Core™ i5-6300U, 2 HDMI, 2 GbE LANs, 4 USB 3.0, 2 COM, PCI Express Mini Card slot, 12V 60W power adaptor and EU power cord
eBOX560-500-FL-6100U-US	Fanless embedded system with Intel® Core™ i3-6100U, 2 HDMI, 2 GbE LANs, 4 USB 3.0, 2 COM, PCI Express Mini Card slot, 12V 60W power adaptor and US power cord
eBOX560-500-FL-6100U-EU	Fanless embedded system with Intel® Core™ i3-6100U, 2 HDMI, 2 GbE LANs, 4 USB 3.0, 2 COM, PCI Express Mini Card slot, 12V 60W power adaptor and EU power cord
Optional	
2.5" SATA HDD	64GB or above
2.5" SATA SSD	100GB or above
DDR4 SO-DIMM	2GB to 16GB
826K5601050E	Wall mount kit
8816K560AA0E	VESA arm kit
8816K560BA0E	DIN-rail kit
8816K5603A0E	Wi-Fi module

\* Specifications and certifications may vary based on different requirements.

## Dimensions

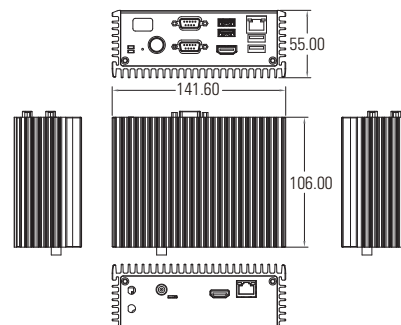



# eBOX560-512-FL

Fanless Embedded System with Intel® Core™ i5-7300U & Celeron® 3965U, 2 HDMI, 2 GbE LANs, 4 USB 3.0 and PCI Express Mini Card Slot

## Features

- Intel® Core™ i5-7300U 3.5 GHz & Celeron® 3965U 2.2 GHz
- Supports 2 COM, 2 GbE LAN and 4 USB 3.0
- One swappable 2.5" HDD drive bay
- 2 HDMI with dual-view supported
- AXView 2.0 intelligent remote monitoring software for IIoT
- Ultra-compact enclosure design
- Trusted Platform Module 1.2 (TPM) 1.2

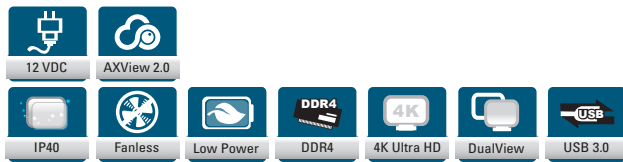

## Specifications

Standard Color	Silver
Construction	Aluminum extrusion and heavy-duty steel, IP40
CPU	Intel® Core™ i5-7300U 3.5 GHz/Celeron® 3965U 2.2 GHz
System Memory	1 x 260-pin DDR4-2133 SO-DIMM, up to 16GB
Chipset	SoC integrated
BIOS	AMI UEFI BIOS
System I/O Outlet	2 x RS-232/422/485 2 x HDMI 2 x 10/100/1000 Mbps Ethernet (Intel® i210-AT, i219-LM) 4 x USB 3.0 2 x SMA-type antenna connector 1 x AT/ATX quick switch 1 x ATX power switch 1 x Reset button 1 x Screw type VDC power input connector
Watchdog Timer	255 levels, 1 to 255 sec.
Storage	1 x 2.5" SATA HDD drive bay (max. up 9.5 mm height) 1 x mSATA (enabled in BIOS setting)
Expansion Interface	1 x Full-size PCI Express Mini Card slot (USB + PCI Express signal)
TPM	TPM 1.2
System Indicator	1 x green LED for system power-on 1 x yellow LED for HDD active
Power Input	12 VDC
Operating Temperature	-10°C to +50°C (+14°F to +122°F) (with W.T. DRAM/SSD)
Humidity	10% to 90%, non-condensing
Vibration Endurance	3 Grms with SSD (5 to 500 Hz, X, Y, Z directions)
Dimensions	141.6 mm (5.57") (W) x 106 mm (4.17") (D) x 54.85 mm (2.15") (H)
Weight (net/gross)	0.8 kg (1.76 lb)/1.67 kg (3.68 lb)
Certifications	CE, FCC Class A
EOS Support	Win 10 IoT, Linux, AXView 2.0

\* W.T.: Wide Temperature. All W.T. supported products have to be sorted by Axiomtek.

## Packing List

- 1 x Quick manual
- 1 x Driver CD
- 1 x Screws pack
- 4 x Pre-installed foot pad
- 1 x 12VDC/60W AC to DC adapter
- 1 x EU power cord or 1 x US power cord

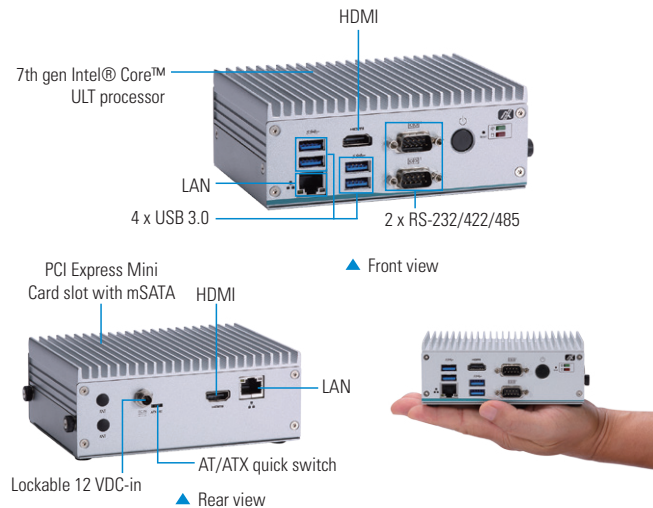

## Power Protection

### AC Version

- OVP (over voltage protection)
- OCV (over current protection)
- SCP (short circuit protection)

## Ordering Information

### Standard

eBOX560-512-7300U-US	Fanless embedded system with Intel® Core™ i5-7300U 3.5 GHz, 2 HDMI, 2 GbE LANs, 4 USB 3.0, PCI Express Mini Card slot and US power cord
eBOX560-512-7300U-EU	Fanless embedded system with Intel® Core™ i5-7300U 3.5 GHz, 2 HDMI, 2 GbE LANs, 4 USB 3.0, PCI Express Mini Card slot and EU power cord
eBOX560-512-3965U-US	Fanless embedded system with Intel® Celeron® 3965U 2.2 GHz, 2 HDMI, 2 GbE LANs, 4 USB 3.0, PCI Express Mini Card slot and US power cord
eBOX560-512-3965U-EU	Fanless embedded system with Intel® Celeron® 3965U 2.2 GHz, 2 HDMI, 2 GbE LANs, 4 USB 3.0, PCI Express Mini Card slot and EU power cord

### Optional

2.5" SATA HDD	64GB or above
2.5" SATA SSD	100GB or above
DDR4 SO-DIMM	2GB to 16GB
826K5601050E	Wall mount kit
8816K560AA0E	VESA arm kit
8816K560BA0E	DIN-rail kit
8816K5603A0E	Wi-Fi module

\* Specifications and certifications may vary based on different requirements.

## Dimensions

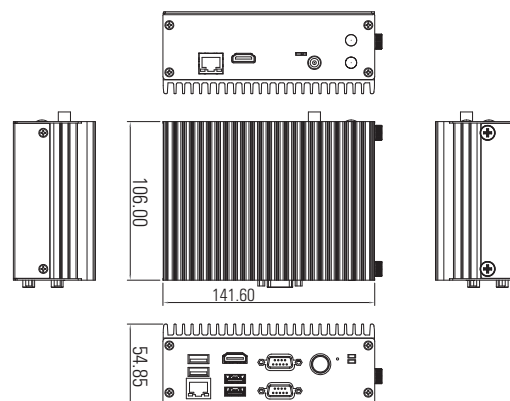

# eBOX560-900-FL NEW

Fanless Edge System with NVIDIA® Jetson™ TX2, HDMI 2.0, 2 GbE LANs, and USB 2.0

## Features

- NVIDIA® Jetson™ TX2 with Pascal™, 256 CUDA cores GPU
- High AI computing performance for GPU-accelerated processing
- Ideal for intelligent edge applications
- Supports M.2. NVMe SSD
- JetPack support
- Ultra-compact enclosure design

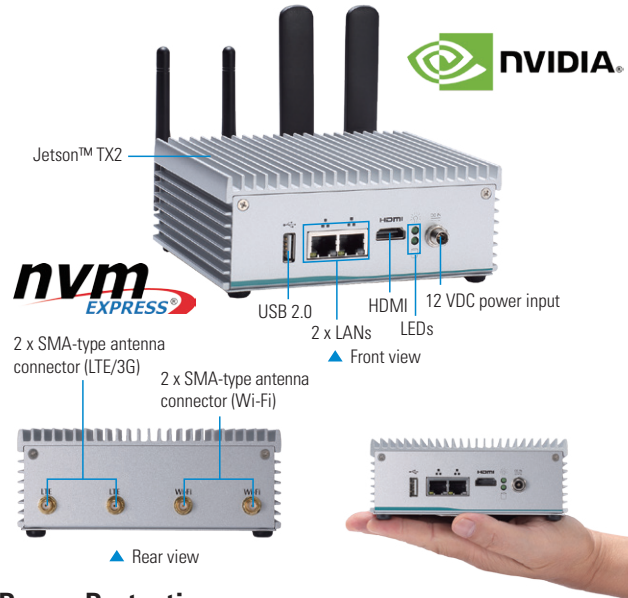

NVIDIA TX2 available through to 2022\*

The official end of life notice will be sent for at least 8 months before the last shipment.



## Specifications

Standard Color	Silver
Construction	Aluminum extrusion and heavy-duty steel, IP40
CPU Board	NVIDIA® Jetson™ TX2
CPU	HMP Dual Denver 2/2 MB L2 + Quad ARM® A57/2 MB L2
GPU	NVIDIA® Pascal™, 256 CUDA cores
System Memory	1 x 8GB 128-bit LPDDR4@1866 MHz onboard
Carried Board	SBC87900
System I/O Outlet	1 x HDMI 2.0 with 4K2K supported 2 x 10/100/1000 Mbps Ethernet (NVIDIA® + Intel® i210-IT) 1 x USB 2.0 1 x 12 VDC power input connector 4 x SMA-type antenna connector
Watchdog Timer	Built-in TX2
Storage	Onboard 32GB eMMC (via Jetson™ TX2) 1 x M.2 Key M 2280 with PCIe x4 Gen2 for NVMe SSD (optional)
Wireless Module	802.11ac WLAN, Bluetooth onboard with N Jack type antennas
Expansion Interface	1 x Full-size PCI Express Mini Card slot (USB + PCI Express signal) *Either Mini PCIe connector or LAN Intel® i210-IT (Jumper Select) 1 x SIM slot
TPM	N/A
System Indicator	1 x green LED for system power-on 1 x green LED for storage
Power Supply	12 VDC screw type
Operating Temperature	-30°C to +60°C (-22°F to +140°F)
Humidity	10% to 95%, non-condensing
Vibration Endurance	3 Grms with M.2 (5 to 500Hz, X, Y, Z directions)
Dimensions	141.6 mm (5.57") (W) x 106 mm (4.17") (D) x 55 mm (2.17") (H)
Weight (net/gross)	0.8 kg (1.76 lb)/1.5 kg (3.31 lb)
Certifications	CE, FCC Class A
OS Support	Linux Ubuntu 16.04

## Packing List

- 1 x Quick manual
- 1 x Screws pack
- 1 x 12V/60W power adapter
- 2 x Wi-Fi antennas
- 1 x EU power cord or 1 x US power cord

## Power Protection

### AC Version

- OVP (over voltage protection)
- OCV (over current protection)
- SCP (short circuit protection)
- UVP (under voltage protection)

## Ordering Information

### Standard

eBOX560-900-FL-US	Fanless Edge System with NVIDIA® Jetson™ TX2, HDMI 2.0, 2 GbE LANs, USB 2.0, 12V/60W power adapter and US power cord
eBOX560-900-FL-EU	Fanless Edge System with NVIDIA® Jetson™ TX2, HDMI 2.0, 2 GbE LANs, USB 2.0, 12V/60W power adapter and EU power cord

### Optional

826K5601050E	Wall mount kit
8816K560AA0E	VESA arm kit
8816K560BA0E	DIN-rail kit kit
M.2 NVMe	64GB or above LTE module

\* Specifications and certifications may vary based on different requirements.

## Dimensions

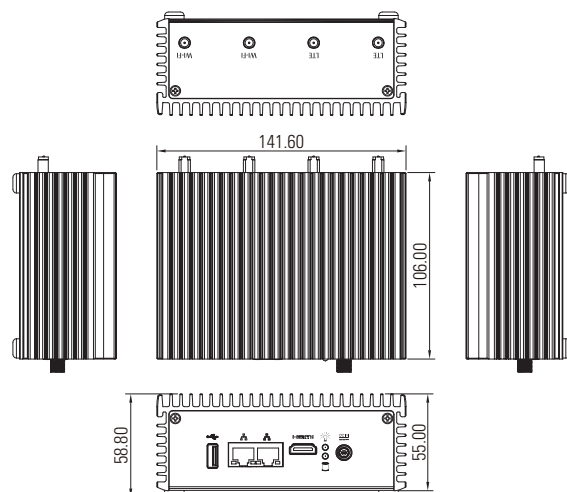

# eBOX565-312-FL

Fanless Embedded System with Intel® Celeron® Processor N3350, 2 HDMI, 4 USB 3.0, 2 COM, 1 GbE LAN and 1-CH PoE

## Features

- Intel® Celeron® processor N3350
- 204-pin DDR3L-1867 SO-DIMM for up to 8GB of memory
- Supports 1-CH PoE, IEEE802.3af
- Supports 2 HDMI, 2 COM and 4 USB 3.0
- One swappable 2.5" SATA HDD drive bay
- AXView 2.0 intelligent remote monitoring software for IIoT
- Ultra-compact enclosure design
- Trusted Platform Module 1.2 (TPM) 1.2



## Specifications

Standard Color	Silver
Construction	Aluminum extrusion and heavy-duty steel, IP40
CPU	Intel® Celeron® processor N3350
System Memory	1 x 204-pin DDR3L-1867 SO-DIMM, up to 8GB
Chipset	SoC integrated
BIOS	AMI
System I/O Outlet	2 x RS-232/422/485 2 x HDMI 1 x 10/100/1000 Mbps Ethernet (Intel® i211-AT) 1 x Gigabit PoE (IEEE 802.3af) port (Intel® i210-AT, 15.4W) 4 x USB 3.0 2 x SMA-type antenna connector 1 x ATX/ATX quick switch 1 x ATX power switch 1 x Reset button 1 x 12 VDC screw type power input connector
Watchdog Timer	255 levels, 1 to 255 sec.
Storage	1 x 2.5" SATA HDD drive bay (max. up 9.5 mm height) 1 x mSATA (enabled in BIOS setting)
Expansion Interface	1 x Full-size PCI Express Mini Card slot (USB + PCI Express signal)
TPM	TPM 1.2
System Indicator	1 x green LED for system power-on 1 x yellow LED for HDD active
Power Supply	Input AC 100 to 240V, AC 60W adapter with lock Output: DC 12V @ 5A
Operating Temperature	-20°C to +55°C (-4°F to +131°F) (with W.T. DRAM/SSD)
Humidity	10% to 95%, non-condensing
Vibration Endurance	3 Grms with SSD™ (5 to 500Hz, X, Y, Z directions)
Dimensions	141.6 mm (5.57") (W) x 106 mm (4.17") (D) x 78.85 mm (3.10") (H)
Weight (net/gross)	1.074 kg (1.76lb)/1.67 kg (3.68lb)
Certifications	CE, FCC Class A
EOS Support	Win 10 IoT, Linux, AXView 2.0

\* W.T.: Wide Temperature. All W.T. supported products have to be sorted by Axiomtek.

## Packing List

### DC Version

- 1 x Quick manual
- 1 x Driver CD
- 1 x Screw pack
- 4 x Foot pad
- 1 x 12V/60W power adapter
- 1 x EU power cord or 1 x US power cord

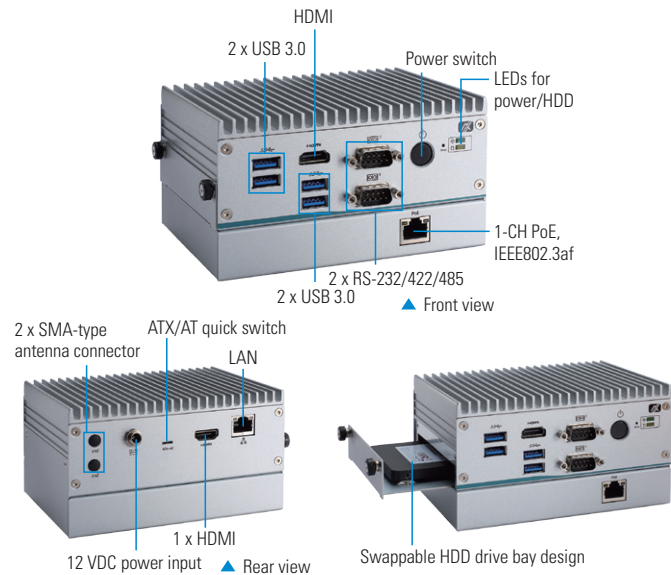

## Power Protection

- OVP (over voltage protection)
- OCV (over current protection)
- SCP (short circuit protection)
- Reverse protection

## Ordering Information

### Standard

eBOX565-312-N3350-POE-US	Fanless embedded system with Intel® Celeron® N3350, 2 HDMI, 1 GbE LAN, 1-CH PoE, 4 USB 3.0, 2 COM, PCI Express Mini Card slot, 12V 60W power adapter and US power cord
eBOX565-312-N3350-POE-EU	Fanless embedded system with Intel® Celeron® N3350, 2 HDMI, 1 GbE LAN, 1-CH PoE, 4 USB 3.0, 2 COM, PCI Express Mini Card slot, 12V 60W power adapter and EU power cord

### Optional

2.5" SATA HDD	64GB or above
2.5" SATA SSD	100GB or above
DDR3L SO-DIMM	2GB to 8GB
826K5601050E	Wall mount kit
8816K560AA0E	VESA arm kit
8816K560BA0E	DIN-rail kit
8816K5603A0E	Wi-Fi module

\* Specifications and certifications may vary based on different requirements.

## Dimensions

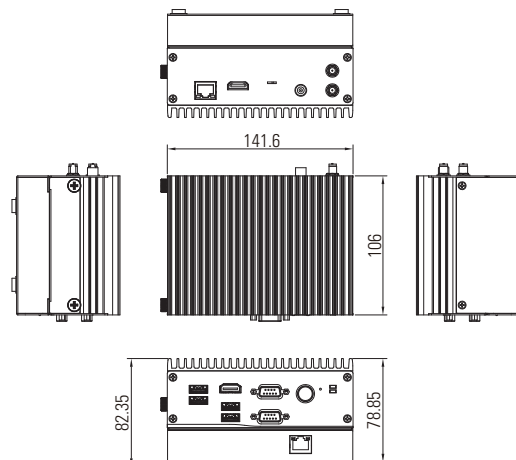

# eBOX565-500-FL

Fanless Embedded System with Intel® Core™ i5-6300U/i3-6100U & Celeron® 3955U, 2 HDMI, 2 GbE LANs, 4 USB 3.0, 2 COM and 9 to 36 VDC

## Features

- Intel® Core™ i5-6300U 2.4 GHz/i3-6100U 2.3 GHz & Celeron® 3955U 2.0 GHz (Skylake ULT SoC)
- 260-pin DDR4-2133 SO-DIMM for up to 16GB of memory
- 9 to 36 VDC wide range input
- Supports 2 HDMI, 2 COM and 4 USB 3.0
- Supports Jumbo Frame (9.5K), WoL, PXE and Teaming
- Ultra-compact enclosure design



## Specifications

Standard Color	Silver-black
Construction	Aluminum extrusion and heavy-duty steel, IP40
CPU	Intel® Core™ i5-6300U 2.4 GHz/i3-6100U 2.3 GHz & Celeron® 3955U 2.0 GHz (Skylake ULT SoC)
System Memory	1 x 260-pin DDR4-2133 SO-DIMM, up to 16GB
Chipset	SoC integrated
BIOS	AMI
System I/O Outlet	1 x RS-232/422/485 1 x RS-232 2 x HDMI 2 x 10/100/1000 Mbps Ethernet (Intel® i210-AT, i219-LM) 4 x USB 3.0 2 x SMA-type antenna connector 1 x AT/ATX quick switch 1 x ATX power switch 1 x Reset button 1 x Phoenix type VDC power input connector
Watchdog Timer	255 levels, 1 to 255 sec.
Storage	1 x 2.5" SATA HDD drive bay (max. up 9.5 mm height) 1 x mSATA (enabled in BIOS setting)
Expansion Interface	1 x Full-size PCI Express Mini Card slot (USB + PCI Express signal)
TPM	N/A
System Indicator	1 x green LED for system power-on 1 x orange LED for HDD active
Power Input	9 to 36 VDC
Operating Temperature	-10°C to +50°C (+14°F to +122°F) (with W.T. SSD)
Humidity	10% to 95%, non-condensing
Vibration Endurance	3 Grms with SSD™ (5 to 500Hz, X, Y, Z directions)
Dimensions	141.6 mm (5.57") (W) x 106 (4.17") mm (D) x 73 mm (2.87") (H)
Weight (net/gross)	1.074 kg (1.76lb)/1.67 kg (3.68lb)
Certifications	CE
EOS Support	Win 10 IoT, WE8S, Linux

\* W.T.: Wide Temperature. All W.T. supported products have to be sorted by Axiomtek.

## Packing List

### DC Version

- 1 x Quick manual
- 1 x Driver CD
- 1 x Screws pack
- 4 x Pre-installed foot pad
- 1 x 2-pin terminal block connector

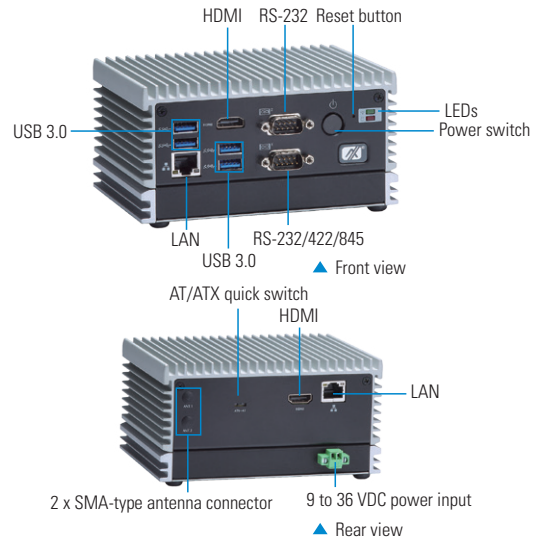

## Power Protection

- OVP (over voltage protection)
- OCP (over current protection)
- SCP (short circuit protection)
- Reverse protection

## Ordering Information

### Standard

eBOX565-500-FL-DC-6300U	Fanless embedded system with Intel® Core™ i5-6300U, 2 HDMI, 2 GbE LANs, 4 USB 3.0, 2 COM, PCI Express Mini Card slot and 9 to 36 VDC
eBOX565-500-FL-DC-6100U	Fanless embedded system with Intel® Core™ i3-6100U, 2 HDMI, 2 GbE LANs, 4 USB 3.0, 2 COM, PCI Express Mini Card slot and 9 to 36 VDC
eBOX565-500-FL-DC-3955U	Fanless embedded system with Intel® Celeron® 3955U, 2 HDMI, 2 GbE LANs, 4 USB 3.0, 2 COM, PCI Express Mini Card slot and 9 to 36 VDC

### Optional

2.5" SATA HDD	64GB or above
2.5" SATA SSD	100GB or above
DDR4 SO-DIMM	2GB to 16GB
826K5601050E	Wall mount kit
8816K560AA0E	VESA arm kit
8816K560BA0E	DIN-rail kit
50906D24000E	24V 120W adapter
8816K5603A0E	Wi-Fi module

\* Specifications and certifications may vary based on different requirements.

## Dimensions

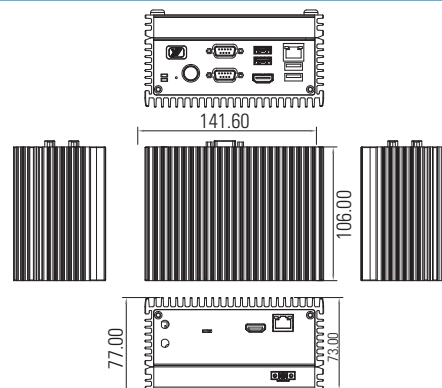

# eBOX625-312-FL NEW

Fanless Embedded System with Intel® Celeron® N3350 2.4 GHz/ Pentium® N4200 2.5 GHz, HDMI, VGA, 2 GbE LANs, 6 USB and 3 COM

## Features

- Intel® Celeron® N3350/Pentium® N4200 onboard
- 204-pin DDR3L-1866 SO-DIMM for up to 8GB of memory
- Supports 2 GbE LANs, 3 COM and 6 USB 3.0
- One 2.5" SATA drive bay and mSATA supported
- Trusted Platform Module (TPM) 1.2
- 2 PCI Express Mini Card slots and 1 SIM slot
- -40°C to +70°C operating temperature range
- AXView 2.0 intelligent remote monitoring software for IIoT



## Specifications

Standard Color	Silver
Construction	Aluminum extrusion and heavy-duty steel, IP40
CPU	Intel® Celeron® Processor N3350 2.4 GHz Intel® Pentium® Processor N4200, 2.5 GHz
System Memory	1 x 204-pin DDR3L-1866 SO-DIMM, up to 8GB
Chipset	SoC integrated
BIOS	AMI
System I/O Outlet	2 x RS-232/422/485 1 x RS-232 1 x HDMI (lockable) 1 x VGA 1 x Audio (Mic-in/Line-out) 2 x 10/100/1000 Mbps Ethernet (Intel® i211-IT) 4 x USB 3.0 2 x USB 2.0 4 x SMA-type antenna connector 1 x Screw type VDC power input connector 1 x AT/ATX switch 1 x ATX power switch
Watchdog Timer	65536 levels, 1 to 65535 sec.
Storage	1 x 2.5" SATA HDD drive bay (max. up 9.5 mm height) 1 x mSATA (enabled in BIOS setting)
Expansion Interface	2 x Full-size PCI Express Mini Card slot (USB + PCI Express signal) 1 x SIM slot
TPM	TPM 1.2
System Indicator	1 x green LED for system power-on 1 x yellow LED for HDD/SSD active
Power Supply	Input AC 90 to 264V, AC 60W adapter with lock Output: 12 VDC, 5A
Operating Temperature	Turbo Mode -20°C to +60°C (-4°F to +140°F) (with W.T. SSD/DRAM for 9 to 36 VDC) (Default) Non-turbo Mode -20°C to +65°C (-4°F to +149°F) (with W.T. SSD/DRAM for 12 or 24 VDC)
Humidity	10% to 95%, non-condensing
Shock Vibration	IEC 60068-2-27 (with SSD: 50G, half sine, 11 ms duration)
Vibration Endurance	IEC 60068-2-64 (with SSD: 3Grms STD, random, 5 to 500 Hz, 1 hr/axis)
Dimensions	200 mm (7.87") (W) x 120 mm (4.72") (D) x 46 mm (1.81") (H)
Weight (net/gross)	1.1 kg (2.43 lb)/1.8 kg (3.97 lb)
Certifications	CE, FCC Class A
EOS support	Win10 IoT, Linux, AXView 2.0

\* W.T.: Wide Temperature. All W.T. supported products have to be sorted by Axiomtek.

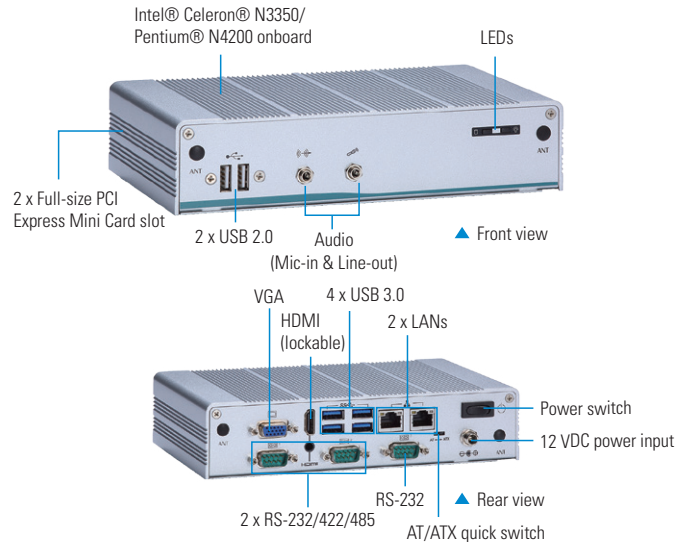

## Packing List

- 1 x Quick manual
- 1 x Driver CD
- 1 x Screws pack
- 4 x Pre-installed foot pad
- 1 x DRAM thermal pad

## Power Protection

### AC Version

- OVP (over voltage protection)
- UVP (under voltage protection)
- SCP (short current protection)

## Ordering Information

### Standard

eBOX625-312-FL-DC-N3350	Fanless embedded system with Intel® Celeron® N3350 2.4 GHz, HDMI, VGA, 2 GbE LANs, 6 USB and 3 COM
eBOX625-312-FL-DC-N4200	Fanless embedded system with Intel® Pentium® N4200 2.5 GHz, HDMI, VGA, 2 GbE LANs, 6 USB and 3 COM

### Optional

2.5" SATA HDD	64GB or above
2.5" SATA SSD	100GB or above
DDR3L SO-DIMM	2GB to 8GB
mSATA	64MB or above
8816K6271AOE	Wall mount Kit
8816K6272AOE	VESA mount kit
8816K6273AOE	DIN-rail kit
881606208AOE	Wi-Fi module
	3G/LTE module
50966124050E	12V/60W power adapter

\* Specifications and certifications may vary based on different requirements.

## Dimensions

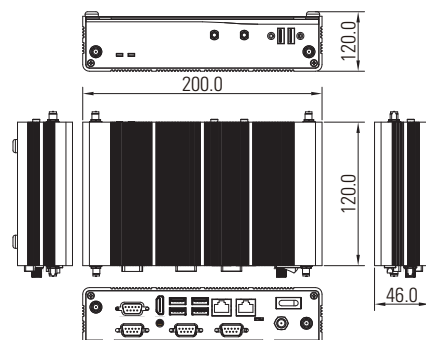



# eBOX625-853-FL

Fanless Embedded System with Intel® Celeron® Processor N3160, VGA, HDMI, 4 COM, 2 GbE LANs, 4 USB, and 2 PCI Express Mini Card Slots

## Features

- Intel® Celeron® Processor N3160 2.24 GHz (Braswell)
- HDMI and VGA with dual view supported
- Supports 4 COM and 4 USB
- 2 GbE LANs support WoL, Teaming and PXE
- 2 PCI Express Mini Card slots for WLAN/WWAN/mSATA modules
- -20°C to +60°C operating temperature range
- Intel® Virtualization Technology (Intel® VT-x)



## Specifications

Standard Color	Silver-black
Construction	Aluminum extrusion and heavy-duty steel, IP40
CPU	Intel® Celeron® processor N3160 2.24 GHz (2M Cache, up to 2.24 GHz)
System Memory	1 x 204-pin DDR3L-1333/1600 SO-DIMM, up to 8GB
Chipset	SoC integrated
BIOS	AMI
System I/O Outlet	2 x 10/100/1000 Mbps Ethernet (Intel® i211-AT) 1 x RS-232/422/485 3 x RS-232 3 x USB 3.0 1 x USB 2.0 1 x Audio (Mic-in/Line-out) 1 x HDMI (4K supported) 1 x VGA 1 x Screw type VDC power input connector 1 x ATX power switch 1 x Remote power switch 1 x Reset switch 1 x AT/ATX quick switch 3 x Antenna opening 8-CH programmable DIO (optional)
Watchdog Timer	255 levels, 1 to 255 sec.
Storage	1 x 2.5" HDD drive bay (max. up 15 mm height) 1 x mSATA (enabled in BIOS setting)
Expansion Interface	1 x Full-size PCI Express Mini Card slot (PCI Express + USB signal) 1 x Full-size PCI Express Mini Card slot (PCI Express + SATA signal) 1 x SIM slot
TPM	N/A
System Indicator	1 x green LED for system power-on 1 x yellow LED for HDD active
Power Supply	Input: AC 90-264V, AC 36 W adapter with lock Output: DC 12V@3A
Operating Temperature	-20°C to +60°C (-4°F to +140°F) (with W.T. SSD/DRAM)
Humidity	10% to 95%, non-condensing
Vibration Endurance	3 Grms with SSD (5 to 500Hz, X, Y, Z directions)
Dimensions	200 mm (7.87") (W) x 120 mm (4.72") (D) x 46 mm (1.81") (H)
Weight (net/gross)	1.2 kg (2.65 lb)/1.9 kg (4.19 lb)
Certifications	CE
EOS support	WEST7, WE8S, Win 10 IoT, Linux

\* W.T.: Wide Temperature. All W.T. supported products have to be sorted by Axiomtek.

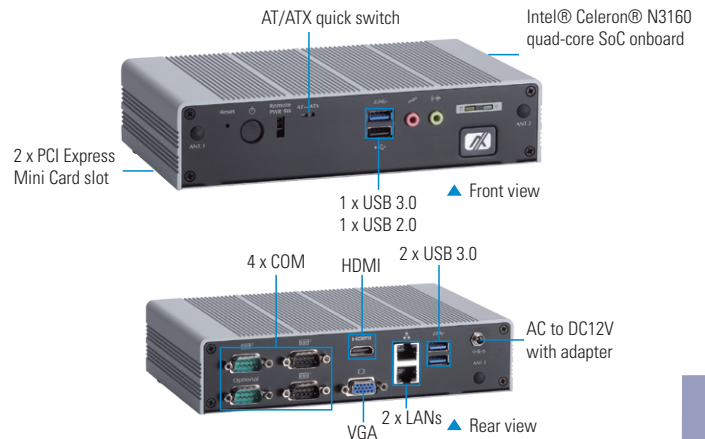

## Power Protection

### AC Version

- OVP (over voltage protection)
- UVP (under voltage protection)
- SCP (short current protection)

## Ordering Information

### Standard

eBOX625-853-FL-N3160-US	Fanless embedded system with Intel® Celeron® N3160, VGA, HDMI, 4 COM, 2 GbE LANs, 4 USB, 2 PCI Express Mini Card slots, AC/DC adapter and US power cord
eBOX625-853-FL-N3160-EU	Fanless embedded system with Intel® Celeron® N3160, VGA, HDMI, 4 COM, 2 GbE LANs, 4 USB, 2 PCI Express Mini Card slots, AC/DC adapter and EU power cord
eBOX625-853-FL-N3160-US-DIO	Fanless embedded system with Intel® Celeron® N3160, VGA, HDMI, 3 COM, 1 DIO, 2 GbE LANs, 4 USB, 2 PCI Express Mini Card, AC/DC adapter and US power cord

### Optional

2.5" SATA HDD	64GB or above
2.5" SATA SSD	100GB or above
DDR3L SO-DIMM	2GB to 8GB
mSATA	64MB or above
8816K6271AOE	Wall mount Kit
8816K6272AOE	VESA mount kit
8816K6273AOE	DIN-rail kit
8816K6603AOE	Wi-Fi module
	3G/LTE module

\* Specifications and certifications may vary based on different requirements.

## Dimensions

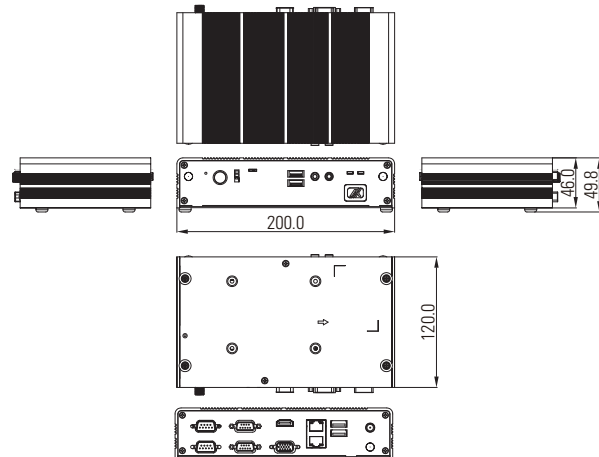

# eBOX626-853-FL

Fanless Embedded System with Intel® Celeron® Processor N3160, VGA, HDMI, 4 COM, 2 GbE LANs, 4 USB, 2 PCI Express Mini Card Slots and 9 to 36 VDC

## Features

- Intel® Celeron® processor N3160 2.24 GHz (Braswell)
- HDMI and VGA with dual independent displays
- Supports 4 COM and 4 USB
- 2 GbE LANs support WoL, Teaming and PXE
- 2 PCI Express Mini Card slots for WLAN/WWAN/mSATA modules
- 9 to 36 VDC wide range power input
- -20°C to +60°C operating temperature range

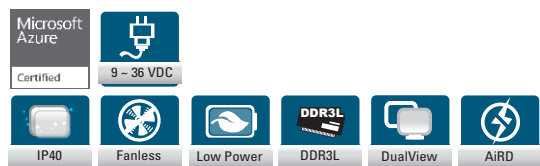

## Specifications

Standard Color	Silver-black
Construction	Aluminum extrusion and heavy-duty steel, IP40
CPU	Intel® Celeron® processor N3160 2.24 GHz (2M up to 2.24 GHz)
System Memory	1 x 204-pin DDR3L-1333/1600 SO-DIMM, up to 8GB
Chipset	SoC integrated
BIOS	AMI
System I/O Outlet	2 x 10/100/1000 Mbps Ethernet (Intel® i211-AT) 1 x RS-232/422/485 3 x RS-232 3 x USB 3.0 1 x USB 2.0 1 x Audio (Mic-in/Line-out) 1 x HDMI (4K supported) 1 x VGA 1 x Phoenix type VDC power input connector 1 x ATX power switch 1 x Remote power switch 1 x Reset switch 1 x AT/ATX quick switch 3 x Antenna opening 8-CH programmable DIO (optional)
Watchdog Timer	255 levels, 1 to 255 sec.
Storage	1 x 2.5" SATA HDD drive bay (max. up 15 mm height) 1 x mSATA (enabled in BIOS setting)
Expansion Interface	1 x Full-size PCI Express Mini Card slot (PCI Express + USB signal) 1 x Full-size PCI Express Mini Card slot (PCI Express + SATA signal) 1 x SIM slot
TPM	N/A
System Indicator	1 x green LED for system power-on 1 x yellow LED for HDD active
Power Input	42.5 W, 9 to 36 VDC
Operating Temperature	Standard: -20°C to +60°C (-4°F to +140°F) Boost mode: -20°C to +55°C (-4°F to +131°F) (with W.T. SSD/DRAM)
Humidity	10% to 95%, non-condensing
Vibration Endurance	3 Grms with SSD (5 to 500Hz, X, Y, Z directions)
Dimensions	200 mm (7.87") (W) x 120 mm (4.72") (D) x 46 mm (1.81") (H)
Weight (net/gross)	1.2 kg (2.65 lb)/1.9 kg (4.19 lb)
Certifications	CE
EOS support	WES7, WE8S, Linux

\* W.T.: Wide Temperature. All W.T. supported products have to be sorted by Axiomtek.

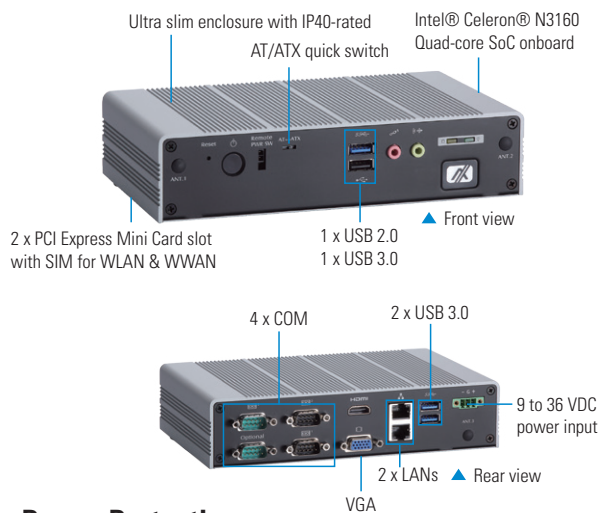

## Power Protection

### DC Version

- OVP (over voltage protection)
- UVP (under voltage protection)
- OCP (over current protection)
- Reverse protection

## Ordering Information

### Standard

eBOX626-853-FL-N3160-DC	Fanless embedded system with Intel® Celeron® N3160, VGA, HDMI, 4 COM, 2 GbE LANs, 4 USB, 2 PCI Express Mini Card slots and 9 to 36 VDC
eBOX626-853-FL-N3160-DC-DIO	Fanless embedded system with Intel® Celeron® N3160, VGA, HDMI, 3 COM, 1 DIO, 2 GbE LANs, 4 USB, 2 PCI Express Mini Card slots and 9 to 36 VDC

### Optional

2.5" SATA HDD	64GB or above
2.5" SATA SSD	100GB or above
DDR3L SO-DIMM	2GB to 8GB
mSATA	64MB or above
8816K6271A0E	Wall mount Kit
8816K6272A0E	VESA mount kit
8816K6273A0E	DIN-rail kit
8816K6603A0E	Wi-Fi module 3G/LTE module

\* Specifications and certifications may vary based on different requirements.

## Dimensions

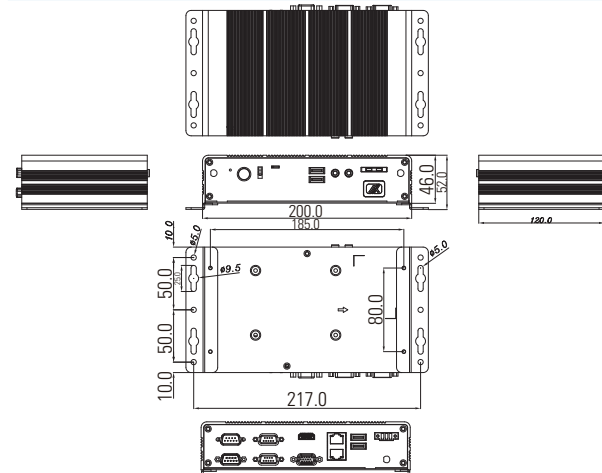

# eBOX627-312-FL NEW

Fanless Embedded System with Intel® Celeron® N3350 2.4 GHz/Pentium® N4200 2.5 GHz, HDMI, 2 GbE LANs, 6 USB, 4 COM and 9 to 36 VDC

## Features

- Intel® Celeron® N3350/Pentium® N4200 onboard
- 204-pin DDR3L-1866 SO-DIMM for up to 8GB of memory
- Support HDMI, 2 GbE LANs, 4 COM and 6 USB
- Flexible I/O Window supported
- Trusted Platform Module 1.2 (TPM) 1.2
- -20°C to +70°C operating temperature range
- 9 to 36 VDC wide range DC input
- AXView 2.0 intelligent remote monitoring software for IloT



## Specifications

Standard Color	Silver
Construction	Aluminum extrusion and heavy-duty steel, IP40
CPU	Intel® Celeron® Processor N3350 2.4 GHz Intel® Pentium® Processor N4200, 2.5 GHz
System Memory	1 x 204-pin DDR3L-1866 SO-DIMM, up to 8GB
Chipset	SoC integrated
BIOS	AMI
System I/O Outlet	2 x RS-232/422/485 2 x RS-232 1 x HDMI (lockable) 2 x 10/100/1000 Mbps Ethernet (Intel® i211-AT) 2 x USB 2.0 4 x USB 3.0 4 x SMA-type antenna connector 1 x Phoenix type VDC power input connector 1 x AT/ATX switch 1 x ATX power switch 1 x Flexible I/O Window (default : 2 x DB9 half cut bracket)
Watchdog Timer	65536 levels, 1 to 65535 sec.
Storage	1 x 2.5" HDD/SSD bay (max. up 9.5 mm height) 1 x mSATA (enabled in BIOS setting)
Expansion Interface	2 x Full-size PCI Express Mini Card slot (USB + PCI Express signal) 1 x SIM slot
TPM	TPM 1.2
System Indicator	1 x green LED for system power-on 1 x yellow LED for HDD/SSD active
Power Input	9 to 36 VDC
Operating Temperature	Turbo Mode -20°C to +65°C (-4°F to +149°F) (with W.T. SSD/DRAM for 9 to 36 VDC) (default) Non-turbo Mode -20°C to +70°C (-4°F to +158°F) (with W.T. SSD/DRAM for 12 or 24 VDC)
Humidity	10% to 95%, non-condensing
Shock	IEC 60068-2-27 (with SSD: 50G, half sine, 11 ms duration)
Dimensions	200 mm (7.87") (W) x 120 mm (4.72") (D) x 65 mm (2.55") (H)
Weight (net/gross)	1.38 kg (3.04 lb)/2.08 kg (4.59 lb)
Certifications	CE, FCC Class A
EOS support	Win 10 IoT, Linux, AXView 2.0

\* W.T.: Wide Temperature. All W.T. supported products have to be sorted by Axiomtek.

## Packing List

- 1 x Quick manual
- 1 x Driver CD
- 1 x Screws pack
- 1 x DRAM thermal pad
- 4 x Pre-installed foot pad
- 1 x 2-pin terminal block connector

\* All specifications and photos are subject to change without notice. [www.axiomtek.com](http://www.axiomtek.com) © 2019 Axiomtek Co., Ltd. All rights reserved.

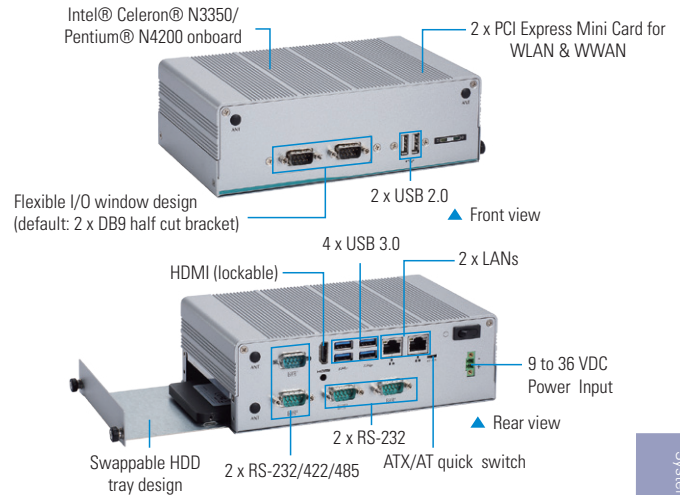

## Power Protection

### AC Version

- OVP (over voltage protection)
- UVP (under voltage protection)
- SCP (short current protection)

## Ordering Information

### Standard

eBOX627-312-FL-DC-N3350	Fanless embedded system with Intel® Celeron® N3350 2.4 GHz, 1 HDMI, 2 GbE LANs, 6 USB, 4 COM and 9 to 36 VDC
eBOX627-312-FL-DC-N4200	Fanless embedded system with Intel® Celeron® N4200 2.5 GHz, 1 HDMI, 2 GbE LANs, 6 USB, 4 COM and 9 to 36 VDC

### Optional

2.5" SATA HDD	64GB or above
2.5" SATA SSD	100GB or above
DDR3L SO-DIMM	2GB to 8GB
mSATA	64GB or above
8816K6271A0E	Wall mount Kit
8816K6272A0E	VESA mount kit
8816K6273A0E	DIN-rail kit
50906D24000E	24V 120W adapter
881606209A0E	Wi-Fi module
	3G/LTE module
E392903102	AX92903 CANbus PCI Express Mini module
E392903103	AX92903 CAN module with CANOpen
E392902103	AX92902 LAN PCI Express Mini module
E392906101	AX92906 COM PCI Express Mini module
E392904102	AX92904 DIO PCI Express Mini module

\* Specifications and certifications may vary based on different requirements.

## Dimensions

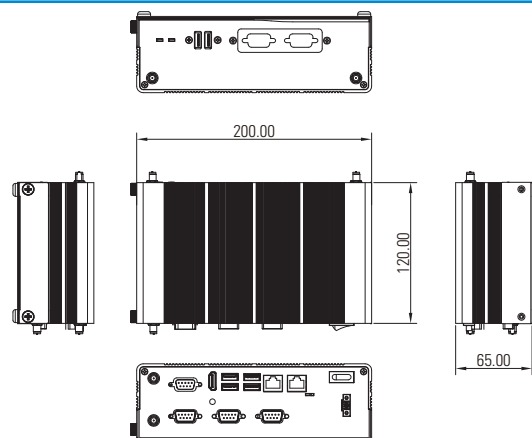

# eBOX638-842-FL NEW

Fanless Embedded System with Intel® Celeron® Processor J1900, VGA, HDMI, 4 COM, 6 USB, Dual Expansion Slots and 9 to 36 VDC Input

## Features

- Intel® Celeron® Processor J1900 2.0 GHz
- Fanless operation design with full feature I/O
- HDMI and VGA with dual-view supported
- 6 USB, 2 LANs and 4 COM
- PCI Express Mini Card slot
- Flexible I/O window design
- Dual PCI or PCIe x1 expansion slots
- 9 to 36 VDC wide range power input



## Specifications

Standard Color	Silver
Construction	Aluminum extrusion and heavy-duty steel, IP40
CPU	Intel® Celeron® Quad-Core J1900 2.0 GHz
System Memory	1 x 204-pin DDR3L-1066/1333 SO-DIMM, up to 8GB
Chipset	SoC integrated
BIOS	AMI
System I/O Outlet	2 x RS-232/422/485 2 x RS-232 2 x 10/100/1000Mbps Ethernet (Realtek 8111F) 5 x USB 2.0 1 x USB 3.0 1 x Audio (Mic-in/Line-out) 1 x PS/2 keyboard & mouse 1 x HDMI 1 x VGA 1 x VDC power input connector 1 x ATX power switch 1 x Reset switch 2 x SMA-type antenna connector 1 x Flexible I/O window (default: 2 x DB9 half cut bracket)
Watchdog Timer	255 levels, 1 to 255 sec.
Storage	1 x 2.5" SATA HDD drive bay (max. up 15 mm height) 1 x mSATA (enabled in BIOS setting)
Expansion Interface	2 x PCI or 2 x PCIe x1 slots 1 x Full-size PCI Express Mini Card slot (PCI Express + USB signal) 1 x SIM slot
TPM	N/A
System Indicator	1 x green LED for system power 1 x yellow LED for HDD active
Power Input	9 to 36 VDC
Operating Temperature	-10°C to +55°C (14°F to +131 F) (with W.T. DRAM & SSD)
Humidity	10% to 90%, non-condensing
Vibration Endurance	2 Grms with SSD (5 to 500 Hz, X, Y, Z directions)
Dimensions	192mm (7.56") (W) x 230 mm (9.05") (D) x 115.8 mm (4.56") (H)
Weight (net/gross)	4.1 kg (9.03 lb)/4.8 kg (10.58 lb)
Certifications	CE compliance
EOS support	WES7, Win 10 IoT

\* W.T.: Wide Temperature. All W.T. supported products have to be sorted by Axiomtek.

## Packing List

- 1 x Quick manual
- 1 x Driver CD
- 1 x Screw pack
- 1 x 2-pin terminal block connector
- 1 x PCI riser card or 1 x PCIe riser card



## Power Protection

### DC Version

- OCP (over current protection)
- OVP (over voltage protection)
- SCP (short circuit protection)

## Ordering Information

### Standard

eBOX638-842-FL-2 PCI	Fanless embedded system with Intel® Celeron® processor J1900 2.0 GHz, VGA, HDMI, 4 COM, 6 USB, 2 PCI slots and 9 to 36 VDC input
eBOX638-842-FL-2 PCIe	Fanless embedded system with Intel® Celeron® processor J1900 2.0 GHz, VGA, HDMI, 4 COM, 6 USB, 2 PCIe x1 slots and 9 to 36 VDC input

### Optional

2.5" SATA HDD	64GB or above
2.5" SATA SSD	100GB or above
DDR3L SO-DIMM	2GB to 8GB
mSATA	64MB or above
8816K6601A0E	Wi-Fi module
	3G/LTE module
881606390A0E	Wall mount Kit
E392903102	AX92903 CANbus PCI Express Mini module
E392903103	AX92903 CAN module with CANopen
E392902103	AX92902 LAN PCI Express Mini module
E392904102	AX92904 DIO PCI Express Mini module
59406382110E	RS-232 cable, P=2.54, L=300MM
50906D24000E	24V, 120W adapter

\* Specifications and certifications may vary based on different requirements.

## Dimensions

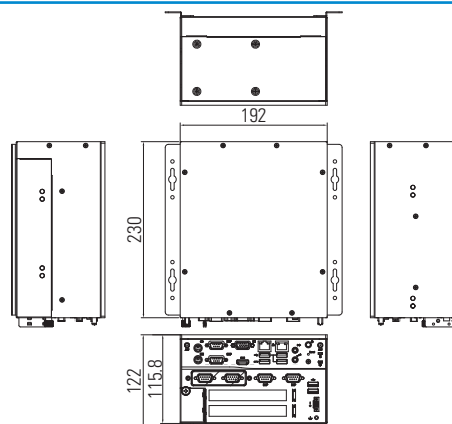

# eBOX640-500-FL

Fanless Embedded System with LGA1151 Socket 7th/6th Gen Intel® Core™ & Celeron® Processor, Intel® H110, HDMI, DisplayPort, VGA, 6 USB, 4 COM, PCI Express Mini Card Slot and 10 to 30 VDC

## Features

- LGA1151 socket 7th/6th gen Intel® Core™ i7/i5/i3 & Celeron® processor (Kaby Lake/Skylake)
- Supports 4 COM, 6 USB and 2 GbE LANs
- Two 2.5" SATA drive bay
- PCI Express Mini Card slot and SIM slot
- Front I/O connectivity design
- 10 to 30 VDC wide range power input



## Specifications

Standard Color	Silver-black
Construction	Aluminum extrusion and heavy-duty steel, IP40
CPU	7th/6th gen Intel® Core™ i7/i5/i3 & Celeron® processor (CPU TDP max. up to 35W)
System Memory	2 x 288-pin DDR4-2133 DIMM, up to 32GB
Chipset	Intel® H110
BIOS	AMI
System I/O Outlet	1 x RS-232/422/485 3 x RS-232 2 x 10/100/1000Mbps Ethernet (Intel® i219-LM, i211-AT) 2 x USB 2.0 4 x USB 3.0 1 x Audio (Mic-in/Line-out) 1 x DisplayPort 1 x HDMI 1 x VGA 1 x Phoenix type VDC power input connector 1 x AT/ATX quick switch 2 x SMA-type antenna connector 1 x ATX power switch
Watchdog Timer	255 levels, 1 to 255 sec.
Storage	2 x 2.5" SATA HDD drive bay (max. up to 15 mm height) 1 x mSATA (enabled in BIOS setting)
Expansion Interface	1x Full-size PCI Express Mini Card slot with mSATA supported (PCI Express + USB signal) 1 x SIM slot
TPM	N/A
System Indicator	1 x green for system power 1 x orange LED for HDD active
Power Input	10 to 30 VDC
Operating Temperature	-10°C to +55°C (+14°F to +131°F) (with W.T. DRAM/SSD for Skylake) -10°C to +50°C (+14°F to +122°F) (with W.T. DRAM/SSD for Kaby Lake)
Humidity	10% to 90%, non-condensing
Vibration Endurance	2 Grms with SSD (5 to 500 Hz, X, Y, Z directions)
Dimensions	182 mm (7.16") (W) x 235.7mm (9.27") (D) x 82 mm (3.23") (H)
Weight (net/gross)	3 kg (6.61 lb)/3.6 kg (7.94 lb)
Certifications	CE
EOS support	Win 10 IoT, WEBS Linux

\* W.T.: Wide Temperature. All W.T. supported products have to be sorted by Axiomtek.

## Packing List

- 1 x Quick manual
- 1 x Driver CD
- 1 x Screw pack
- 4 x Pre-installed foot pad
- 1 x 3-pin terminal block connector

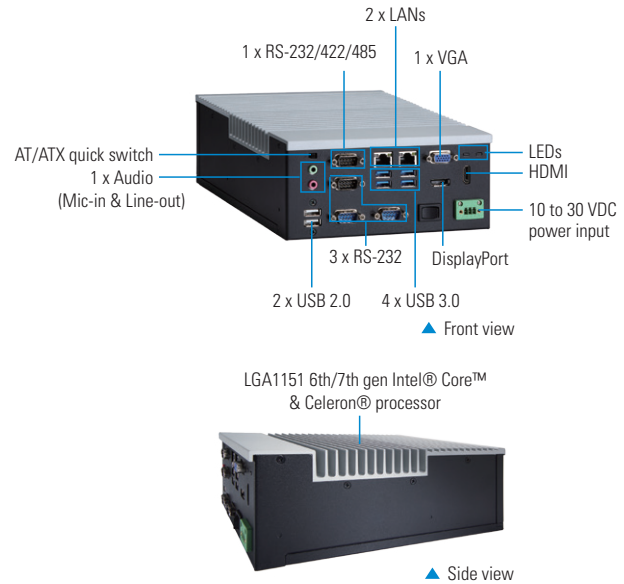

## Power Protection

### DC Version

- OCP (over current protection)
- UVP (under voltage protection)

## Ordering Information

### Standard

eBOX640-500-FL-DC	Fanless embedded system with LGA1151 7th/6th gen Intel® Core™ i7/i5/i3 & Celeron® processor, Intel® H110, HDMI/DP/VGA, 4 USB 3.0, 4 COM, PCI Express Mini Card slot and 10 to 30 VDC
-------------------	--

### Optional

2.5" SATA HDD	64GB or above
2.5" SATA SSD	100GB or above
DDR4 RAM	2GB to 16GB
mSATA	64MB or above
8816K6400A0E	Wall mount kit
8816K6401A0E	DIN-rail kit
	Wi-Fi module
	3G/LTE module
50906D24000E	24V 120W adapter

\* Specifications and certifications may vary based on different requirements.

## Dimensions

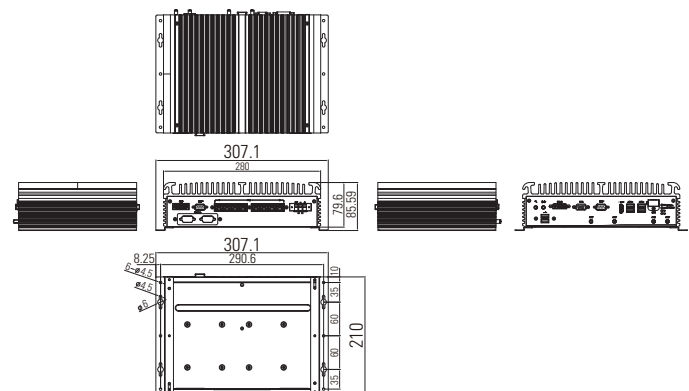



# eBOX670-891-FL

Fanless Embedded System with LGA1151 Socket 7th/6th Gen Intel® Core™ & Celeron® Processor, Intel® Q170, 2 HDMI, DisplayPort, 4 GbE LANs, 6 USB, 2 PCI Express Mini Card Slots

## Features

- LGA1151 socket 7th/6th gen Intel® Core™ i7/i5/i3 & Celeron® processors (Kaby Lake/Skylake)
- 1 DisplayPort and 2 HDMI (1 HDMI 2.0) with triple view supported
- Supports Jumbo Frame (9.5k), WoL, PXE Remote Boot, Teaming
- 9 to 36 VDC wide range power input
- Flexible I/O window design
- AXView 2.0 intelligent remote monitoring software for IIoT



## Specifications

Standard Color	Silver-black
Construction	Aluminum extrusion and heavy-duty steel, IP40
CPU	LGA1151 socket 7th/6th gen Intel® Core™ i7/i5/i3 & Celeron® processor (CPU TDP max. up to 35W)
System Memory	2 x 260-pin DDR4-2133 MHz SO-DIMM, up to 32GB
Chipset	Intel® Q170
BIOS	AMI
System I/O Outlet	2 x RS-232/422/485 (onboard) 2 x RS-232/422/485 (via cable on flexible IO window) 2 x HDMI (1 x HDMI 2.0 & 1 x HDMI 1.4b) 1 x DisplayPort 1 x Audio (Mic-in/Line-out) 4 x 10/100/1000 Mbps Ethernet (Intel® i210-IT, i219-LM) 4 x USB 3.0 & 2 x USB 2.0 32-channel programmable DI/DO 4 x SMA-type antenna connector 1 x Phoenix type VDC power input connector 1 x ATX power switch 1 x Remote power switch 1 x AT/ATX quick switch 1 x Reset switch 1 x Flexible I/O window (default : 2 x COM port)
Watchdog Timer	255 levels, 1 to 255 sec.
Storage	2 x 2.5" SATA HDD drive bay (max. up 15 mm height & Supports RAID 0 & 1) 1 x CFast™ 1 x mSATA (enabled in BIOS setting)
Expansion Interface	2 x Full-size PCI Express Mini Card slot (USB + PCI Express signal) 1 x SIM slot
System Indicator	1 x green LED for power-on 1 x yellow LED for HDD active 4 x green LED for programmable
TPM	N/A
Power Input	9 to 36 VDC
Operating Temperature	-40°C to +60°C (-40°F to +140°F) (with W.T. DRAM/SSD for Skylake) -40°C to +55°C (-40°F to +131°F) (with W.T. DRAM/SSD for Kaby Lake)
Humidity	10% to 95%, non-condensing
Vibration Endurance	3 Grms with CFast™ (5 to 500 Hz, X, Y, Z directions)
Dimensions	280 mm (11.02") (W) x 190 mm (7.48") (D) x 76 mm (2.99") (H)
Weight (net/gross)	3.8 kg (8.37 lb)/4.6 kg (10.14 lb)
Certifications	CE, FCC Class A
EOS Support	WEBS, Win 10 IoT, Linux, AXView 2.0

\* W.T.: Wide Temperature. All W.T. supported products have to be sorted by Axiomtek.

## Packing List

1 x Quick manual	1 x Terminal block connector
1 x Driver CD	1 x Remote switch cable
1 x Screw pack	2 x HDD bracket
4 x Pre-installed foot pad	1 x CPU thermal pad

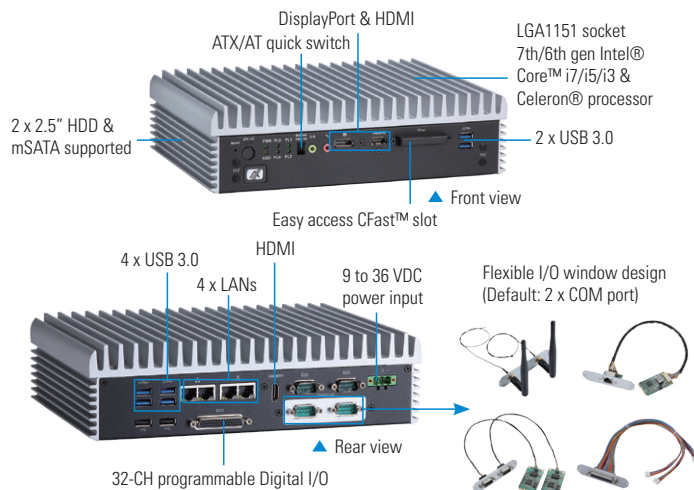

## Power Protection

### DC Version

OVP (over voltage protection)  
UVP (under voltage protection)  
OCP (over current protection)  
SCP (short circuit protection)  
Reverse protection

## Ordering Information

### Standard

eBOX670-891-FL-DC-Flexible IO	Fanless embedded system with LGA1151 socket 7th/6th gen Intel® Core™ i7/i5/i3 & Celeron® processor, Intel® Q170, 2 HDMI, DisplayPort, 4 GbE LANs, 6 USB, CFast™, dual PCI Express Mini Card slots and 9 to 36 VDC
-------------------------------	---

### Optional

2.5" SATA HDD	64GB or above
2.5" SATA SSD	100GB or above
DDR4 SO-DIMM	2GB to 16GB
CFast™	64GB (W.T.)
8816K6603A0E	Wi-Fi module
	3G/LTE module
8816K6701A0E	Wall mount kit
8816K6702A0E	DIN-rail kit
50906D24000E	24V 120W adapter
E392903102	AX92903 CANbus PCI Express Mini module
E392903103	AX92903 CAN module with CANopen
E392902103	AX92902 LAN PCI Express Mini module
E392904102	AX92904 DIO PCI Express Mini module

\* Specifications and certifications may vary based on different requirements.

## Dimensions

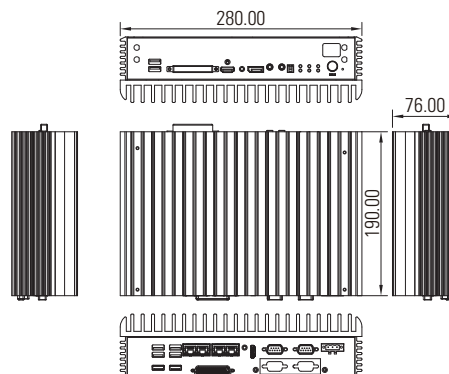

# eBOX671-517-FL NEW

Fanless Embedded System with LGA1151 Socket 7th/6th Gen Intel® Core™ i7/i5/i3 & Celeron® Processor, Intel® Q170, HDMI, DVI-D, VGA, 8-CH PoE, 6 USB and 9 to 36 VDC

## Features

- 7th/6th gen Intel® Core™ i7/i5/i3 & Celeron® processor (35W/65W)
- 8-CH PoE/GbE onboard
- Supports 6 USB ports and 4 GbE LANs
- 2.5" SATA HDD drive bay and mSATA slot
- -40°C to +70°C extended operating temperature

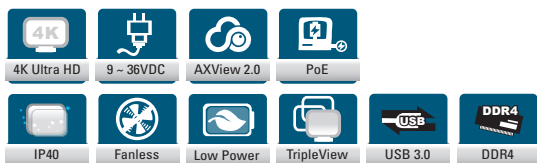

## Specifications

Standard Color	Silver
Construction	Aluminum extrusion and heavy-duty steel, IP40
CPU	LGA1151 socket 7th/6th gen Intel® Core™ i7/i5/i3 & Celeron® processor (35W/65W)
System Memory	2 x 260-pin DDR4 non-ECC SO-DIMM, up to 32GB
Chipset	Intel® Q170
BIOS	AMI UEFI BIOS
System I/O Outlet	2 x RS-232/422/485 1 x HDMI 1.4b 1 x VGA 1 x DVI-D 1 x Audio (Line-out & MIC-in) 8 x Gigabit PoE (IEEE 802.3af) port (Intel® i211-AT, max. up to 120W) 4 x USB 3.0 2 x USB 2.0 4 x SMA-type antenna connector 1 x Phoenix type VDC power input connector 1 x 6-in/2-out isolated DIO 1 x Power switch 1 x Reset switch 1 x Flexible I/O window (default : 2 x DB9 half cut bracket)
Watchdog Timer	255 levels, 1 to 255 sec.
Storage	1 x 2.5" SATA HDD drive bay (max. up 15 mm height) 1 x mSATA (enabled in BIOS setting)
Expansion Interface	2 x Full-size PCI Express Mini Card slot (USB + PCIe + SIM) 1 x Half-size PCI Express Mini Card slot (USB only) 1 x Half-size PCI Express mini card slot (USB + PCIe + mSATA)
TPM	N/A
System Indicator	1 x green LED for system power-on 1 x yellow LED for HDD active 2 x Programmable green LED
Power Input	9 to 36 VDC (ACC default disable by project option)
Operating Temperature	-40°C to +55°C (-40°F to +131° F) (W.T. DRAM & SSD) (KBL Gen,35W/65W) -40°C to +70°C (-40°F to +158° F) SKL Gen,35W/65W)
Humidity	10% to 90%, non-condensing
Shock	IEC 60068-2-27 (with SSD: 50G, half sine, 11 ms duration)
Vibration Endurance	IEC 60068-2-64 (with SSD: 3Grms STD, random, 5 - 500 Hz, 1 hr/axis)
Dimensions	280mm (11.2") (W) x 210mm (8.26") (D) x 79.6 mm (3.13") (H)
Weight (net/gross)	4.31 kg (9.5 lb)/5.1 kg (11.24 lb)
Certifications	CE, FCC Class A
EOS Support	Win 10 IoT, Linux, AXView 2.0

\* W.T.: Wide Temperature. All W.T. supported products have to be sorted by Axiomtek.



## Packing List

- 1 x Quick manual
- 1 x Driver CD
- 1 x Remote power cable
- 1 x Terminal block connector
- 4 x Pre-installed foot pad

## Power Protection

### DC Version

- OVP (over voltage protection)
- UVP (under voltage protection)
- SCP (short current protection)

## Ordering Information

### Standard

eBOX671-517-FL-PoE	Fanless embedded system with LGA1151 socket 7th/6th gen Intel® Core™ i7/i5/i3 & Celeron® processor, Intel® Q170, VGA, DVI-D, HDMI, 8-CH PoE, 6 USB and 9 to 36 VDC
--------------------	--

### Optional

2.5" SATA HDD	80GB or above
2.5" SATA SSD	100GB or above
DDR4 SO-DIMM	4GB to 16GB
mSATA	64GB or above
	Wi-Fi module
	3G/LTE module
	Wall mount kit
	DIN-rail kit
50906D24000E	24V 120W adapter
E392903102	AX92903 CANbus PCI Express Mini module
E392903103	AX92903 CAN module with CANopen
E392902103	AX92902 LAN PCI Express Mini module
E392906101	AX92906 COM PCI Express Mini module
E392904102	AX92904 DIO PCI Express Mini module

\* Specifications and certifications may vary based on different requirements.

## Dimensions

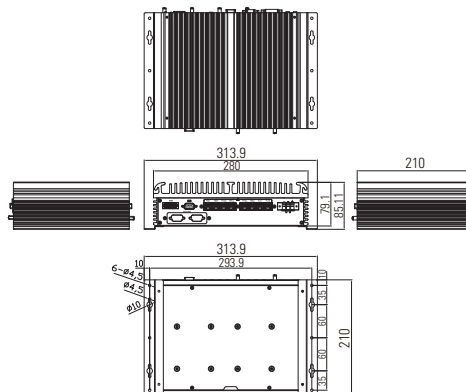

# eBOX671-521-FL NEW

Fanless Embedded System with LGA1151 8th Gen Intel® Core™ i7/i5/i3 & Celeron® Processors, 4-CH PoE and MXM Graphics Module

## Features

- 8th gen Intel® Core™ i7/i5/i3 & Celeron® with Intel® Q370 chipset (Coffee Lake-S)
- 4-CH GbE PoE (IEEE802.3at)
- Dual swappable 2.5" SATA HDD drive bay
- ECC memory supported by optional Intel® C246
- Supports MXM graphics module (optional)
- DVI-I, HDMI, and DisplayPort with triple-view supported
- AXView 2.0 intelligent remote monitoring software for IIoT



## Specifications

Standard Color	Silver
Construction	Aluminum extrusion and heavy-duty steel, IP40
CPU	LGA1151 8th gen Intel® Core™ i7/i5/i3 & Celeron® processors (35W/65W)
System Memory	2 x 260-pin DDR4-2666 SO-DIMM, up to 32GB (ECC supported by Intel® C246 PCH)
Chipset	Intel® Q370/optional Intel® C246 PCH
BIOS	AMI
System I/O Outlet	2 x RS-232/422/485 2 x DisplayPort via MXM module (optional) 1 x HDMI 1 x DisplayPort 1 x DVI-I 2 x 10/100/1000 Mbps Ethernet 4 x Gigabit PoE (IEEE 802.3at) port (max. up to 60W) 4 x USB 3.1 Gen2 2 x USB 3.1 Gen1 1 x Phoenix type VDC power input connector 1 x AT/ATX quick switch 1 x ATX power switch 1 x Reset switch 1 x Remote switch 1 x Flexible I/O window (Default : 2 x DB9 half cut bracket) 4 x SMA-type antenna connector
Watchdog Timer	255 levels, 1 to 255 sec.
Storage	2 x 2.5" HDD drive bay (max. up 9.5 mm height) 1 x mSATA (enabled in BIOS setting)
Expansion Interface	2 x Full-size PCI Express Mini Card slot (USB + PCIe signal) 2 x SIM slot
TPM	TPM 2.0
System Indicator	1 x blue LED for system power-on 1 x orange LED for HDD active 4 x Programmable LED
Power Input	24 VDC
Operating Temperature	-20°C to 60°C (4°F to +140°F) (with W.T. DRAM & SSD, CPU TDP 35W) -20°C to 50°C (4°F to +122°F) (with W.T. DRAM & SSD, CPU TDP 65W)
Humidity	10% to 90%, non-condensing
Shock Vibration	IEC 60068-2-27 (w/SSD: 50G@wall mount, half sine, 11 ms duration)
Vibration Endurance	IEC 60068-2-64 (w/SSD: 3Grms STD, random, 5 - 500 Hz, 1 hr/axis)
Dimensions	280mm (11.02") (W) x 210mm (8.26") (D) x 80.5mm (3.16") (H)
Weight (net/gross)	4.8 kg (10.58 lb)/5.6 kg (12.34 lb)
Certifications	CE, FCC Class A
EOS Support	Win 10 IoT, Linux, AXView 2.0

\* W.T.: Wide Temperature. All W.T. supported products have to be sorted by Axiomtek.

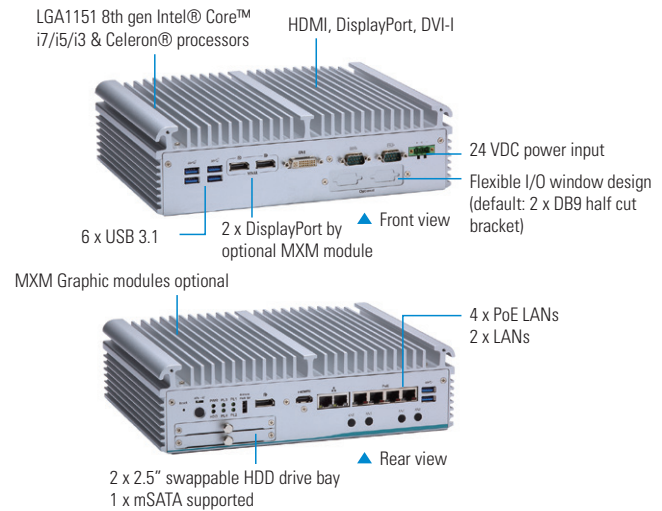

## Packing List

- 1 x Quick manual
- 1 x Driver CD
- 1 x Screw pack
- 4 x Pre-installed foot pad
- 1 x 3-pin terminal block connector
- 1 x Remote switch cable

## Power Protection

### DC Version

- OVP (over voltage protection)
- UVP (under voltage protection)
- OCV (over current protection)
- SCP (short circuit protection)
- Reserve protection

## Ordering Information

### Standard

eBOX671-521-FL-DC-Q370	Fanless embedded system with LGA1151 8th gen Intel® Core™ i7/i5/i3 & Celeron® processor, Intel® Q370, DVI-I, HDMI, dual HDD, 4 PoE, 2 GbE LANs, 6 USB, 2 COM and 24 VDC
------------------------	---

### Optional

2.5" SATA HDD	80GB or above
2.5" SATA SSD	100GB or above
DDR4 SO-DIMM	4GB to 16GB
mSATA	64GB or above
	Wall mount kit
	DIN-rail kit
	Wi-Fi module
	3G/LTE module
TBC	MXM module
TBC	MXM Fan kit
50906D24000E	24V, 2W adapter
E392903102	AX92903 CANbus PCI Express Mini module
E392903103	AX92903 CAN module with CANOpen
E392902103	AX92902 LAN PCI Express Mini module
AX92906101	AX92906 COM PCI Express Mini module
E392904102	AX92904 DIO PCI Express Mini module

\* Specifications and certifications may vary based on different requirements.

# eBOX700-891-FL

Fanless Embedded System with LGA1151 Socket 7th/6th Gen Intel® Core™ i7/i5/i3 & Celeron® Processor, Intel® H110, 2 HDMI, DisplayPort, 4 GbE LANs, 6 USB, PCIe x4/PCI Slot and 9 to 36 VDC

## Features

- Fanless operating temperature range from -40°C to +50°C
- 7th/6th gen Intel® Core™ i7/i5/i3 & Celeron® processors
- PCIe x4 or PCI expansion slot supported
- Supports 6 USB ports and 4 GbE LANs
- 2 PCI Express Mini Card slots for WLAN/WWAN/mSATA modules
- 1 internal USB Type A connector for Dongle Kit
- AXView 2.0 intelligent remote monitoring software for IIoT

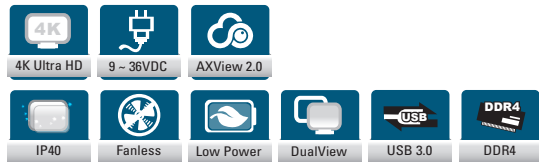

## Specifications

Standard Color	Silver
Construction	Aluminum extrusion and heavy-duty steel, IP40
CPU	LGA1151 socket 7th/6th gen Intel® Core™ i7/i5/i3 & Celeron® processor (CPU TDP max. up to 35 W)
System Memory	2 x 260-pin DDR4-2133 SO-DIMM, up to 32GB
Chipset	Intel® H110
BIOS	AMI UEFI BIOS
System I/O Outlet	2 x RS-232/422/485 2 x HDMI (1 x HDMI 2.0 & 1 x HDMI 1.4b) 1 x DisplayPort 1 x Audio (Mic-in/Line-out) 4 x 10/100/1000 Mbps Ethernet (Intel® i210-IT, i219-LM) 4 x USB 3.0 2 x USB 2.0 4 x SMA-type antenna connector 1 x Phoenix type VDC power input connector 1 x ATX power switch 1 x Remote power switch 1 x ATX/AT quick switch 1 x Reset switch 1 x Flexible I/O window (default: 2 x DB9 half cut bracket)
Watchdog Timer	255 levels, 1 to 255 sec.
Storage	1 x 2.5" SATA HDD drive bay (max. up 15 mm height) 1 x mSATA (enabled in BIOS setting)
Expansion Interface	2 x Full-size PCI Express Mini Card slot (USB + PCI Express signal) 1 x SIM slot 1 x PCIe x4 slot or 1 x PCI slot 1 x Internal USB Type A for license dongle kit usage
TPM	N/A
System Indicator	1 x green LED for system power-on 1 x yellow LED for HDD active 4 x Programmable green LED
Power Input	9 to 36 VDC
Operating Temperature	-40°C to +50°C (-40°F to +122° F) (with W.T. SSD/DRAM)
Humidity	10% to 90%, non-condensing
Vibration Endurance	3 Grms with SSD (5 to 500Hz, X, Y, Z directions)
Dimensions	280 mm (11.02") (W) x 190 mm (7.48") (D) x 76 mm (2.99") (H)
Weight (net/gross)	3.8 kg (8.37 lb)/4.6 kg (10.14 lb)
Certifications	CE, FCC Class A
EOS Support	Win 10 IoT, Linux, AXView 2.0

\* W.T.: Wide Temperature. All W.T. supported products have to be sorted by Axiomtek.

## Packing List

- 1 x Quick manual
- 1 x Driver CD
- 1 x Remote power cable
- 1 x Terminal block connector
- 4 x Pre-installed foot pad

\* All specifications and photos are subject to change without notice. [www.axiomtek.com](http://www.axiomtek.com) © 2019 Axiomtek Co., Ltd. All rights reserved.

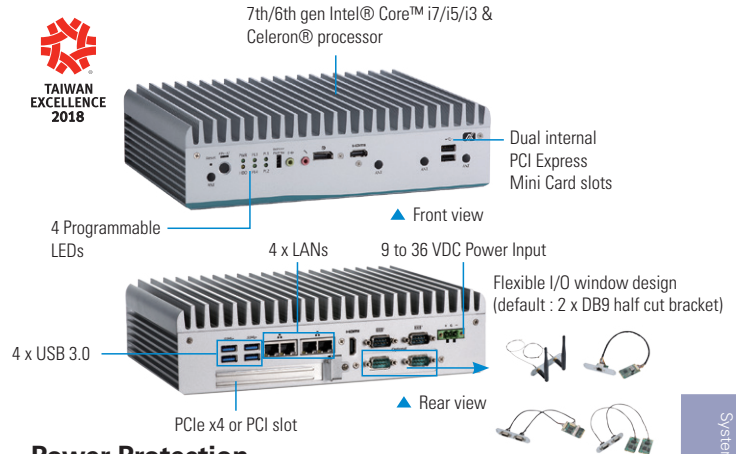

## Power Protection

### DC Version

- OVP (over voltage protection)
- UVP (under voltage protection)
- SCP (short current protection)

## Ordering Information

### Standard

eBOX700-891-FL-PCIe-DC	Fanless embedded system with LGA1151 socket 7th/6th gen Intel® Core™ i7/i5/i3 & Celeron® processor, Intel® H110, 2 HDMI, DisplayPort, 4 GbE LANs, 6 USB, PCIe x4 expansion and 9 to 36 VDC
eBOX700-891-FL-PCI-DC	Fanless embedded system with LGA1151 socket 7th/6th gen Intel® Core™ i7/i5/i3 & Celeron® processor, Intel® H110, 2 HDMI, DisplayPort, 4 GbE LANs, 6 USB, PCI expansion and 9 to 36 VDC

### Optional

2.5" SATA HDD	80GB or above
2.5" SATA SSD	100GB or above
DDR4 SO-DIMM	4GB to 16GB
8816K6603A0E	Wi-Fi module
	3G/LTE module
8816K7000A0E	Wall mount kit
8816K6702A0E	DIN-rail kit
50906D24000E	24V 120W adapter
E392903102	AX92903 CANbus PCI Express Mini module
E392903103	AX92903 CAN module with CANOpen
E392902103	AX92902 LAN PCI Express Mini module
E392906101	AX92906 COM PCI Express Mini module
E392904102	AX92904 DIO PCI Express Mini module

\* Specifications and certifications may vary based on different requirements.

## Dimensions

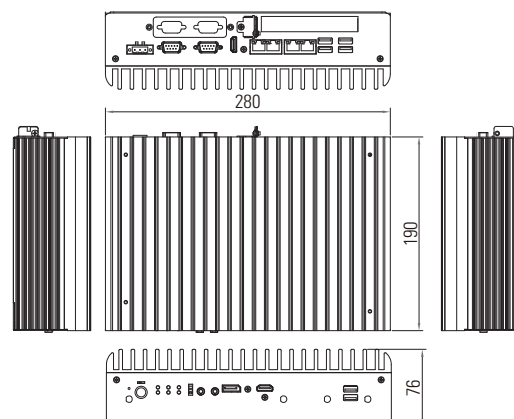

# eBOX800-841-FL

Rugged IP67-rated Fanless Embedded System with Intel® Atom® Processor E3845, VGA, 2 GbE LANs, 2 USB, 2 COM and 9 to 36 VDC

## Features

- IP67-rating for outdoor use
- Intel® Atom® processor E3845 onboard
- 4 N-jack antenna openings with water proof design
- -30°C to +60°C operating temperature range
- 9 to 36 VDC wide range power input
- Features M12 lockable I/Os
- Rich I/O options for customized designs and mission-critical projects
- Trusted Platform Module 1.2 (TPM) 1.2



## Specifications

Standard Color	Black
Construction	Aluminum die-casting and heavy-duty steel, IP67
CPU	Intel® Atom® processor E3845 1.91 GHz
System Memory	1 x 204-pin DDR3L-1066/1333 SO-DIMM, up to 8GB
Chipset	SoC integrated
BIOS	AMI
System I/O Outlet	2 x RS-232/422/485 (M12) 1 x VGA (M12) 2 x 10/100/1000 Mbps Ethernet (Intel® i210-IT, M12) 2 x USB 2.0 (M12) 1 x 9 to 36 VDC power input (M12) 1 x ATX power switch with indicator 4 x N-jack antenna opening with water proof design
Watchdog Timer	255 levels, 1 to 255 sec.
Storage	1 x 2.5" HDD drive bay (max. up 9.5 mm height) 1 x mSATA (enabled in BIOS setting) 1 x CFast™
Expansion Interface	1 x Full-size PCI Express Mini Card slot (USB + PCI Express signal) 1 x Half-size PCI Express Mini Card slot (USB + PCI Express signal) 1 x SIM slot
TPM	TPM 1.2
System Indicator	1 x Green LED for system power-on
Power Input	9 to 36 VDC
Operating Temperature	-30°C to +60°C (-22°F to +140°F) (with E3845, W.T. SSD/DRAM)
Humidity	10% to 95% , non-condensing
Vibration Endurance	3 Grms with SSD (5 to 500Hz, X, Y, Z directions)
Dimensions	210 mm (8.27") x 366.83 mm (14.44") x 83 mm (3.27")
Weight (net/gross)	4.31 kg (9.5 lb)/5.1 kg (11.24 lb)
Certifications	CE, FCC Class A
EOS (Support)	Win 10 IoT, WE8S, WE57, Linux

\* W.T.: Wide Temperature. All W.T. supported products have to be sorted by Axiomtek.

## Packing List

- 1 x Quick manual
- 1 x Driver CD
- 1 x Water-proof PWR cable (100 cm)
- 1 x Water-proof VGA cable (180 cm)
- 1 x Water-proof USB 2.0 cable (180 cm)

## Power Protection

### DC Version

- OVP (over voltage protection)
- OCP (over current protection)
- SCP (short circuit protection)

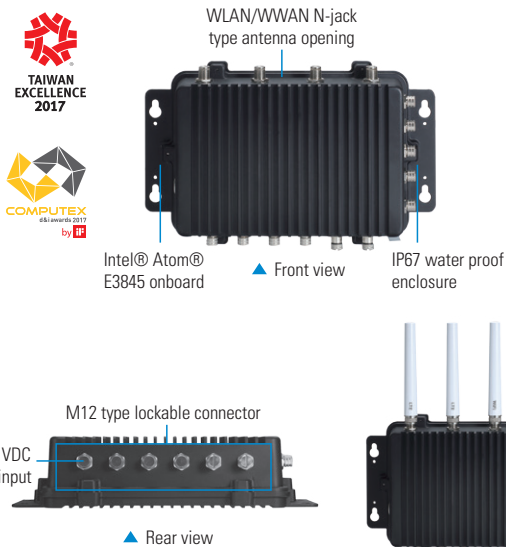

## Ordering Information

### Standard

eBOX800-841-FL-DC	Rugged IP67-rated fanless embedded system with Intel® Atom® E3845 1.91 GHz, VGA, 2 GbE LANs, 2 USB, 2 COM and 9 to 36 VDC
-------------------	---

### Optional

2.5" SATA HDD (W.T.)	80GB or above
2.5" SATA SSD (W.T.)	100GB or above
DDR3L SO-DIMM (W.T.)	2GB to 8GB
CFast™	64GB or above
mSATA	64GB or above
8816K8002A0E	Wi-Fi module
	3G/LTE module
594B8122100E	RS-232 serial cable, 180 cm
594B8152710E	LAN cable, 180 cm
50966224010E	24V 90W M12 power adapter

\* Specifications and certifications may vary based on different requirements.

## Dimensions

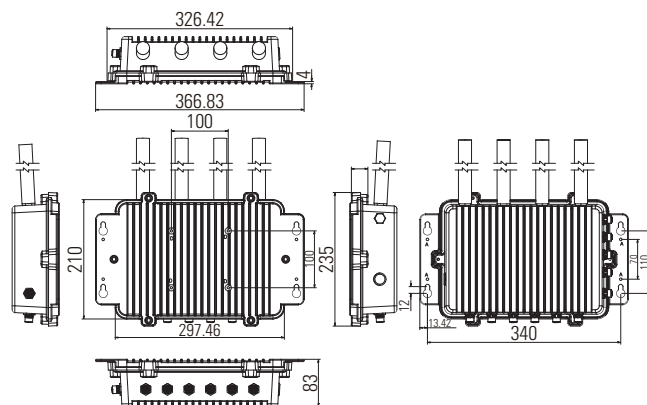



# eBOX800-511-FL NEW

Rugged IP67-rated Fanless Embedded System with Intel® Core™ i5-7300U & Celeron® 3965U, VGA, GbE LAN, 2 USB, 2 COM and 9 to 36 VDC

## Features

- IP67-rating for outdoor use
- Intel® Core™ i5-7300U & Celeron® 3965U onboard
- 4 N-jack antenna openings with water proof design
- 9 to 36 VDC wide range power input
- -30°C to +60°C operating temperature range
- Features M12 lockable I/Os
- Rich I/O options for customized designs and mission-critical projects
- Trusted Platform Module 1.2 (TPM) 1.2



## Specifications

Standard Color	Black
Construction	Aluminum die-casting and heavy-duty steel, IP67
CPU	Intel® Core™ i5-7300U/Celeron® 3965U onboard
System Memory	1 x 260-pin DDR4-2133 SO-DIMM, up to 16GB
Chipset	SoC integrated
BIOS	AMI
System I/O Outlet	2 x RS-232/422/485 (M12) 1 x 10/100/1000 Mbps Ethernet (Intel® i219-LM, M12) 2 x USB 2.0 (M12) 1 x VGA (M12) 1 x 9 to 36VDC power input (M12) 1 x ATX power switch w/indicator 4 x N-jack antenna opening with water proof design
Watchdog Timer	255 levels, 1 to 255 sec.
Storage	1 x 2.5" HDD drive bay (max. up 9.5 mm height) 1 x mSATA (enabled in BIOS setting)
Expansion Interface	1 x Full-size PCI Express Mini Card slot (USB + PCI Express signal) 1 x Half-size PCI Express Mini Card slot (USB + PCI Express signal)
TPM	TPM 1.2
System Indicator	1 x Green LED for system power-on
Power Input	9 to 36 VDC
Operating Temperature	-30°C to +60°C (-22°F to +140°F) (with i5-7300U, W.T. SSD/DRAM)
Humidity	10% to 95% , non-condensing
Vibration Endurance	3 Grms with SSD (5 to 500Hz, X, Y, Z directions)
Dimensions	210 mm (8.27") x 366.83 mm (14.44") x 83 mm (3.27")
Weight (net/gross)	4.31 kg (9.5 lb)/5.1 kg (11.24 lb)
Certifications	CE, FCC Class A
EOS (Support)	Win 10 IoT & Linux , AXView 2.0

\* W.T.: Wide Temperature. All W.T. supported products have to be sorted by Axiomtek.

## Packing List

- 1 x Quick manual
- 1 x Driver CD
- 1 x Water-proof PWR cable (100 cm)
- 1 x Water-proof VGA cable (180 cm)
- 1 x Water-proof USB 2.0 cable (180 cm)

## Power Protection

### DC Version

- OVP (over voltage protection)
- OCV (over current protection)
- SCP (short circuit protection)

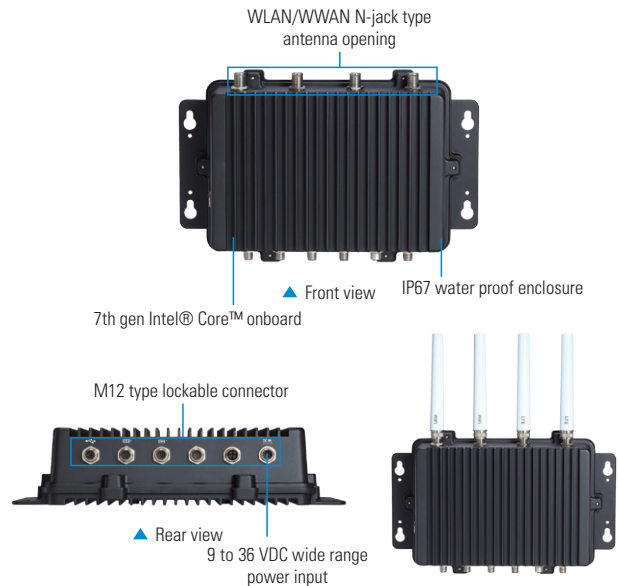

## Ordering Information

### Standard

eBOX800-511-FL-DC-7300U	Rugged IP67-rated Fanless Embedded System with Intel® Core™ i5-7300U, VGA, GbE LAN, 2 USB, 2 COM and 9 to 36 VDC
eBOX800-511-FL-DC-3965U	Rugged IP67-rated Fanless Embedded System with Intel® Celeron® 3965U, VGA, GbE LAN, 2 USB, 2 COM and 9 to 36 VDC

### Optional

2.5" SATA HDD (W.T.)	80GB or above
2.5" SATA SSD (W.T.)	100GB or above
DDR4 SO-DIMM (W.T.)	2GB to 16GB
8816K8002A0E	Wi-Fi module
594B8122100E	3G/LTE module
594B8152710E	RS-232 serial cable, 180 cm
50966224010E	LAN cable, 180 cm
	24V 90W M12 power adapter

\* Specifications and certifications may vary based on different requirements.

## Dimensions

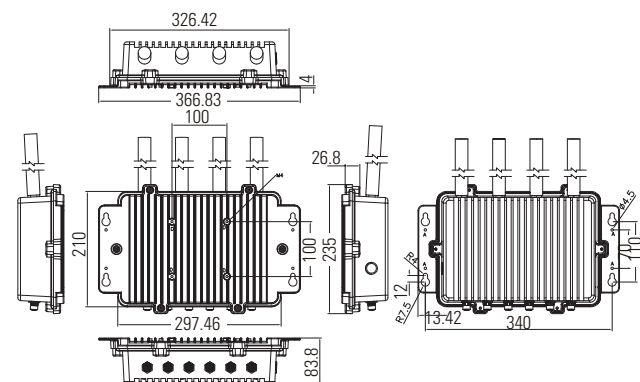

# eBOX800-900-FL NEW

Rugged IP67-rated Fanless Edge System with NVIDIA® Jetson™ TX2, HDMI, GbE LAN, 1-CH PoE, USB 2.0 and 100 to 240 VAC Power Input

## Features

- IP67-rating for outdoor use
- NVIDIA® Jetson™ TX2 with Pascal™, 256 CUDA cores GPU
- High AI computing performance for GPU-accelerated processing
- -30°C to +60°C operating temperature range
- 100 to 240 VAC wide range power input with 10kV surge protection
- 4 N-jack antenna openings with water proof design
- Features M12 lockable I/Os
- 1 IEEE 802.3at Gigabit LAN port (30W)
- Rich I/O options for customized designs and mission-critical projects

NVIDIA TX2 available through to 2022\*  
The official end of life notice will be sent for at least 8 months before the last shipment.



## Specifications

Standard Color	Black
Construction	Aluminum die-casting and heavy-duty steel, IP67
CPU Board	NVIDIA® Jetson™ TX2
CPU	HMP dual Denver 2/2 MB L2 + quad ARM® A57/2 MB L2
GPU	NVIDIA® Pascal™, 256 CUDA cores
System Memory	8GB 128-bit LPDDR4 @ 1866 MHz onboard
Carried Board	SBC87900
System I/O Outlet	1 x C3 USB 2.0 1 x M12 X-Code GbE LAN 1 x M12 X-Code Gigabit PoE (IEEE 802.3at) port (30W) 1 x C3 HDMI with FHD supported 1 x M12 S-Code 3-pos AC in power input 4 x N-jack antenna opening with water proof design
Watchdog Timer	Watchdog timer embedded in NVIDIA® Jetson™ TX2
Storage	Onboard 32GB eMMC (via Jetson™ TX2) 1 x M.2 Key M 2280 with PCIe 2.0 x4 for NVMe SSD (optional)
Wireless Module	802.11ac WLAN, Bluetooth onboard with N-jack type antennas
Expansion Interface	1 x Full-size PCI Express Mini Card slot (USB + PCI Express signal) 1 x SIM slot
TPM	N/A
Power Input	100 to 240 VAC with 10kV SPD
Operating Temperature	-30°C to +60°C (-22°F to +140°F)
Humidity	10% to 95% , non-condensing
Vibration Endurance	3 Grms with SSD (5 to 500Hz, X, Y, Z directions)
Dimensions	210 mm (8.27") x 366.83 mm (14.44") x 83 mm (3.27")
Weight (net/gross)	4.31 kg (9.5 lb)/5.1 kg (11.24 lb)
Certifications	CE, FCC Class A
OS (Support)	Linux ubuntu 16.04

## Packing List

- 1 x Quick manual
- 1 x Screws pack
- 2 x Wi-Fi antennas

## Power Protection

### DC Version

- OVP (over voltage protection)
- OCP (over current protection)
- SCP (short circuit protection)
- SPD (surge protection device)

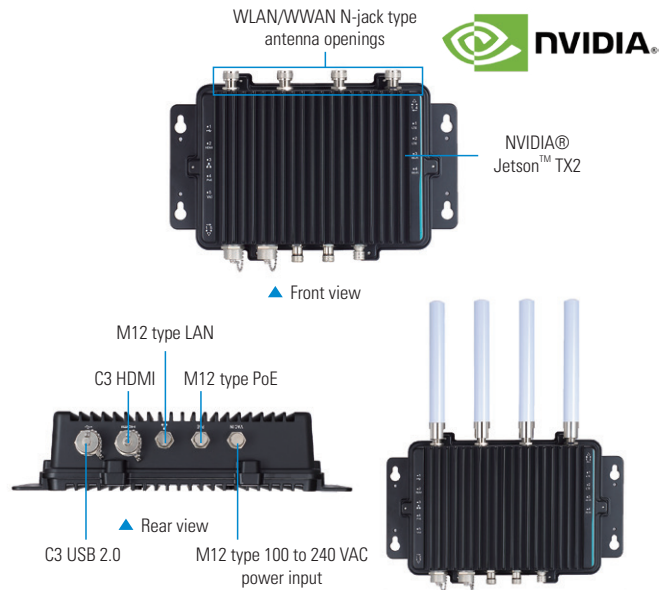

## Ordering Information

### Standard

eBOX800-900-FL	Rugged IP67-rated fanless edge system with NVIDIA® Jetson™ TX2, HDMI, GbE LAN, Gigabit PoE, USB 2.0 and 100 to 240 VAC power input
----------------	--

### Optional

M.2 NVMe	64GB or above
594B8152710E	LAN/PoE cable, 180 cm
594K2303810E	HDMI cable, 100 cm
594K2302810E	USB cable, 200 cm
50966224010E	24V, 90W M12 power adapter
	LTE module

\* Specifications and certifications may vary based on different requirements.

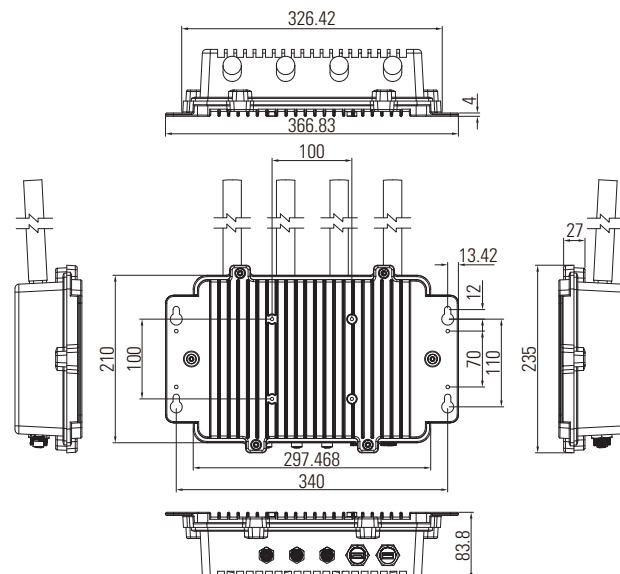

## Dimensions



# 2

## Transportation Embedded Systems

Axiomtek is committed to providing its reliable transportation embedded system for transportation PC applications such as vehicle, railway, marine or other station and facility usage. The stability and reliability of the tBOX series and UST series have helped earn the product an ISO 7637-2 rating and an E-Mark certificate for vehicle applications; meanwhile, the tBOX series has qualified for either EN 50155, EN 50121 and EN 45545 certification for railway applications, or DNV 2.4 for marine applications, and will soon be qualified for IEC 60945 certification for marine applications. The feature-rich tBOX and UST product series offers a variety of desirable features including complete power protection, enhanced flexibility, and customizability. The high quality transportation-certified solutions can help enterprises and individuals improve their operations through the collection and analysis of valuable data for future improvements, also provide seamless communication with GPS, Wi-Fi, 3G/4G and Bluetooth.

Selection Guide		139
tBOX810-838-FL	Fanless Embedded System with Intel® Atom® Processor E3845/E3827 for Vehicle, Railway and Marine PC	141
tBOX100-838-FL	Fanless Embedded System with Intel® Atom® Processor E3845 for Vehicle, Railway and Marine PC	143
tBOX324-894-FL	Fanless Embedded System with 7th Gen Intel® Core™ i7/i5/i3 & Celeron® for Vehicle, Railway and Marine PC	145
 tBOX300-510-FL	Fanless Embedded System with 7th Gen Intel® Core™ i7/i5/i3 & Celeron® Processor for Vehicle, Railway and Marine PC	147
tBOX500-510-FL	Fanless Embedded System with 7th Gen Intel® Core™ i7/i5/i3 & Celeron® Processors for Vehicle, Railway and Marine PC	149
 UST500-517-FL	Fanless Embedded System with 7th/6th Gen Intel® Core™, Pentium® and Celeron® Processor for Vehicle and Railway PC	151

## Systems and Platforms

# Transportation Embedded Systems

## Selection Guide



Features/Models	tBOX810-838-FL	tBOX100-838-FL	tBOX324-894-FL
<b>CPU Level</b>	Intel® Atom® E3845 4C @ 1.91 GHz Intel® Atom® E3827 2C @ 1.75 GHz	Intel® Atom® E3845 4C @ 1.91 GHz	Intel® Core™ i7-7600U 2C @ 2.8 to 3.9 GHz Intel® Core™ i5-7300U 2C @ 2.6 to 3.5 GHz Intel® Core™ i3-7100U 2C @ 2.4 GHz Intel® Celeron® 3965U 2C @ 2.2 GHz
<b>System Memory</b>	DDR3L-1333 4GB DRAM	DDR3L-1333 4GB DRAM	DDR4-1866/2133 32GB DRAM
<b>Chipset</b>	N/A	N/A	N/A
<b>Serial</b>	2 x RS-232/422/485	1 x RS-232/422/485	3 x Isolated RS-232/422/485 (4 x COM optional)
<b>CANbus</b>	N/A (optional by module)	N/A (optional by module)	1 x Isolated CANbus
<b>Display</b>	1 x VGA	1 x VGA	1 x VGA 1 x DVI-I
<b>Audio</b>	N/A (optional by module)	5 x BNC (4 x Video-in & 1 x Audio-in)	2 x Audio (Mic-in & Line-out)
<b>Ethernet</b>	2 x GbE LAN (M12 A-coded/RJ-45 optional)	2 x GbE LAN (M12 A-coded/RJ-45 optional)	4 x GbE LAN (M12 A-coded/RJ-45 optional)
<b>USB</b>	2 x USB 2.0	2 x USB 2.0	4 x USB 3.0
<b>DIO</b>	1 x 8-bit DB9 programmable DIO	N/A	1 x 4-in/4-out isolated DIO
<b>Expansion Interface</b>	2 x Full-size PCI Express Mini Card slot 1 x SIM card slot	1 x Full-size PCI Express Mini Card slot 1 x SIM card slot	3 x Full-size PCI Express Mini Card slot 1 x SIM card slot
<b>Storage</b>	1 x 2.5" SATA HDD/SSD 1 x mSATA	1 x 2.5" SATA HDD/SSD 1 x mSATA	2 x 2.5" SATA HDD/SSD 1 x CFast™
<b>RAID function</b>	N/A	N/A	Intel® RAID 0/1
<b>Watchdog Timer</b>	255 levels, 1 to 255 sec.	255 levels, 1 to 255 sec.	255 levels, 1 to 255 sec.
<b>Power Supply</b>	9 to 36 VDC, typical: 12/24 VDC	9 to 36 VDC, typical: 12/24 VDC	9 to 36 VDC, typical: 12/24 VDC 14 to 32 VDC, typical: 24 VDC 77 to 137.5 VDC, typical: 110 VDC
<b>Operating Temperature</b>	-40°C to +70°C (-40°F to +158°F) (with W.T. SSD)	-40°C to +70°C (-40°F to +158°F) (with W.T. SSD)	-40°C to +70°C (-40°F to +158°F) (with W.T. SSD)
<b>Non-operating Temperature</b>	-40°C to +85°C (-40°F to +185°F)	-40°C to +85°C (-40°F to +185°F)	-40°C to +85°C (-40°F to +185°F)
<b>Mounting</b>	Wall mount DIN-rail	Wall mount DIN-rail	Wall mount DIN-rail
<b>Dimensions (W x D x H)</b>	163.8 x 108 x 44 mm (6.44" x 4.25" x 1.73")	163.8 x 108 x 56.3 mm (6.44" x 4.25" x 2.22")	288.5 x 211.3 x 85.75 mm (11.36" x 8.32" x 3.38")
<b>Weight (net/gross)</b>	0.77 kg (1.69 lb)/1.25 kg (2.76 lb)	0.77 kg (1.69 lb)/1.40 kg (3.09 lb)	5 kg (11 lb)/6.5 kg (14.33 lb)
<b>Certifications</b>	CE (Class A), EN 50155, EN 50121, E-Mark, ISO 7637-2, IEC 60945 and DNV 2.4 certified	CE (Class A) certified E-Mark, ISO 7637-2 EN 50155 and EN 50121-3-2 compliant	CE (Class A), FCC, EN 50155, EN 50121-3-2, E-Mark and ISO 7637-2, EN 45545-2, DNV 2.4 and IEC 60945 certified
<b>EOS Support</b>	Windows® 10, WE8S, WES 7, Linux, VxWorks 7	Windows® 10, WE8S, WES 7, Linux, VxWorks 7	Windows® 10, Linux

NEW



NEW



Features/Models	tBOX300-510-FL	tBOX500-510-FL	UST500-517-FL
<b>CPU Level</b>	Intel® Core™ i7-7600U 2C @ 2.8 GHz Intel® Core™ i5-7300U 2C @ 2.6 GHz Intel® Core™ i3-7100U 2C @ 2.4 GHz Intel® Celeron® 3965U 2C @ 2.2 GHz	Intel® Core™ i7-7600U 2C @ 2.8 GHz Intel® Core™ i5-7300U 2C @ 2.6 GHz Intel® Core™ i3-7100U 2C @ 2.4 GHz Intel® Celeron® 3965U 2C @ 2.2 GHz	7th gen Intel® Core™, 35 to 65W 6th gen Intel® Core™, 35W Intel® Pentium® G4400TE 2.4 GHz, 35W Intel® Celeron® G3900TE 2.3 GHz, 35W
<b>System Memory</b>	DDR4-1866/2133 32GB DRAM	DDR4-1866/2133 32GB DRAM	DDR4-2133/2400 64GB DRAM
<b>Chipset</b>	N/A	N/A	Intel® Q170
<b>Serial</b>	1 x RS-232/422/485	1 x RS-232/422/485	2 x RS-232/422/485
<b>CANbus</b>	N/A	N/A	N/A
<b>Display</b>	1 X DVI-I	1 X DVI-I	1 x DVI-D 1 x VGA 1 x HDMI
<b>Audio</b>	2 x Audio (Mic-in & Line-out)	2 x Audio (Mic-in & Line-out)	2 x Audio (Mic-in & Line-out)
<b>Ethernet</b>	1 x GbE LAN	1 x GbE LAN	8 x RJ-45 (E-Mark) 16 x RJ-45 (E-Mark) 8 x M12 A-coded (EN 50155)
<b>USB</b>	4 x USB 3.0	4 x USB 3.0	4 x USB 3.0
<b>DIO</b>	N/A	N/A	1 x 6-in/2-out isolated DIO
<b>Expansion Interface</b>	3 x Full-size PCI Express Mini Card slot 2 x SIM card slot 1 x Value-added module slot	3 x Full-size PCI Express Mini Card slot 2 x SIM card slot 2 x Value-added module slot	2 x Full-size & 2 x half-size PCI Express Mini Card slot 2 x External accessible SIM card slot
<b>Storage</b>	4 x 2.5" SATA HDD/SSD 1 x mSATA	2 x 2.5" SATA HDD/SSD 1 x mSATA	2 or 4 x 2.5" 15 mm SATA HDD/SSD 1 x mSATA
<b>RAID Function</b>	Marvell HW RAID 0/1/10	Intel® RAID 0/1	Intel® RAID 0/1/5/10
<b>Watchdog Timer</b>	255 levels, 1 to 255 sec.	255 levels, 1 to 255 sec.	255 levels, 1 to 255 sec.
<b>Power Supply</b>	9 to 36 VDC, typical: 12/24VDC 16.8 to 137.5 VDC, typical: 24/48/72/96/110 VDC	9 to 36 VDC, typical: 12/24VDC 16.8 to 137.5 VDC, typical: 24/48/72/96/110 VDC	9 to 36 VDC, typical: 24 VDC
<b>Operating Temperature</b>	-25°C to +70°C (-13°F to +158°F) (with W.T. SSD)	-40°C to +70°C (-40°F to +158°F) (with W.T. SSD)	-40°C to +70°C (-40°F to +158°F) (with W.T. SSD)
<b>Non-operating Temperature</b>	-25°C to +85°C (-25°F to +185°F)	-40°C to +85°C (-40°F to +185°F)	-40°C to +85°C (-40°F to +185°F)
<b>Mounting</b>	Wall mount	Wall mount	Wall mount
<b>Dimensions (W x D x H)</b>	321 x 210.2 x 105.33 mm (12.64" x 8.28" x 4.15")	321 x 210.2 x 73.3 mm (12.64" x 8.28" x 2.89")	280 x 210.5 x 70 mm (11.02" x 8.27" x 2.76") with 2 SATA (internal accessible) 280 x 210.5 x 99.2 mm (11.02" x 8.29" x 3.9") with 4 SATA
<b>Weight (net/gross)</b>	4.5 kg (9.92 lb)/6 kg (13.23 lb)	3.5 kg (7.72 lb)/4.5 kg (11.02 lb)	3.5 kg (7.72 lb)/4.5 kg (11.02 lb)
<b>Certifications</b>	CE (Class A), FCC, EN 50155, EN 50121-3-2, EN 45545-2, and IEC 60945 certified; E-Mark, ISO 7637-2, and DNV 2.4 compliant	CE (Class A), FCC, EN 50155, EN 50121-3-2, EN 45545-2, and IEC 60945 certified; E-Mark, ISO 7637-2, and DNV 2.4 compliant	CE (Class A), FCC, EN 50155, EN 50121-3-2, E-Mark, ISO 7637-2, EN 45545-2 compliant
<b>EOS Support</b>	Windows® 10, Linux	Windows® 10, Linux	Windows® 7/8/10, Linux *Windows® 7/8 is only available at Skylake processor (6th gen.)

Transportation Embedded Systems

1

2

3

4

5

6

7

8



# tBOX810-838-FL

Fanless Embedded System with Intel® Atom® Processor E3845/E3827 for Vehicle, Railway and Marine PC

## Features

- E-Mark, ISO 7637-2, EN 50155, EN 50121, DNV 2.4 and IEC 60945 certified
- Intel® Atom® processor E3845 or E3827
- DDR3L-1333 4GB memory onboard
- Wide operating temperatures from -40°C to +70°C (EN 50155 class TX)
- Intelligent solution of vehicle power management (ACC ignition)
- Compact size with multiple I/Os
- 2 PCI Express Mini Card slots and 1 SIM card slot



E13/ISO7637



## Specifications

Standard Color	Silver-Black
Construction	Aluminum extrusion and heavy-duty steel, IP40
CPU	Intel® Atom® processor E3845 (4C @ 1.91 GHz) Intel® Atom® processor E3827 (2C @ 1.75 GHz)
System Memory	DDR3L-1333, 4GB memory onboard
Chipset	SoC integrated
BIOS	AMI
System I/O Outlet	Rear Option #1: 2 x M12 A-coded GbE LAN + 1 x M12 DC power input Option #2: 2 x RJ-45 GbE LAN + 1 x Phoenix DC power input 4 x Antenna opening Front 2 x RS-232/422/485 1 x DI/DO (8-bit programmable) 2 x VGA 2 x USB 2.0 1 x Remote switch 1 x Reset button
Watchdog Timer	255 levels, 1 to 255 sec.
Storage	1 x 2.5" SATA drive (9.5 mm height) 1 x mSATA
RAID function	N/A
Expansion Interface	2 x Full-size PCI Express Mini Card slot 1 x mSATA (use 1 PCI Express Card slot) 1 x SIM card slot
System Indicator	1 x Green LED indicator for system power 1 x Green LED indicator for programmable #1 1 x Green LED indicator for programmable #2 1 x Yellow LED indicator for HDD active 1 x Green LED indicator for LAN #1 active 1 x Green LED indicator for LAN #2 active
Power Supply	9 to 36 VDC, typical: 12/24 VDC 14 to 32 VDC, typical: 24 VDC
Operating Temperature	-40°C to +70°C (-40°F to +158°F) with W.T. SSD -25°C to +55°C (-13°F to +131°F) with W.T. HDD
Humidity	5% to 95%, non-condensing
Vibration Endurance	3 Grms w/ SSD (5 to 500Hz, X, Y, Z direction; random) 1 Grms w/ HDD (5 to 500Hz, X, Y, Z direction; random)
Shock	Comply EN 61373 section 10 table 3 category 1 class A and class B up to 5 Grms (30ms, ±X/Y/Z direction)
Dimensions	163.8 mm (6.44") (W) x 108 mm (4.25") (D) x 44 mm (1.73") (H)
Weight (net/gross)	0.77 kg (1.69 lb)/1.25 kg (2.76 lb)
Certifications	CE (Class A), EN 50155, EN 50121, E-Mark, ISO 7637-2, IEC 60945, DNV 2.4 certified
EOS support	Windows® 10, WE8S, WES 7, Linux, VxWorks7



▲ Front view



▲ Rear view

## Ordering Information

Standard	
tBOX810-838-FL-E3827-RJ-DC (P/N: E26N810105)	Fanless vehicle/railway/marine embedded system with Intel® Atom® processor E3827, 4GB DRAM, 2 GbE LANs (RJ-45), phoenix DC-in, 2 USB, VGA, 2 COM, DIO and ACC ignition (vehicle only)
tBOX810-838-FL-E3827-M12-ACC-DC (P/N: E26N810102)	Fanless vehicle/railway/marine embedded system with Intel® Atom® processor E3827, 4GB DRAM, 2 GbE LANs (M12), M12 DC-in, 2 USB, VGA, 2 COM, DIO and ACC ignition (vehicle only)
tBOX810-838-FL-E3827-M12-RL-DC (P/N: E26N810107)	Fanless vehicle/railway/marine embedded system with Intel® Atom® processor E3827, 4GB DRAM, 2 GbE LANs (M12), M12 DC-in, 2 USB, VGA, 2 COM and DIO (railway & marine only)
tBOX810-838-FL-E3845-RJ-DC (P/N: E26N810104)	Fanless vehicle/railway/marine embedded system with Intel® Atom® processor E3845, 4GB DRAM, 2 GbE LANs (RJ-45), phoenix DC-in, 2 USB, VGA, 2 COM, DIO and ACC ignition (vehicle only)
tBOX810-838-FL-E3845-RJ-AUDIO-DC (P/N: E26N810110)	Fanless vehicle/railway/marine embedded system with Intel® Atom® processor E3845, 4GB DRAM, 2 GbE LANs (RJ-45), phoenix DC-in, 2 USB, VGA, 2 COM, DIO, audio and ACC ignition (vehicle only)
tBOX810-838-FL-E3845-M12-ACC-DC (P/N: E26N810100)	Fanless vehicle/railway/marine embedded system with Intel® Atom® processor E3845, 4GB DRAM, 2 GbE LANs (M12), M12 DC-in, 2 USB, VGA, 2 COM, DIO and ACC ignition (vehicle only)
tBOX810-838-FL-E3845-M12-RL-DC (P/N: E26N810106)	Fanless vehicle/railway/marine embedded system with Intel® Atom® processor E3845, 4GB DRAM, 2 GbE LANs (M12), M12 DC-in, 2 USB, VGA, 2 COM and DIO (railway & marine only)
tBOX810-838-FL-E3845-M12-AUDIO-DC (P/N: E26N810109)	Fanless vehicle/railway/marine embedded system with Intel® Atom® processor E3845, 4GB DRAM, 2 GbE LANs (M12), M12 DC-in, 2 USB, VGA, 2 COM, DIO and audio (railway & marine only)
tBOX810-838-FL-E3845-RJ-Marine-DC (P/N: E26N810114)	Fanless marine grade embedded system with Intel® Atom® processor E3845, 4GB DRAM, 2 GbE LANs (RJ-45), phoenix DC-in, 2 USB, VGA, 2 COM, DIO and audio (marine only)
tBOX810-838-FL-E3827-RJ-Marine-DC (P/N: E26N810115)	Fanless marine grade embedded system with Intel® Atom® processor E3827, 4GB DRAM, 2 GbE LANs (RJ-45), phoenix DC-in, 2 USB, VGA, 2 COM, DIO and audio (marine only)

Optional	
2.5" SATA HDD/SSD	16GB or above
mSATA	16GB or above
3G/4G/GPS module	826N3230130E, 826N3230140E, 826N8101040E, 826N8101030E, 826N8101020E
Wi-Fi/Bluetooth module	826K6231010E, 826K3101060E, 826N3230110E, 826N3230100E, 826N3230120E
DC in cable	594B8120B30E (M12-wire, w/o ACC), 594B7100B00E (M12-wire, w/ ACC)

LAN cable	594N3202730E (M12-A male 8P to RJ-45)
Remote switch cable	594K3101020E
AC to DC adapter	50957245000E (24V/90W, WIRE), 50906D24000E (24V/120W, WIRE), 50966D45010E (24V/120W, M12)
Power cord	59903000000E (EU), 59906000010E (JP), 59902000000E (US), 59904000000E (UK)
CANbus module	E392903100 (AX92903)
Audio module	E392905100 (AX92905)

\*Specifications and certifications may vary based on different requirements.

## Expansion & Installation



Slim and compact size of 163.8 x 108 x 44 mm



Great expandability with 2 PCI Express Mini Card slot + 1 SIM card slot



Optional I/O ports for audio, LAN jack type and DC-in jack type



Onboard processor and system memory for great reliability and stability



Easy storage maintenance



DIN-rail, wall mount supported for various applications

## Packing List

- 1 x Quick manual
- 1 x Driver CD
- 1 x Screw pack
- 4 x Foot pad
- 1 x Wall mount
- 1 x DIN-rail kit

## Power Protection

### DC Version

- SCP (short circuit protection)
- OVP (over voltage protection)
- UVP (under voltage protection)
- RVP (reverse voltage protection)

### Vehicle Version

- ISO 7637-2 pulse 1/2/3/4
- Battery protection setting: Low voltage, Very low voltage
- Ignition control setting: Low voltage counter, ACC-ON delay, Shut down delay

## Dimensions

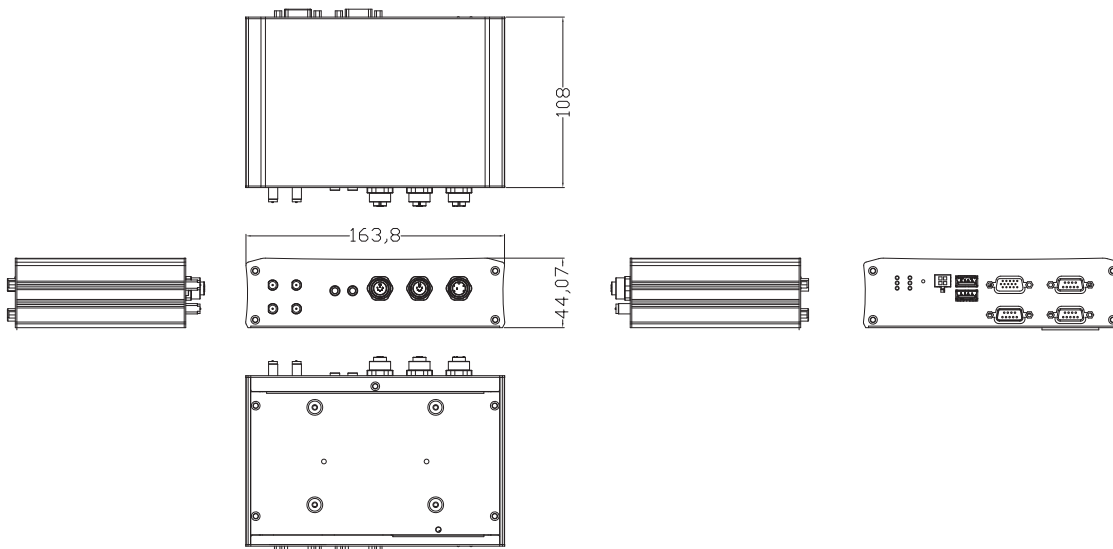

# tBOX100-838-FL

Fanless Embedded System with Intel® Atom® Processor E3845 for Vehicle, Railway and Marine PC

## Features

- CE (Class A) certified, E-Mark, ISO 7637-2 EN 50155, EN 50121, DNV 2.4 and IEC 60945 compliant
- Intel® Atom® processor E3845 4C @ 1.91 GHz
- 4GB DDR3L-1333 memory onboard
- Wide operating temperatures from -40°C to +60°C
- Intelligent solution of vehicle power management (ACC ignition)
- Compact size with multiple I/Os
- 1 PCI Express Mini Card slot and 1 SIM card slot

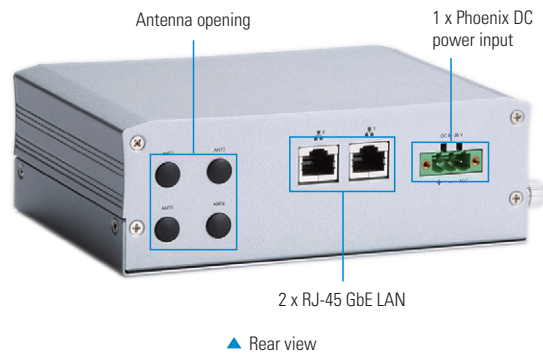
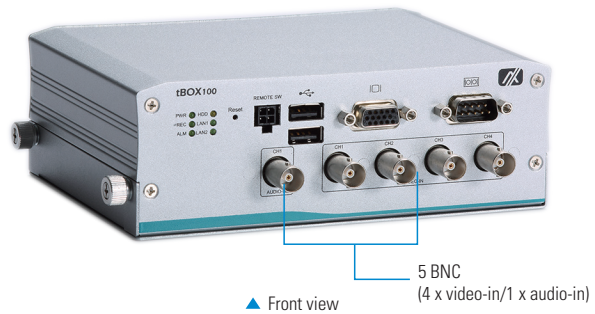

## Specifications

Standard Color	Silver				
Construction	Aluminum extrusion and heavy-duty steel, IP40				
CPU	Intel® Atom® processor E3845 (4C @ 1.91 GHz)				
System Memory	DDR3L-1333, 4GB memory onboard				
Chipset	SoC integrated				
BIOS	AMI				
System I/O Outlet	<table border="0"> <tr> <td>Rear</td> <td>                     Option #1: 2 x M12 A-coded GbE LAN +                      1 x M12 DC power input                      Option #2: 2 x RJ-45 GbE LAN +                      1 x Phoenix DC power input                      4 x Antenna opening                 </td> </tr> <tr> <td>Front</td> <td>                     1 x RS-232/422/485                      1 x VGA                      2 x USB 2.0                      1 x Remote switch                      1 x Reset button                      5 x BNC (4 x video-in/1 x audio-in)                 </td> </tr> </table>	Rear	Option #1: 2 x M12 A-coded GbE LAN + 1 x M12 DC power input Option #2: 2 x RJ-45 GbE LAN + 1 x Phoenix DC power input 4 x Antenna opening	Front	1 x RS-232/422/485 1 x VGA 2 x USB 2.0 1 x Remote switch 1 x Reset button 5 x BNC (4 x video-in/1 x audio-in)
Rear	Option #1: 2 x M12 A-coded GbE LAN + 1 x M12 DC power input Option #2: 2 x RJ-45 GbE LAN + 1 x Phoenix DC power input 4 x Antenna opening				
Front	1 x RS-232/422/485 1 x VGA 2 x USB 2.0 1 x Remote switch 1 x Reset button 5 x BNC (4 x video-in/1 x audio-in)				
Watchdog Timer	255 levels, 1 to 255 sec.				
Storage	1 x 2.5" SATA drive (9.5 mm height)				
RAID function	N/A				
Expansion Interface	1 x Full-size PCI Express Mini Card slot 1 x SIM card slot				
System Indicator	1 x Green LED indicator for system power 1 x Green LED indicator for programmable #1 1 x Green LED indicator for programmable #2 1 x Yellow LED indicator for HDD active 1 x Green LED indicator for LAN #1 active 1 x Green LED indicator for LAN #2 active				
Power Supply	9 to 36 VDC, typical: 12/24 VDC 14 to 32 VDC, typical: 24 VDC				
Operating Temperature	-40°C to +60°C (-40°F to +140°F) with W.T. SSD -25°C to +55°C (-13°F to +131°F) with W.T. HDD				
Humidity	5% to 95%, non-condensing				

Vibration Endurance	2 Grms w/ SSD (5 to 500Hz, X, Y, Z direction; random) 1 Grms w/ HDD (5 to 500Hz, X, Y, Z direction; random)
Shock	Comply EN 61373 section 10 table 3 category 1 class A and class B up to 5 Grms (30ms, ±X/Y/Z direction)
Dimensions	163.8 mm (6.44") (W) x 108 mm (4.25") (D) x 56.3 mm (2.22") (H)
Weight (net/gross)	0.77 kg (1.69 lb)/1.40 kg (3.09 lb)
Certifications	CE (Class A) certified, E-Mark, ISO 7637-2 EN 50155, EN 50121, DNV 2.4 and IEC 60945 compliant
EOS support	Windows® 10, WE8S, WES 7, Linux, VxWorks7

## Ordering Information

Standard	
tBOX100-838-FL-E3845-RJ-ACC-DC (P/N: E26N100100)	Fanless vehicle embedded system with Intel® Atom® processor E3845, 4GB RAM, 2 GbE LANs (RJ-45), phoenix DC-in, COM, 5 BNC (4 x video-in/1 x audio-in), capture card and ACC ignition
tBOX100-838-FL-E3845-24MRDC	Fanless railway embedded system with Intel® Atom® processor E3845, 4GB RAM, 2 GbE LANs (M12), M12 DC-in, COM, 5 BNC (4 x video-in/1 x audio-in) and capture card

### Optional

- 2.5" SATA HDD/SSD
- 3G/4G/GPS module
- Wi-Fi/Bluetooth module
- PCI Express Mini Card
- Remote switch cable
- M12 LAN cable
- M12 power cable

\*Specifications and certifications may vary based on different requirements.

## Expansion & Installation



5 BNC connectors (4 x video-in/1 x audio-in) for DVR surveillance system



1 swappable 2.5" SATA HDD/SSD



1 PCI Express Video Capture Card  
1 PCI Express Mini Card slot + 1 SIM card slot

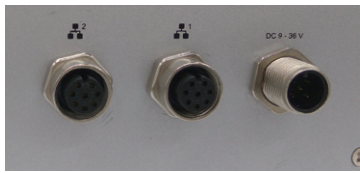

Optional M12 connectors for DC-in and LAN jacks



Onboard processor and system memory for great reliability and stability



DIN-rail, wall mount supported for various applications

## Packing List

- 1 x Quick manual
- 1 x Driver CD
- 1 x Screws pack
- 4 x Foot pad
- 1 x Wall mount Kit
- 1 x DIN-rail Kit
- 1 x DIO female connector (Optional)

## Power Protection

- SCP (short circuit protection)
- OVP (over voltage protection)
- UVP (under voltage protection)
- RVP (reverse voltage protection)

### Vehicle Version

- ISO 7637-2 pulse 1/2/3/4
- Battery protection setting: Low voltage, very low voltage
- Ignition control setting: Low voltage counter, ACC-ON delay, shut down delay

## Dimensions

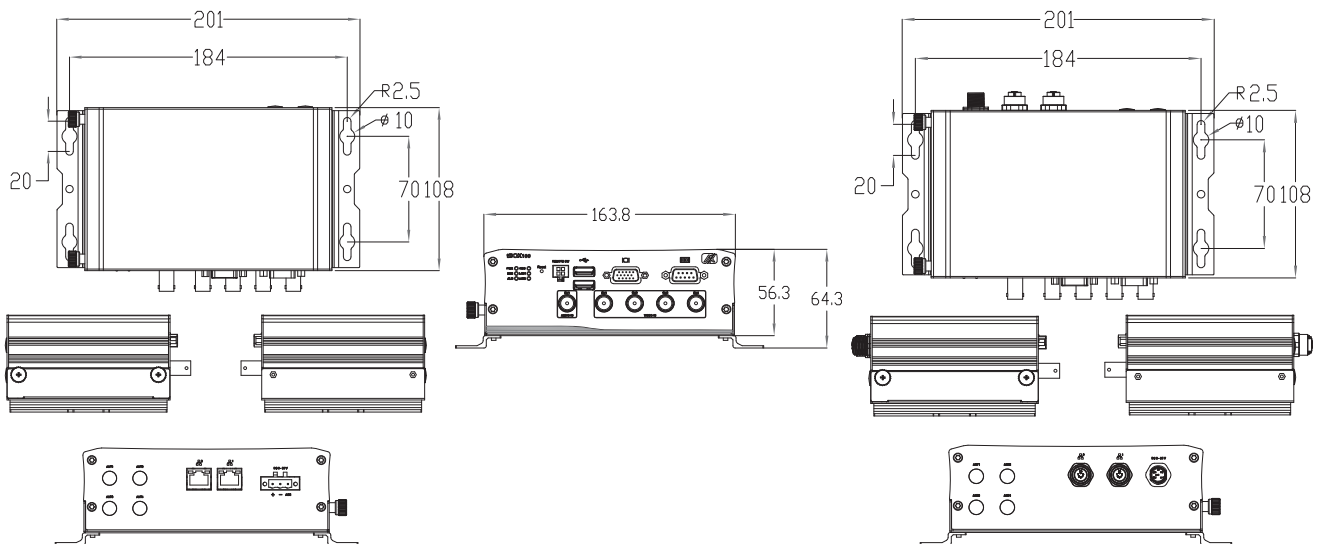



# tBOX324-894-FL

Fanless Embedded System with 7th Gen Intel® Core™ i7/i5/i3 & Celeron® Processor for Vehicle, Railway and Marine PC

## Features

- CE (Class A), EN 50155, EN 50121-3-2, E-Mark, ISO 7637-2, IEC 60945 and DNV 2.4 certified
- 7th gen Intel® Core™ i7/i5/i3 & Celeron® processors
- 2 DDR4-1866/2133 SO-DIMM up to 32GB
- Typical 12/24/110 VDC power input
- Wide operating temperatures from -40°C to +70°C
- Intelligent solution of vehicle power management (ACC ignition)
- 2 swappable 2.5" SATA drives
- 3 PCI Express Mini Card slots and 1 SIM card slot



## Specifications

Standard Color	Silver black				
Construction	Aluminum extrusion and heavy-duty steel, IP40				
CPU	Intel® Core™ i7-7600U 2C @ 2.8 to 3.9 GHz Intel® Core™ i5-7300U 2C @ 2.6 to 3.5 GHz Intel® Core™ i3-7100U 2C @ 2.4 GHz Intel® Celeron® 3965U 2C @ 2.2 GHz				
System Memory	2 x DDR4-1866/2133 SO-DIMM, up to 32GB				
Chipset	SoC integrated				
BIOS	AMI				
System I/O Outlet	<table border="0"> <tr> <td>Rear</td> <td> <ul style="list-style-type: none"> <li>1 x M12 (5P)/TB (3P) power connector</li> <li>1 x Isolated RS-232/422/485 (DB9)</li> <li>1 x Isolated CANbus 2.0 A/B (DB9) or RS-232/422/485 (optional)</li> <li>2 x Isolated RS-232/422/485 (TB 2 x 5P)</li> <li>1 x 4-in/4-out isolated DIO (TB 2 x 6P)</li> <li>1 x DVI-I (supports DVI &amp; VGA)</li> <li>1 x VGA</li> <li>1 x Remote switch</li> <li>2 x Audio (Mic-in &amp; Line-out)</li> <li>4 x RJ-45/M12 A-coded GbE LAN</li> <li>3 x Antenna opening</li> </ul> </td> </tr> <tr> <td>Front</td> <td> <ul style="list-style-type: none"> <li>8 x LED indicator for LAN link/activity</li> <li>1 x LED indicator for SATA drive activity</li> <li>1 x LED indicator for power</li> <li>4 x USB 3.0</li> <li>1 x CFast™</li> <li>1 x Reset button</li> <li>2 x 2.5" SATA drive tray</li> </ul> </td> </tr> </table>	Rear	<ul style="list-style-type: none"> <li>1 x M12 (5P)/TB (3P) power connector</li> <li>1 x Isolated RS-232/422/485 (DB9)</li> <li>1 x Isolated CANbus 2.0 A/B (DB9) or RS-232/422/485 (optional)</li> <li>2 x Isolated RS-232/422/485 (TB 2 x 5P)</li> <li>1 x 4-in/4-out isolated DIO (TB 2 x 6P)</li> <li>1 x DVI-I (supports DVI &amp; VGA)</li> <li>1 x VGA</li> <li>1 x Remote switch</li> <li>2 x Audio (Mic-in &amp; Line-out)</li> <li>4 x RJ-45/M12 A-coded GbE LAN</li> <li>3 x Antenna opening</li> </ul>	Front	<ul style="list-style-type: none"> <li>8 x LED indicator for LAN link/activity</li> <li>1 x LED indicator for SATA drive activity</li> <li>1 x LED indicator for power</li> <li>4 x USB 3.0</li> <li>1 x CFast™</li> <li>1 x Reset button</li> <li>2 x 2.5" SATA drive tray</li> </ul>
Rear	<ul style="list-style-type: none"> <li>1 x M12 (5P)/TB (3P) power connector</li> <li>1 x Isolated RS-232/422/485 (DB9)</li> <li>1 x Isolated CANbus 2.0 A/B (DB9) or RS-232/422/485 (optional)</li> <li>2 x Isolated RS-232/422/485 (TB 2 x 5P)</li> <li>1 x 4-in/4-out isolated DIO (TB 2 x 6P)</li> <li>1 x DVI-I (supports DVI &amp; VGA)</li> <li>1 x VGA</li> <li>1 x Remote switch</li> <li>2 x Audio (Mic-in &amp; Line-out)</li> <li>4 x RJ-45/M12 A-coded GbE LAN</li> <li>3 x Antenna opening</li> </ul>				
Front	<ul style="list-style-type: none"> <li>8 x LED indicator for LAN link/activity</li> <li>1 x LED indicator for SATA drive activity</li> <li>1 x LED indicator for power</li> <li>4 x USB 3.0</li> <li>1 x CFast™</li> <li>1 x Reset button</li> <li>2 x 2.5" SATA drive tray</li> </ul>				
Watchdog Timer	255 levels, 1 to 255 sec.				
Storage	2 x 2.5" SATA drive (9.5 mm height) 1 x CFast™				
RAID function	Intel® RAID Q/1				
Expansion Interface	3 x Full-size PCI Express Mini Card slot 1 x SIM card slot				
System Indicator	1 x LED indicator for system power 1 x LED indicator for SATA drive active 4 x LED indicator for LAN activated 4 x LED indicator for LAN linked				
Power Supply	Railway version DC-input: 24/110 VDC (tolerance: 14 to 32 VDC/77 to 137.5 VDC) Vehicle version DC-input: 12/24 VDC (tolerance: 9 to 36 VDC, with ACC ignition) Marine version DC-input: 24 VDC (tolerance: 14 to 32VDC)				
Operating Temperature	-40°C to +70°C (-40°F to +158°F) with W.T. SSD 0°C to +55°C (+32°F to +131°F) with HDD				
Humidity	10% to 95%, non-condensing				
Vibration Endurance	3 Gms w/ SSD, 1 Gms w/ HDD (5 to 500Hz, X/Y/Z direction; random) EN 61373 cat. 1 class B IEC 60068-2-64 MIL-STD-810G, Method 514.6C, Procedure I, Category 4				



▲ Front view



▲ Rear view

Shock (non-operating test)	Shock optioning, 50 Grms, Half-sine 11 ms Duration (w/ SSD, according to IEC60068-2-27)
Dimensions	288.5 mm (11.36") (W) x 211.3 mm (8.32") (D) x 85.75 mm (3.38") (H)
Weight	5 kg (11 lb)/6.5 kg (14.33 lb)
Certifications	CE (Class A), FCC, EN 50155, EN 50121-3-2, E-Mark, ISO 7637-2, DNV 2.4, IEC 60945 and EN 45545-2 certified
EOS support	Windows® 10 64-bit, Linux

## Ordering Information

Standard	
tBOX324-894-FL-Celeron-DIO-24MRDC-CAN (P/N: E26N324100)	Fanless railway embedded system with Intel® Celeron® 3965U 2.2 GHz processor, 4 USB, VGA, DVI-I, 4 GbE LANs (M12), 3 COM, CAN, DIO, two 2.5" SATA trays, M12 A-code 5P DC-in, and 14 to 32 VDC
tBOX324-894-FL-i3-DIO-24MRDC-CAN (P/N: E26N324101)	Fanless railway embedded system with Intel® Core™ i3-7100U 2.4 GHz processor, 4 USB, VGA, DVI-I, 4 GbE LANs (M12), 3 COM, CAN, DIO, two 2.5" SATA trays, M12 A-code 5P DC-in, and 14 to 32 VDC
tBOX324-894-FL-i5-DIO-24MRDC-CAN (P/N: E26N324102)	Fanless railway embedded system with Intel® Core™ i5-7300U 2.6 to 3.5 GHz processor, 4 USB, VGA, DVI-I, 4 GbE LANs (M12), 3 COM, CAN, DIO, two 2.5" SATA trays, M12 A-code 5P DC-in, and 14 to 32 VDC
tBOX324-894-FL-i7-DIO-24MRDC-CAN (P/N: E26N324103)	Fanless railway embedded system with Intel® Core™ i7-7600U 2.8 to 3.9 GHz processor, 4 USB, VGA, DVI-I, 4 GbE LANs (M12), 3 COM, CAN, DIO, two 2.5" SATA trays, M12 A-code 5P DC-in, and 14 to 32 VDC
tBOX324-894-FL-Celeron-DIO-TMDC-CAN-GND (P/N: E26N324113)	Fanless marine embedded system with Intel® Celeron® 3965U 2.2 GHz processor, 4 USB, VGA, DVI-I, 4 GbE LANs (RJ-45), 3 COM, CAN, DIO, two 2.5" SATA trays, TB 3P DC-in with GND, 14 to 32 VDC
tBOX324-894-FL-i3-DIO-TMDC-CAN-GND (P/N: E26N324114)	Fanless marine embedded system with Intel® Core™ i3-7100U 3965U 2.2 GHz processor, 4 USB, VGA, DVI-I, 4 GbE LANs (RJ-45), 3 COM, CAN, DIO, two 2.5" SATA trays, TB 3P DC-in with GND, 14 to 32 VDC
tBOX324-894-FL-i5-DIO-TMDC-CAN-GND (P/N: E26N324115)	Fanless marine embedded system with Intel® Core™ i5-7300U 3965U 2.2 GHz processor, 4 USB, VGA, DVI-I, 4 GbE LANs (RJ-45), 3 COM, CAN, DIO, two 2.5" SATA trays, TB 3P DC-in with GND, 14 to 32 VDC
tBOX324-894-FL-i7-DIO-TMDC-CAN-GND (P/N: E26N324117)	Fanless marine embedded system with Intel® Core™ i7-7600U 3965U 2.2 GHz processor, 4 USB, VGA, DVI-I, 4 GbE LANs (RJ-45), 3 COM, CAN, DIO, two 2.5" SATA trays, TB 3P DC-in with GND, 14 to 32 VDC
tBOX324-894-FL-Celeron-DIO-TVDC-CAN-GND (P/N: E26N324109)	Fanless vehicle embedded system with Intel® Celeron® 3965U 2.2 GHz processor, 4 USB, VGA, DVI-I, 4 GbE LANs (RJ-45), 3 COM, CAN, DIO, two 2.5" SATA trays, 9 to 36 VDC, TB 3P DC-in, and ACC ignition
tBOX324-894-FL-i3-DIO-TVDC-CAN-GND (P/N: E26N324110)	Fanless vehicle embedded system with Intel® Core™ i3-7100U 2.4 GHz processor, 4 USB, VGA, DVI-I, 4 GbE LANs (RJ-45), 3 COM, CAN, DIO, two 2.5" SATA trays, 9 to 36 VDC, TB 3P DC-in, and ACC ignition
tBOX324-894-FL-i5-DIO-TVDC-CAN-GND (P/N: E26N324111)	Fanless vehicle embedded system with Intel® Core™ i5-7300U 2.6 to 3.5 GHz processor, 4 USB, VGA, DVI-I, 4 GbE LANs (RJ-45), 3 COM, CAN, DIO, two 2.5" SATA trays, 9 to 36 VDC, TB 3P DC-in, and ACC ignition
tBOX324-894-FL-i7-DIO-TVDC-CAN-GND (P/N: E26N324112)	Fanless vehicle embedded system with Intel® Core™ i7-7600U 2.8 to 3.9 GHz processor, 4 USB, VGA, DVI-I, 4 GbE LANs (RJ-45), 3 COM, CAN, DIO, 9 to 36 VDC, two 2.5" SATA trays, TB 3P DC-in, and ACC ignition



tBOX324-894-FL-Celeron-DIO-110MRDC-CAN-GND (P/N: E26N324118)	Fanless railway embedded system with Intel® Celeron® 3965U 2.2 GHz processor, 4 USB, VGA, DVI-I, 4 GbE LANs (M12), 3 COM, CAN, DIO, two 2.5" SATA trays, M12 A-code 5P DC-in with GND, and 77 to 137.5 VDC
tBOX324-894-FL-i3-DIO-110MRDC-CAN-GND (P/N: E26N324119)	Fanless railway embedded system with Intel® Core™ i3-7100U 2.4 GHz processor, 4 USB, VGA, DVI-I, 4 GbE LANs (M12), 3 COM, CAN, DIO, two 2.5" SATA trays, M12 A-code 5P DC-in with GND, and 77 to 137.5 VDC
tBOX324-894-FL-i5-DIO-110MRDC-CAN-GND (P/N: E26N324120)	Fanless railway grade embedded system with Intel® Core™ i5-7300U 2.6 to 3.5 GHz processor, 4 USB, VGA, DVI-I, 4 GbE LANs (M12), 3 COM, CAN, DIO, two 2.5" SATA trays, M12 A-code 5P DC-in with GND, and 77 to 137.5 VDC
tBOX324-894-FL-i7-DIO-110MRDC-CAN-GND (P/N: E26N324121)	Fanless railway embedded system with Intel® Core™ i7-7600U 2.8 to 3.9 GHz processor, 4 USB, VGA, DVI-I, 4 GbE LANs (M12), 3 COM, CAN, DIO, two 2.5" SATA trays, M12 A-code 5P DC-in with GND, and 77 to 137.5 VDC

\*MRDC: M12 DC-IN connector, Railway SKU, DC voltage input  
 \*TVDC: Terminal Block DC-IN connector, Vehicle SKU, DC voltage input  
 \*TMDC: Terminal Block DC-IN connector, Marine SKU, DC voltage input

Optional	
2.5" SATA HDD/SSD	64GB or above
CFast	64GB or above
DDR4 SO-DIMM	4GB to 16GB
3G/4G/GPS module	826N3230140E
Wi-Fi/Bluetooth module	826N3230110E
DC in cable	594B8120B30E (M12, w/o ACC)
Remote switch cable	594K3101020E
LAN cable	594N3202730E (M12-A male 8P to RJ-45)
AC to DC adapter	50906D24000E (24V/120W, WIRE), 50966224010E (24V 90W, M12 Acode 5P)
Power cord	59903000000E (EU), 59906000010E (JP), 59902000000E (US), 59904000000E(UK)

\*Specifications and certifications may vary based on different requirements.

## Expansion & Installation

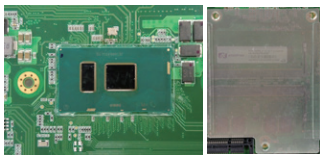

Onboard processor design and unique thermal/fasten plate on the system memory for great reliability



2 swappable and lockable 2.5" SATA3 HDD/SSD and 1 CFastTM



Optional M12 connectors for DC-in and LAN jacks



DVI-I and VGA ports

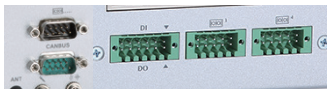

1 COM (DB9), 1 CANbus/COM (DB9), 1 DIO (TB) and 2 COM (TB)



3 Full-size PCI Express Mini Card slots and 1 SIM card slot

## Packing List

- 1 x Quick installation guide
- 1 x Driver CD
- 4 x Foot pad
- 1 x Screw pack
- 1 x Wall mount kit
- 4 x DRAM thermal pad
- 1 x Terminal block DC In connector
- 2 x SATA drive key

## Dimensions

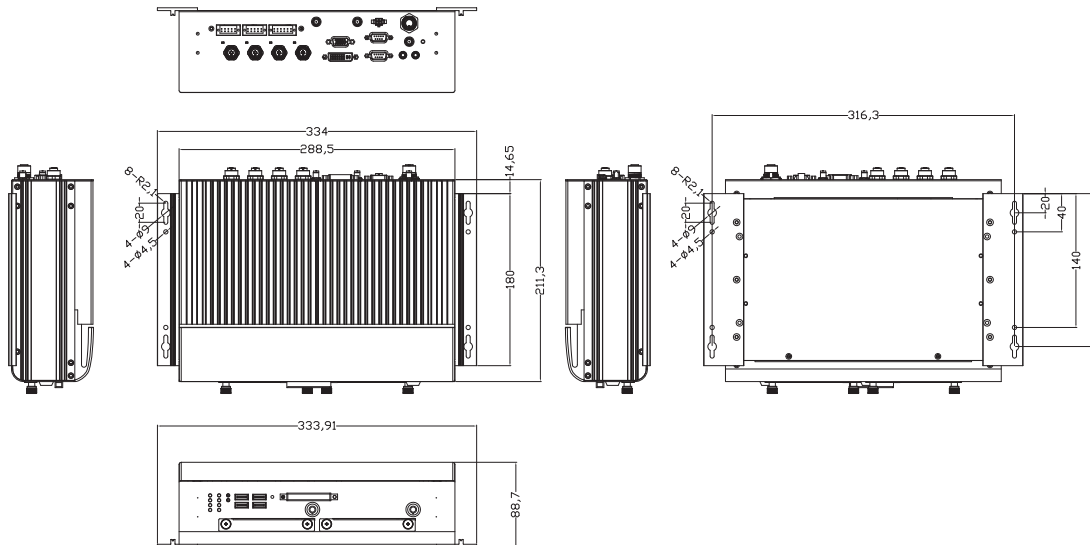

\* All specifications and photos are subject to change without notice. [www.axiomtek.com](http://www.axiomtek.com) © 2019 Axiomtek Co., Ltd. All rights reserved.

# tBOX300-510-FL NEW

Fanless Embedded System with 7th Gen Intel® Core™ i7/i5/i3 & Celeron® Processor for Vehicle, Railway and Marine PC

## Features

- CE (Class A), FCC, EN 50155, EN 50121-3-2, EN 45545-2, and IEC 60945 certified; E-Mark, ISO 7637-2, and DNV 2.4 compliant
- 7th gen Intel® Core™ & Celeron® processors (Kaby Lake)
- Value-added module slot for 9 types of value-added modules (COM/LAN/DIO/PoE/CAN/BNC)
- Supports Marvell Hardware RAID 0/1/10
- External PoE PSU (optional), up to 120W power supply
- Wide operating temperatures from -25°C to +70°C
- Power Input:
  - 24 to 110 VDC for railway version
  - 12/24 VDC for vehicle version
  - 24 VDC for marine version
- Intelligent solution of vehicle power management (ACC ignition)
- 4 swappable 2.5" SATA drives



▲ Front view

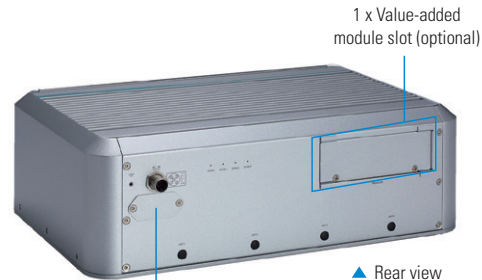

1 x Value-added module slot (optional)

PSU DC-IN connector (optional)

▲ Rear view

## Specifications

Standard Color	Silver				
Construction	Aluminum extrusion and heavy-duty steel, IP30				
CPU	Intel® Core™ i7-7600U 2C @ 2.8 Intel® Core™ i5-7300U 2C @ 2.6 Intel® Core™ i3-7100U 2C @ 2.4 GHz Intel® Celeron® 3965U 2C @ 2.2GHz				
Chipset	SoC integrated				
System Memory	2 x DDR4 SO-DIMM slot, up to 32GB				
BIOS	AMI				
System I/O Outlet	<table border="0"> <tr> <td>Rear</td> <td> <ul style="list-style-type: none"> <li>1 x M12 or terminal block DC-in (optional)</li> <li>1 x PoE power-in (Terminal block, optional)</li> <li>1 x Value-added module slot</li> <li>4 x Antenna opening</li> <li>4 x RAID LED indicator</li> </ul> </td> </tr> <tr> <td>Front</td> <td> <ul style="list-style-type: none"> <li>4 x LED indicator</li> <li>2 x Audio (Mic-in &amp; Line-out)</li> <li>1 x RJ-45 10/100/1000 Mbps Ethernet (Intel® i210-IT)</li> <li>4 x USB 3.0</li> <li>1 x DVI-I</li> <li>1 x DB9 serial console or RS-232/422/485</li> <li>1 x Remote switch</li> <li>1 x Reset bottom</li> <li>4 x HDD/SSD tray</li> </ul> </td> </tr> </table>	Rear	<ul style="list-style-type: none"> <li>1 x M12 or terminal block DC-in (optional)</li> <li>1 x PoE power-in (Terminal block, optional)</li> <li>1 x Value-added module slot</li> <li>4 x Antenna opening</li> <li>4 x RAID LED indicator</li> </ul>	Front	<ul style="list-style-type: none"> <li>4 x LED indicator</li> <li>2 x Audio (Mic-in &amp; Line-out)</li> <li>1 x RJ-45 10/100/1000 Mbps Ethernet (Intel® i210-IT)</li> <li>4 x USB 3.0</li> <li>1 x DVI-I</li> <li>1 x DB9 serial console or RS-232/422/485</li> <li>1 x Remote switch</li> <li>1 x Reset bottom</li> <li>4 x HDD/SSD tray</li> </ul>
Rear	<ul style="list-style-type: none"> <li>1 x M12 or terminal block DC-in (optional)</li> <li>1 x PoE power-in (Terminal block, optional)</li> <li>1 x Value-added module slot</li> <li>4 x Antenna opening</li> <li>4 x RAID LED indicator</li> </ul>				
Front	<ul style="list-style-type: none"> <li>4 x LED indicator</li> <li>2 x Audio (Mic-in &amp; Line-out)</li> <li>1 x RJ-45 10/100/1000 Mbps Ethernet (Intel® i210-IT)</li> <li>4 x USB 3.0</li> <li>1 x DVI-I</li> <li>1 x DB9 serial console or RS-232/422/485</li> <li>1 x Remote switch</li> <li>1 x Reset bottom</li> <li>4 x HDD/SSD tray</li> </ul>				
Watchdog Timer	255 levels, 1 to 255 sec.				
Storage	4 x swappable 2.5" SATA drive (9.5 mm height) 1 x mSATA (use 1 PCI Express Mini Card slot)				
RAID Function	Marvell HW RAID 0/1/10				
Expansion Interface	3 x Full-size PCI Express Mini Card slot 2 x SIM card slot 1 x Value-added module slot				
System Indicator	1 x LED indicator for system power 1 x LED indicator for HDD activities 2 x Programmable				
Power Supply	Railway version DC-input: 24 to 110 VDC (tolerance: 16.8 to 137.5 VDC) Vehicle version DC-input: 12/24 VDC (tolerance: 9 to 36 VDC, w/ ACC ignition) Marine version DC-input: 24 VDC (tolerance: 14 to 32 VDC)				
PoE Power Supply	PoE power output maximum 120W (**/****) 15.4W/8 ports (802.3af), 30W/4 ports (802.3at) * To be used with PoE VAM (VAM701 & 703) ** Different system version has different PSU. *** 24V input Railway ver. is available (Marine by request)				

Operating Temperature	-25°C to +70°C (-13°F to +158°F) with W.T. SSD -25°C to +55°C (-13°F to +131°F) with W.T. HDD
Humidity	10% to 95%, non-condensing
Vibration Endurance (operational)	3 Grms with SSD, 1 Grms with HDD (5 to 500Hz, X/Y/Z direction; random) EN 61373 cat. 1 class B IEC 60068-2-64 MIL-STD-810G, Method 514.6C, Procedure I, Category 4
Shock (non-operating test)	Shock optioning, 50 Grms, Half-sine 11 ms duration (with SSD, according to IEC60068-2-27)
Dimensions	321 mm (12.64") (W) x 210.2 mm (8.28") (D) x 105.33 mm (4.15") (H) 321 mm (12.64") (W) x 210.2 mm (8.28") (D) x 109.33 mm (4.30") (with wall mount)
Weight	4.5 kg (9.92 lb)/6 kg (13.23 lb)
Certifications	CE (Class A), FCC, EN 50155, EN 50121-3-2, EN 45545-2, and IEC 60945 certified; E-Mark, ISO 7637-2, and DNV 2.4 compliant
EOS support	Windows® 10 64-bit, Linux

## Ordering Information







Standard	
tBOX300-510-FL-Celeron/i3/i5/i7-24-110-MRDC	Fanless railway embedded system, Intel® Celeron® 3965U/Core™ i3-7100U/i5-7300U/i7-7600U processor, 4 USB 3.0, DVI-I, RJ-45 LAN, serial console, Mic-in & Line-out, four 2.5" SATA trays, M12 A-code 5P DC-in, and 16.8 to 137.5 VDC
tBOX300-510-FL-Celeron/i3/i5/i7-TVDC <b>No supporting PoE/PoE+</b>	Fanless vehicle embedded system, Intel® Celeron® 3965U/Core™ i3-7100U/i5-7300U/ i7-7600U processor, 4 USB 3.0, DVI-I, RJ-45 LAN, serial console, Mic-in & Line-out, four 2.5" SATA trays, 9 to 36 VDC, TB 3P DC-in, and ACC ignition
tBOX300-510-FL-Celeron/i3/i5/i7-TMDC	Fanless marine embedded system, Intel® Celeron® 3965U/Core™ i3-7100U/i5-7300U/ i7-7600U processor, 4 USB 3.0, DVI-I, RJ-45 LAN, serial console, Mic-in & Line-out, four 2.5" SATA trays, TB 3P DC-in, and 14 to 32 VDC

\*MRDC: M12 DC-IN connector, Railway SKU, DC voltage input

\*TVDC: Terminal Block DC-IN connector, Vehicle SKU, DC voltage input

\*TMDC: Terminal Block DC-IN connector, Marine SKU, DC voltage input

### Value-Added Modules (VAMs)

Item	Specifications	
#1	4 x M12 A-code GbE (PoE optional) (P/N: E277700100) (PoE/PoE+, P/N: E277701100) *PSU is required if select VAM701	 <p style="text-align: center;">VAM700      VAM701 (PoE/PoE+)</p>
#2	4 x RJ-45 A-code GbE (PoE optional) (P/N: E277702100) (PoE/PoE+, P/N: E277703100) *PSU is required if select VAM703	 <p style="text-align: center;">VAM702      VAM703 (PoE/PoE+)</p>
#3	4 x 4-wire isolated RS-232/422/485 (P/N: E277100100)	 <p style="text-align: center;">VAM100</p>
#4	4 x isolated CANbus 2.0A/B (P/N: E277101100)	 <p style="text-align: center;">VAM101</p>
#5	8-in/8-out isolated DIO (P/N: E277200100)	 <p style="text-align: center;">VAM200</p>
#6	1 x PCI Express Mini Card Slot + 1 x SIM Card Slot & 1 x PCI Express Mini Card Slot (USB only) + 1 x SIM Card Slot (P/N: E277600100)	 <p style="text-align: center;">VAM600</p>
#7	4 x Video & 1 x Audio-in +1 x PCI Express Mini Card Slot (USB only) + 1 x SIM Card Slot (P/N: E277400100)	 <p style="text-align: center;">VAM400</p>

\*Specifications and certifications may vary based on different requirements.

### Dimensions

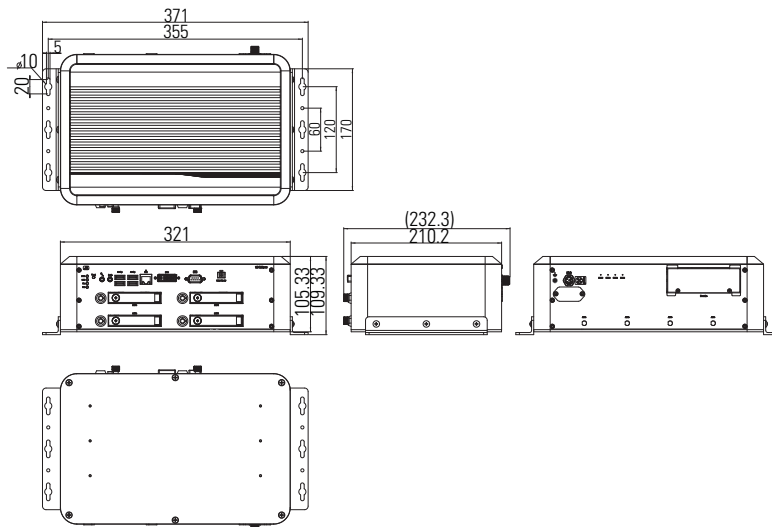

\* All specifications and photos are subject to change without notice. [www.axiomtek.com](http://www.axiomtek.com) © 2019 Axiomtek Co., Ltd. All rights reserved.

### Optional

2.5" SATA HDD/SSD	128GB or above
mSATA	64GB or above
DDR4 SO-DIMM	4GB to 16GB
3G/4G/GPS module	826N3230140E, 82606200410E, 826N5000100E
Wi-Fi/Bluetooth module	826N3230060E, 826N3230100E, 826N3230110E, 826N3230120E
DC in cable	594B8120B30E (M12, with ACC), 594B7100B00E (Wire, with ACC)
LAN cable	594N3202730E (M12-A male 8P to RJ-45)
Remote switch cable	594K3101020E
Value-added module (VAM)	VAM700, VAM701, VAM702, VAM703, VAM100, VAM101, VAM200, VAM600, VAM400
AC to DC adapter	50906D24000E (24V/120W, wire), 50966224010E (24V 90W, M12 Acode 5P)
Power cord	59903000000E (EU), 59906000010E (JP), 59902000000E (US), 59904000000E (UK)
Power supply unit (PSU)	E276120101 PSU120-259-RAILWAY PoE 120W DC/DC external PSU (EN 50155 compliance, 24V-in, 53V-out, available for tBOX500 24V railway version only) E276120102 PSU120-259-RAILWAY-48VDC PoE 120W DC/DC external PSU (EN 50155 compliance, 48V-in, 53V-out, available for tBOX500 48V railway version only) E276120103 PSU120-259-RAILWAY-96/110VDC PoE 120W DC/DC external PSU (EN 50155 compliance, 96/110V-in, 53V-out, available for tBOX500 96/110V railway version only)

\*Specifications and certifications may vary based on different requirements.

### Power Protection

SCP (short circuit protection)  
OVP (over voltage protection)  
UVP (under voltage protection)  
RVP (reverse voltage protection)

### Vehicle Version

ISO 7637-2 pulse 1/2/3/4

Setting for battery protection: Low voltage or very low voltage

Setting for ignition control: Low voltage counter, ACC-ON delay or shut down delay

### Packing List

1 x Quick installation guide  
1 x Driver CD  
4 x Foot pad  
1 x Screw pack  
1 x Wall mount kit  
4 x DRAM thermal pad  
1 x Terminal block DC-in connector (for marine and vehicle version)  
8 x HDD mylar  
4 x SATA drive key

# tBOX500-510-FL

Fanless Embedded System with 7th Gen Intel® Core™ i7/i5/i3 & Celeron® Processor for Railway, Vehicle and Marine PC

## Features

- CE (Class A), FCC, EN 50155, EN 50121, EN 45545-2, and IEC 60945 certified; E-Mark, ISO 7637-2, and DNV2.4 compliance
- 7th gen Intel® Core™ i7/i5/i3 & Celeron® processors (Kaby Lake)
- 2 value-added module slots for 9 types of value-added modules (COM/LAN/DIO/PoE/CAN/BNC)
- External PoE PSU (optional), up to 120W power supply
- Power Input:
  - 24 to 110 VDC for Railway version
  - 12/24 VDC for Vehicle version
  - 24 VDC for Marine version
- Intelligent solution of vehicle power management (ACC ignition)
- 2 swappable 2.5" SATA drives

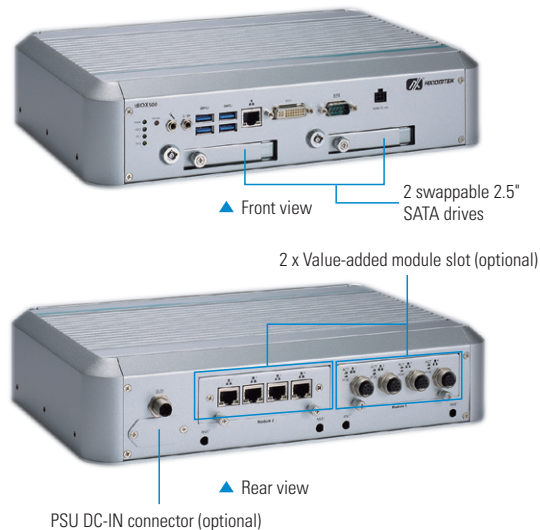

## Specifications

Standard Color	Silver
Construction	Aluminum extrusion and heavy-duty steel, IP30
CPU	Intel® Core™ i7-7600U 2C @ 2.8 GHz Intel® Core™ i5-7300U 2C @ 2.6 GHz Intel® Core™ i3-7100U 2C @ 2.4 GHz Intel® Celeron® 3965U 2C @ 2.2 GHz
Chipset	SoC integrated
System Memory	2 x DDR4-1866/2133 SO-DIMM, up to 32GB
BIOS	AMI
System I/O Outlets	Rear <ul style="list-style-type: none"> <li>1 x M12 or Terminal block DC-in (optional)</li> <li>1 x PoE power-in (Terminal block, optional)</li> <li>2 x Value-added module slot</li> </ul>
	Front <ul style="list-style-type: none"> <li>4 x LED indicator</li> <li>2 x Audio (Mic-in/Line-out)</li> <li>1 x RJ-45 10/100/1000 Mbps Ethernet (Intel® i210-IT)</li> <li>4 x USB 3.0</li> <li>1 x DVI-I</li> <li>1 x DB9 serial console or RS-232/422/485</li> <li>1 x Remote switch</li> <li>1 x Reset bottom</li> <li>2 x HDD/SSD tray</li> </ul>
Watchdog Timer	255 levels, 1 to 255 sec.
Storage	2 x swappable 2.5" SATA drive (9.5 mm height) 1 x mSATA (use 1 PCI Express Mini Card slot)
RAID function	Intel® RAID 0/1
Expansion Interface	3 x Full-size PCI Express Mini Card slot 2 x SIM card slot 2 x Value-added module slot
System Indicator	1 x LED indicator for system power 1 x LED indicator for HDD activities 2 x Programmable
Power Supply	Railway ver. DC-input: 24 to 110 VDC (tolerance: 16.8 to 137.5 VDC) Vehicle ver. DC-input: 12/24 VDC (tolerance: 9 to 36 VDC, with ACC ignition) Marine ver. DC-input: 24 VDC (tolerance: 14 to 32 VDC)
PoE Power Supply	PoE power output maximum 120W (**/****) 15.4W/8 ports (802.3af), 30W/4 ports (802.3at) * To be used with PoE VAM (VAM701 & 703) ** Different system version has different PSU. *** 24V input Railway ver. is available (Marine by request)
Operating Temperature	-40°C to +70°C (-40°F to +158°F) with W.T. SSD -25°C to +55°C (-13°F to +131°F) with HDD -40°C to +60°C (-40°F to +140°F) with external PoE PSU







Humidity	10% to 95%, non-condensing
Vibration Endurance (operational)	3 Grms w/ SSD, 1.5 Grms w/ HDD (5 to 500Hz, X/Y/Z direction; random) EN 61373 cat. 1 class B IEC 60068-2-64 MIL-STD-810G, Method 514.6C, Procedure I, Category 4
Shock (non-operating test)	Shock optioning, 50 Grms, Half-sine 11 ms Duration (w/ SSD, according to IEC60068-2-27)
Dimensions	321 mm (12.64") (W) x 210.2 mm (8.28") (D) x 73.3 mm (2.89") (H)
Weight	3.5 kg (7.72 lb)/4.5 kg (11.02 lb)
Certifications	CE (Class A), FCC, EN 50155, EN 50121, EN 45545-2, and IEC 60945 certified; E-Mark, ISO 7637-2, and DNV2.4 compliance
EOS support	Windows® 10 64-bit, Linux

## Ordering Information

Standard	
tBOX500-510-FL-Celeron/i3/i5/i7-24-110MRDC (P/N: E26N500103) (P/N: E26N500102) (P/N: E26N500101) (P/N: E26N500100)	Fanless railway embedded system, Intel® Celeron® 3965U/ Core™ i3-7100U/i5-7300U/ i7-7600U processor, 4 USB 3.0, DVI-I, RJ-45 LAN, serial console, Mic-in & Line-out, two 2.5" SATA trays, M12 A-code 5P DC-in, and 24 to 110 VDC
tBOX500-510-FL-Celeron/i3/i5/i7-TVDC (P/N: E26N500104) (P/N: E26N500105) (P/N: E26N500106) (P/N: E26N500107)	Fanless vehicle embedded system, Intel® Celeron® 3965U/ Core™ i3-7100U/i5-7300U/ i7-7600U processor, 4 USB 3.0, DVI-I, RJ-45 LAN, serial console, Mic-in & Line-out, two 2.5" SATA trays, 9 to 36 VDC, TB 3P DC-in, and ACC ignition
tBOX500-510-FL-Celeron/i3/i5/i7-TMDC (By request)	Fanless marine embedded system, Intel® Celeron®3965U/ Core™ i3-7100U/i5-7300U/ i7-7600U processor, 4 USB 3.0, DVI-I, RJ-45 LAN, serial console, Mic-in & Line-out, two 2.5" SATA trays, TB 3P DC-in, and 14 to 32VDC

No supporting PoE/PoE+

### Value-Added Modules (VAMs)

Item	Specifications	
#1	4 x M12 A-code GbE (PoE optional) (P/N: E277700100) (PoE/PoE+, P/N: E277701100) *PSU is required if select VAM701	 VAM700      VAM701 (PoE/PoE+)
#2	4 x RJ-45 A-code GbE (PoE optional) (P/N: E277702100) (PoE/PoE+, P/N: E277703100) *PSU is required if select VAM703	 VAM702      VAM703 (PoE/PoE+)
#3	4 x 4-wire isolated RS-232/422/485 (P/N: E277100100)	 VAM100
#4	4 x isolated CANbus 2.0A/B (P/N: E277101100)	 VAM101
#5	8-in/8-out isolated DIO (P/N: E277200100)	 VAM200
#6	1 x PCI Express Mini Card slot + 1 x SIM Card Slot & 1 x PCI Express Mini Card Slot (USB only) + 1 x SIM Card Slot (P/N: E277600100)	 VAM600
#7	4 x Video & 1 x Audio-in +1 x PCI Express Mini Card Slot (USB only) + 1 x SIM Card Slot (P/N: E277400100)	 VAM400

### Dimensions

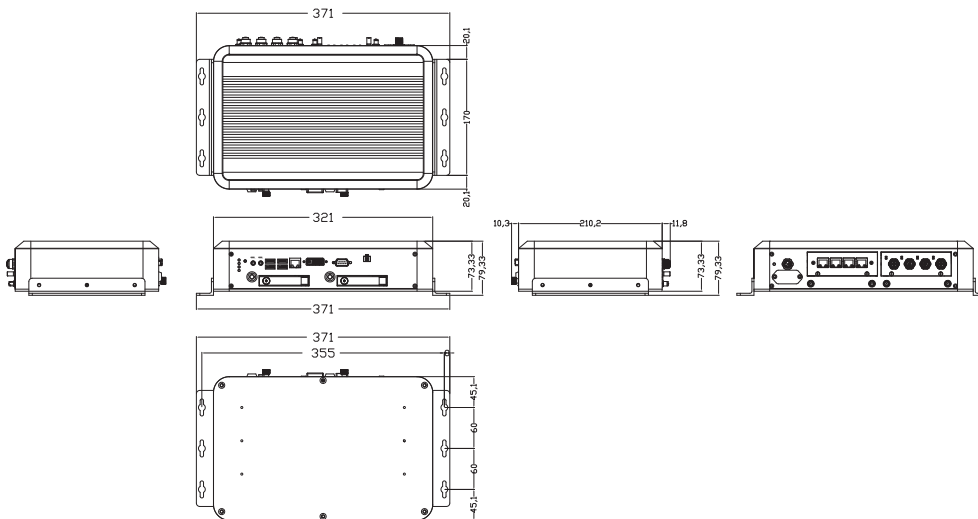

### Optional

2.5" SATA HDD/SSD	128GB or above
mSATA	64GB or above
DDR4 SO-DIMM	4GB to 16GB
3G/4G/GPS module	826N3230140E, 82606200410E, 826N5000100E
Wi-Fi/Bluetooth module	826N3230060E, 826N3230100E, 826N3230110E, 826N3230120E
DC in cable	594B8120B30E (M12, with ACC), 594B7100B00E (Wire, with ACC)
LAN cable	594N3202730E (M12-A male 8P to RJ-45)
Remote switch cable	594K3101020E
Value-added module (VAM)	VAM700, VAM701, VAM702, VAM703, VAM100, VAM101, VAM200, VAM600, VAM400
AC to DC adapter	50906D24000E (24V/120W, wire), 50966224010E (24V 90W, M12 Acode 5P)
Power cord	59903000000E (EU), 59906000010E (JP), 59902000000E (US), 59904000000E (UK)
Power supply unit (PSU)	E276120101 PSU120-259-RAILWAY PoE 120W DC/DC external PSU (EN 50155 compliance, 24V-in, 53V-out, available for tBOX500 24V railway version only) E276120102 PSU120-259-RAILWAY-48VDC PoE 120W DC/DC external PSU (EN 50155 compliance, 48V-in, 53V-out, available for tBOX500 48V railway version only) E276120103 PSU120-259-RAILWAY-96/110VDC PoE 120W DC/DC external PSU (EN 50155 compliance, 96/110V-in, 53V-out, available for tBOX500 96/110V railway version only)

\*Specifications and certifications may vary based on different requirements.

### Power Protection

- SCP (short circuit protection)
- OVP (over voltage protection)
- UVP (under voltage protection)
- RVP (reverse voltage protection)

### Vehicle Version

ISO 7637-2 pulse 1/2/3/4

Setting for battery protection: Low voltage or very low voltage

Setting for ignition control: Low voltage counter, ACC-ON delay or shut down delay

### Packing List

- 1 x Quick installation guide
- 1 x Driver CD
- 4 x Foot pad
- 1 x Screw pack
- 1 x Wall mount kit
- 4 x DRAM thermal pad
- 1 x Terminal block DC-in connector
- 4 x HDD mylar
- 2 x SATA drive key



# UST500-517-FL NEW

Fanless Embedded System with 7th/6th Gen Intel® Core™, Pentium® and Celeron® Processor for Vehicle and Railway PC

## Features

- CE, FCC certified, E-Mark, EN 50155 compliant
- 7th/6th gen Intel® Core™ & Pentium® processors (LGA1151 up to 65W) with Intel® Q170
- Wide operating temperatures from -40°C to +70°C (\*)
- Up to 16 RJ-45 Gigabit PoE ports
- 9 to 36VDC power input, ACC ignition supported
- 2 or 4 2.5" SATA drives and 1 mSATA
- Intelligent solution of vehicle power management (ACC ignition)

\*The CPU loading is applied using Passmark BurnIn Test.

For detail testing criteria, please contact Axiomtek.

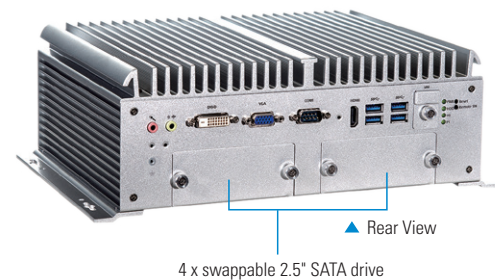
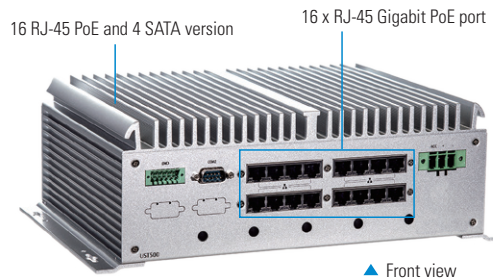

## Specifications

Standard Color	Silver				
Construction	Aluminum extrusion and heavy-duty steel, IP40				
CPU	7th gen Intel® Core™, 35W 6th gen Intel® Core™, 35 to 65W Intel® Pentium®, 35W Intel® Celeron®, 35W				
Chipset	Intel® Q170				
System Memory	2 x DDR4 SO-DIMM slot, up to 64GB				
BIOS	AMI				
System I/O Outlet	<table border="0"> <tr> <td>Rear Side</td> <td>                     1 x 6-in/2-out isolated DIO                      5 x Antenna opening                      1 x DB9 RS-232/422/485                      8/16 x PoE GbE 802.3af/802.3at supported                      - 8 x RJ-45 (with 2 SATA)                      - 16 x RJ-45 (with 4 SATA)                      - 8 x RJ-45, 8 x M12 A coded (with 4 SATA)                      - 8 x M12 A coded (with 4 SATA)                      1 x 3P DC-in                 </td> </tr> <tr> <td>Front Side</td> <td>                     4 x USB 3.0                      1 x VGA                      1 x DVI-D                      1 x HDMI                      1 x Reset button                      1 x Power button                      2 x External accessible SIM card socket                      2 x Audio (Mic-in/Line-out)                      1 x DB9 RS-232/422/485                 </td> </tr> </table>	Rear Side	1 x 6-in/2-out isolated DIO 5 x Antenna opening 1 x DB9 RS-232/422/485 8/16 x PoE GbE 802.3af/802.3at supported - 8 x RJ-45 (with 2 SATA) - 16 x RJ-45 (with 4 SATA) - 8 x RJ-45, 8 x M12 A coded (with 4 SATA) - 8 x M12 A coded (with 4 SATA) 1 x 3P DC-in	Front Side	4 x USB 3.0 1 x VGA 1 x DVI-D 1 x HDMI 1 x Reset button 1 x Power button 2 x External accessible SIM card socket 2 x Audio (Mic-in/Line-out) 1 x DB9 RS-232/422/485
Rear Side	1 x 6-in/2-out isolated DIO 5 x Antenna opening 1 x DB9 RS-232/422/485 8/16 x PoE GbE 802.3af/802.3at supported - 8 x RJ-45 (with 2 SATA) - 16 x RJ-45 (with 4 SATA) - 8 x RJ-45, 8 x M12 A coded (with 4 SATA) - 8 x M12 A coded (with 4 SATA) 1 x 3P DC-in				
Front Side	4 x USB 3.0 1 x VGA 1 x DVI-D 1 x HDMI 1 x Reset button 1 x Power button 2 x External accessible SIM card socket 2 x Audio (Mic-in/Line-out) 1 x DB9 RS-232/422/485				
Watchdog Timer	255 levels, 1 to 255 sec.				

Storage	2 x Built-in 2.5" SATA drive (15 mm height) 4 x Swappable 2.5" SATA drive (15 mm height) 1 x mSATA (use 1 PCI Express Mini Card slot)
RAID Function	Intel® RAID 0/1/5/10
Expansion Interface	2 x Full-size PCI Express Mini Card slot 2 x Half-size PCI Express Mini Card slot 2 x External accessible SIM card slot
LED indicator	1 x System power 1 x HDD active 2 x Programmable
PoE Power	802.3 af/802.3at supported, 16-port PoE power output 120W (default), maximum 200W (BIOS setting)
Power Supply	DC-input: 9 to 36 VDC, ACC ignition, typical 24 VDC
Power Consumption	24VDC @9.09A
Operating Temperature	-40°C to +70°C (-40°F to +158°F) with W.T. SSD
Humidity	10% to 95%, non-condensing
Vibration Endurance (operational)	3 Grms with SSD (5 to 500 Hz, X/Y/Z direction; random)
Dimensions	280 mm (11.02") (W) x 210.5 mm (8.27") (D) x 70 mm (2.76") (H) with 2 SATA (internal accessible), w/o wall-mount 280 mm (11.02") (W) x 210.5 mm (8.27") (D) x 99.2 mm (3.91") (H) with 4 SATA with wall-mount
Weight (net/gross)	4.92 kg (10.85 lb)/5.75 kg (12.68 lb)
Certifications	CE, FCC certified, E-Mark, EN 50155 compliant
EOS support	Windows® 7, Windows® 8, Windows® 10, Linux *Windows® 7/8 only available for Skylake processor (6th gen)

## Ordering Information

### Standard

UST500-517-FL-16RJ-4SATA-TDC (P/N: E274500100)	Fanless embedded system with 7/6th gen Intel® desktop processor (LGA1151), Intel® Q170, VGA, DVI-D, HDMI, 6-in/2-out DIO, 2 COM, 4 USB 3.0, 16 RJ-45 Gigabit PoE, 4 SATA drive and ACC ignition
UST500-517-FL-8RJ8M12-4SATA-TDC (P/N: E274500101)	Fanless embedded system with 7/6th gen Intel® desktop processor (LGA1151), Intel® Q170, VGA, DVI-D, HDMI, 6-in/2-out DIO, 2 COM, 4 USB 3.0, 8 RJ-45 Gigabit PoE, 8 M12 A-coded Gigabit PoE, 4 SATA drive and ACC ignition
UST500-517-FL-8M12-4SATA-TDC (P/N: E274500102)	Fanless embedded system with 7/6th gen Intel® desktop processor (LGA1151), Intel® Q170, VGA, DVI-D, HDMI, 6-in/2-out DIO, 2 COM, 4 USB 3.0, 8 M12 A-coded Gigabit PoE, 4 SATA drive and ACC ignition
UST500-517-FL-8RJ-2SATA-TDC 2018 Q4 available	Fanless embedded system with 7/6th gen Intel® desktop processor (LGA1151), Intel® Q170, VGA, DVI-D, HDMI, 6-in/2-out DIO, 2 COM, 4 USB 3.0, 8 RJ-45 Gigabit PoE, 2 SATA drive and ACC ignition

\*TDC: Terminal Block DC-IN connector, Vehicle&Railway SKU, DC voltage input

### Optional

2.5" SATA HDD/SSD	128GB or above
mSATA	128GB
DDR4 SO-DIMM	4GB to 32GB
826N3230140E	3G/GPS module
826K6600090E	Wi-Fi/Bluetooth module
594N3202730E	LAN cable (M12-A male 8P to RJ-45)

\*Specifications and certifications may vary based on different requirements.

## Power Protection

SCP (short circuit protection)  
 OVP (over voltage protection)  
 UVP (under voltage protection)  
 RVP (reverse voltage protection)

### Vehicle Version

ISO 7637-2 pulse 1/2/3/4  
 Setting for battery protection: Low voltage or very low voltage  
 Setting for ignition control: Low voltage counter, ACC-ON delay or shut down delay

## Packing List

- 1 x UST500-517-FL system unit
- 1 x Quick installation guide
- 1 x DVD (for drivers and manual)
- 1 x CPU grease
- 1 x Audio cable fixed
- 1 x HDMI cable fixed
- 3 x Cable fixed screws
- 3 x Cable tie
- 16 x HDD screws
- 1 x Terminal block
- 1 x Programming DI/DO connector
- 1 x Wall mount kit
- 4 x Wall mount kit screw (round head)
- 8 x Mini Card slot screw x 8

## Dimensions

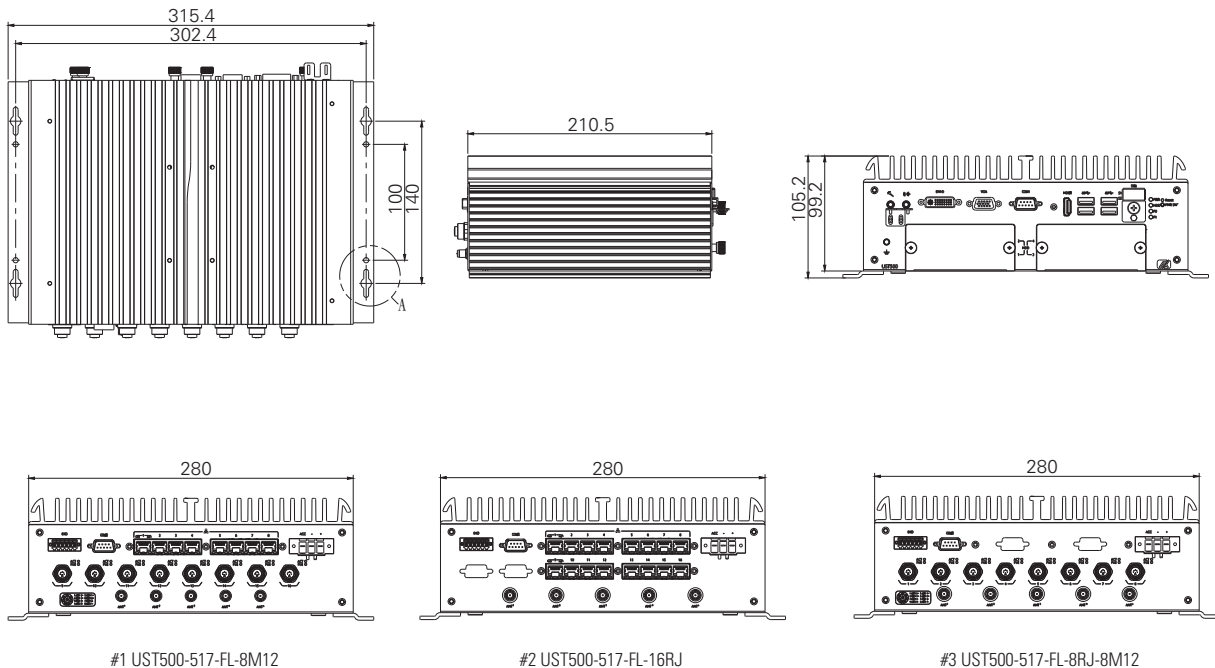

# 3

## DIN-rail Embedded Systems

Axiomtek's rBOX series, ICO series, IFB series and IRU series provide solutions as industrial IoT gateways, specifically designed for intelligent computing and communication applications like power plant automation, intelligent transportation systems, unmanned control room and more. When it comes to Industrial IoT or Industry 4.0 solution, one of the important factors is the gateway solution. The Industrial IoT gateway collects data from sensor and sends the data to cloud. Axiomtek provides a variety of gateway products which have passed heavy industrial EMI/EMS (Electro-Magnetic Susceptibility/Electro-Magnetic Interference) tests, and are also in compliance with multiple safety standards including ATEX and C1D2 certifications (anti-explosion).

Selection Guide 155

### x86-based Series

IC0120-83D Robust DIN-rail Fanless Embedded System with Intel® Celeron® Processor N3350, COM or CAN, 2 LAN, 2 USB and DIO 159

IC0320-83C Robust DIN-rail Fanless Embedded System with Intel® Celeron® Processor N3350/Pentium® Processor N4200, COM or CAN, PoE LAN and DIO 161

IC0100-839 Robust DIN-rail Fanless Embedded System with Intel® Celeron® Processor N3350, 2 COM, LAN, 2 USB and DIO 163

 IC0300-83B Robust DIN-rail Fanless Embedded System with Intel® Celeron® Processor N3350/Pentium® Processor N4200, Isolated COM, LAN and DIO 165

IC0300 Robust DIN-rail Fanless Embedded System with Intel® Atom® Processor E3815/E3827, 4 COM, 2 LANs, DIO and RTC 167

IC0310 Robust DIN-rail Fanless Embedded System with Intel® Celeron® Processor N3060/N3160, 2 COM, 4 USB, 2 GbE LANs (1 PoE PD), DIO and RTC 169

 IC0500-518 Fanless Embedded System with 7th Gen Intel® Core™ i7/i5/i3 & Celeron® Processor and Dual Modular I/O Expansion Design 171

rBOX510-6COM (ATEX/C1D2) ATEX & CID2 Anti-Explosion Certified Robust DIN-rail Fanless Embedded System with Intel® Atom® Processor E3827 173

### ARM-based Series

IRU152 Robust RISC-based DIN-rail Fanless Embedded System with i.MX 6UL Processor, COM, LAN, DIO (2-in/2-out), 4 AI Channels (16-bit, 250 kS/s) and 2 PCIe Mini Card Slots 175

IRU151	Robust RISC-based DIN-rail Fanless Embedded System with i.MX 6UL Processor, COM, LAN, DIO (2-in/2-out), 4 AI Channels (16-bit, 100 S/s) and 2 PCIe Mini Card Slots	177
IRU131	Robust RISC-based DIN-rail Fanless Embedded System with i.MX 6UL Processor, COM, LAN, DIO (2-in/2-out) and 2 PCIe Mini Card Slots	179
IFB122	Robust RISC-based DIN-rail Fanless Embedded System with i.MX 6UL Processor, 2 COM, 2 LANs and DIO (2-in/1-out)	181
IFB112	Robust RISC-based DIN-rail Fanless Embedded System with i.MX 6UL Processor, COM, CANbus, 2 LANs and DIO (2-in/1-out)	183
IFB125	Robust RISC-based DIN-rail Fanless Embedded System with i.MX 6UL Processor, COM, SPI, I2C, 2 LANs and DIO (2-in/1-out)	185

# Systems and Platforms

# x86-based DIN-rail Embedded Systems

## Selection Guide



Features/Models	ICO120-83D	ICO320-83C	ICO100-839	ICO300-83B
<b>CPU Level</b>	Intel® Celeron® N3350 1.1 GHz	Intel® Celeron® N3350 1.1 GHz	Intel® Celeron® N3350 1.1 GHz	Intel® Celeron® N3350 1.1 GHz Intel® Celeron® N4200 1.1 GHz
<b>System Memory</b>	1 x DDR3L-1866 SO-DIMM, up to 8GB	1 x DDR3L SO-DIMM slot, up to 8GB	1 x DDR3L-1866 SODIMM, up to 8GB	1 x DDR3L-1866 SODIMM, up to 8GB
<b>Chipset</b>	SoC integrated	SoC integrated	SoC integrated	SoC integrated
<b>Serial</b>	1 x RS-232/422/485	1 x RS-232/422/485	2 x RS-232/422/485	4 x isolated RS-232/422/485 (Celeron® N3350/N4200) 2 x isolated RS-232/422/485 (Celeron® N3350) 4 x RS-232/422/485 (Celeron® N3350)
<b>CANbus</b>	CANbus 2.0A/B	CANbus 2.0A/B	N/A	N/A
<b>Display</b>	1 x VGA	1 x VGA	1 x VGA	1 x VGA or HDMI (optional)
<b>Ethernet</b>	2 x 10/100/1000 Mbps Ethernet	4 x 10/100/1000 Mbps Ethernet	1 x 10/100/1000 Mbps Ethernet	2 x 10/100/1000 Mbps Ethernet
<b>PoE</b>	N/A	4 x PoE	N/A	N/A
<b>DIO</b>	1 x DI/DO (8-bit programmable)	1 x DIO (8-bit programming)	1 x DIO (8-bit programming)	1 x DIO (8-bit Programming) (optional)
<b>USB</b>	2 x USB 3.0, 2 x USB 3.0	2 x USB 3.0	2 x USB 2.0	4 x USB 3.0
<b>Storage</b>	1 x half-size mSATA or 1 x eMMC flash on board (optional)	1 x mSATA 1 x 2.5" SATA drive	1 x mSATA or 1 x eMMC flash on board (optional)	1 x mSATA 1 x 2.5" SATA drive
<b>Watchdog Timer</b>	255 levels, 1 to 255 sec.	255 levels, 1 to 255 sec.	255 levels, 1 to 255 sec.	255 levels, 1 to 255 sec.
<b>Power Input</b>	12 to 24 VDC (terminal block)	12 to 24 VDC (terminal block)	12 to 24 VDC (terminal block)	12 to 24 VDC (terminal block)
<b>Operating Temperature</b>	-20°C to +70°C (-4°F to +158°F) Optional for -40°C to +70°C (-40°F to +158°F)	-20°C to +70°C (-4°F to +158°F) Optional -40°C to +70°C (-40°F to +158°F)	-20°C to +70°C (-4°F to +158°F) Optional -40°C to +70°C (-40°F to +158°F)	-20°C to +70°C (-4°F to +158°F) Optional -40°C to +70°C (-40°F to +158°F)
<b>Dimensions (W x D x H)</b>	31 x 100 x 125 mm (1.22" x 3.93" x 4.92")	79 x 110 x 155 mm (3.11" x 4.33" x 6.1")	31 x 100 x 125 mm (1.22" x 3.93" x 4.92")	48 x 110 x 155 mm (1.88" x 4.33" x 6.1")
<b>Weight (net/gross)</b>	0.3 kg (0.67 lb)/0.46 kg (1 lb)	PoE Version: 1.2 kg (2.2 lb)/1.70 kg (3.3 lb) LAN Version: 1.0 kg (2.2 lb)/1.50 kg (3.3 lb)	0.3 kg (0.67 lb)/0.46 kg (1 lb)	1.0 kg (2.2 lb)/1.50 kg (3.3 lb)
<b>Certifications</b>	CE, FCC	CE, FCC	CE, FCC	CE, FCC
<b>Compliance</b>	IEC 60068	IEC 60068	IEC 60068	IEC 60068
<b>EOS Support</b>	Windows® 10 IoT, Linux support package	Windows® 10 IoT, Linux support package	Windows® 10 IoT, Linux support package	Windows® 10, Linux support package
<b>AXView Support</b>	Yes	N/A	Yes	N/A



# x86-based DIN-rail Embedded Systems

## Selection Guide



Features/Models	ICO300	ICO310	ICO500-518	rBOX510-6COM(ATEX/CID2)
<b>CPU Level</b>	Intel® Atom® E3815 1.46 GHz Intel® Atom® E3827 1.75 GHz	Intel® Celeron® N3060 1.6 GHz Intel® Celeron® N3160 1.6 GHz	Intel® Core™ i7-7600U 2.8 to 3.9 GHz Intel® Core™ i5-7300U 2.6 to 3.5 GHz Intel® Core™ i3-7100U 2.4 GHz Intel® Celeron® 3965U 2.2 GHz	Intel® Atom® E3827 1.75 GHz
<b>System Memory</b>	1 x DDR3L-1067/1333 SO-DIMM, up to 4GB (E3815) or up to 8GB (E3827)	1 x DDR3L-1600 SODIMM, up to 8GB	DDR4-1866/2133 SO-DIMM, up to 16GB	4 GB DDR3L onboard
<b>Chipset</b>	SoC integrated	SoC integrated	N/A	SoC integrated
<b>Serial</b>	4 x RS-232/422/485	2 x RS-232/422/485	1 x RS-232/422/485 (Expanded by 2 PIM, up to 17 port)	2 x RS-232/422/485 4 x isolated RS-232/422/485
<b>CANbus</b>	N/A	N/A	Expanded by 2 PIM, up to 16 port	N/A
<b>Display</b>	1 x VGA	1 x VGA	1 x HDMI 1 x VGA	1 x VGA
<b>Ethernet</b>	2 x 10/100/1000 Mbps Ethernet	1 x 10/100/1000 Mbps Ethernet	2 x 10/100/1000 Mbps Ethernet (Expanded by 2 PIM, up to 10 port)	2 x 10/100/1000 Mbps Ethernet
<b>PoE</b>	N/A	1 x PoE PD (supports 10/100/1000 Ethernet)	Expanded by PIM	N/A
<b>DIO</b>	1 x DIO (8-bit Programming)	1 x DIO (8-bit programming)	1 x isolated DIO (4-in/4-out) (expanded by 2 PIM up to 16DI/16DO)	1 x isolated DIO (8-in/8-out)
<b>USB</b>	2 x USB 2.0	2 x USB 3.0 2 x USB 2.0	4 x USB 3.0	1 x USB 3.0 1 x USB 2.0
<b>Storage</b>	1 x CompactFlash™ (or mSATA) 1 x 2.5" SATA SSD/HDD drive bay	1 x mSATA 1 x 2.5" SATA SSD/HDD drive bay	1 x CFast 1 x 2.5" 9.5mm SATA drive	1 x CompactFlash™ 1 x 2.5" SATA SSD/HDD drive bay or 1 x mSATA slot
<b>Watchdog Timer</b>	255 levels, 1 to 255 sec.	255 levels, 1 to 255 sec.	255 levels, 1 to 255 sec.	255 levels, 1 to 255 sec.
<b>Power Input</b>	12 to 24 VDC (terminal block)	12 to 24 VDC (terminal block)	12 to 48 VDC (terminal block)	12 to 48 VDC (terminal block)
<b>Operating Temperature</b>	-20°C to +70°C (-4°F to +158°F)	-20°C to +60°C (-4°F to +140°F)	-20°C to +70°C (-4°F to +158°F) (with W.T. SSD)	-40°C to +70°C (-40°F to +158°F)
<b>Dimensions (W x D x H)</b>	48 x 110 x 155 mm (1.88" x 4.33" x 6.1")	48 x 110 x 155 mm (1.88" x 4.33" x 6.1")	145 x 125 x 155 mm (5.70" x 4.92" x 6.10")	85.6 x 110 x 155 mm (3.37" x 4.33" x 6.1")
<b>Weight (net/gross)</b>	1.0 kg (2.2 lb)/1.50 kg (3.3 lb)	1.0 kg (2.2 lb)/1.50 kg (3.3 lb)	TBC	1.5 kg (3.3 lb)/1.88 kg (4.14 lb)
<b>Certifications</b>	CE, FCC, UL	CE, FCC	CE (Class A), FCC	Heavy industrial CE, FCC Part 18, UL/Cul60950-1, ATEX & C1D2 Anti-Explosive
<b>Compliance</b>	IEC 60068	IEC 60068	N/A	IEC 60068
<b>EOS Support</b>	Windows® 7 Embedded, Windows® 8 Embedded, Windows® 10 IoT Core Pro, Linux support package	Windows® 7 Embedded, Windows® 8 Embedded, Windows® 8, Windows® 10, Linux support package	Windows 10, Linux	Windows® 7 Embedded, Linux support package, Windows® 8 Embedded
<b>AXView Support</b>	N/A	Yes	Yes	Yes



# ARM-based DIN-rail Embedded Systems

## Selection Guide



Features\Wodels	IRU152	IRU151	IRU131
<b>CPU Level</b>	NXP i.MX 6UltraLite, ARM® Cortex®-A7, 528 MHz	NXP i.MX 6UltraLite, ARM® Cortex®-A7, 528 MHz	NXP i.MX 6UltraLite, ARM® Cortex®-A7, 528 MHz
<b>System Memory</b>	1 x DDR3 512MB onboard	1 x DDR3 512MB onboard	1 x DDR3 512MB onboard
<b>Wireless</b>	2 x PCI Express Mini Card slot (USB signal only) 1 x SIM card socket	2 x PCI Express Mini Card slot (USB signal only) 1 x SIM card socket	2 x PCI Express Mini Card slot (USB signal only) 1 x SIM card socket
<b>Serial</b>	1 x RS-232/422/485 (console/COM switch)	1 x RS-232/422/485 (console/COM switch)	1 x RS-232/422/485 (console/COM switch)
<b>DIO</b>	1 x DIO (2-in/2-out) (isolation 2 KV)	1 x DIO (2-in/2-out) (isolation 2 KV)	1 x DIO (2-in/2-out) (isolation 2 KV)
<b>Analog Input</b>	4 AI channels (16-bit, 250 kS/s)	4 AI channels (16-bit, 100 S/s)	N/A
<b>Ethernet</b>	2 x 10/100 Mbps (isolation 1.5 KV )	2 x 10/100 Mbps (isolation 1.5 KV )	2 x 10/100 Mbps (isolation 1.5 KV )
<b>USB</b>	1 x USB	1 x USB	1 x USB
<b>Device ID</b>	ID setting 0 to 255	ID setting 0 to 255	ID setting 0 to 255
<b>Storage</b>	1 x eMMC 8GB flash onboard	1 x eMMC 8GB flash onboard	1 x eMMC 8GB flash onboard
<b>Watchdog Timer</b>	0.5 to 128 sec. (time resolution of 0.5 sec.)	0.5 to 128 sec. (time resolution of 0.5 sec.)	0.5 to 128 sec. (time resolution of 0.5 sec.)
<b>Power Supply</b>	9 to 48 VDC	9 to 48 VDC	9 to 48 VDC
<b>Operating Temperature</b>	-40°C to +70°C (-40°F to +158°F)	-40°C to +70°C (-40°F to +158°F)	-40°C to +70°C (-40°F to +158°F)
<b>DIN-rail</b>	Yes	Yes	Yes
<b>Dimensions (W x D x H)</b>	55 x 82 x 108 mm (2.16" x 3.23" x 4.25")	55 x 82 x 108 mm (2.16" x 3.23" x 4.25")	55 x 82 x 108 mm (2.16" x 3.23" x 4.25")
<b>Weight (net/gross)</b>	0.32 kg (0.71 lb)/0.53 kg (1.17 lb)	0.32 kg (0.71 lb)/0.53 kg (1.17 lb)	0.3 kg (0.66 lb)/0.50 kg (1.10 lb)
<b>Certifications</b>	Heavy industrial CE, FCC part 15	Heavy industrial CE, FCC part 15	Heavy industrial CE, FCC part 15
<b>EOS Support</b>	Yocto (Linux Kernel : 3.14.52)	Yocto (Linux Kernel : 3.14.52)	Yocto (Linux Kernel : 3.14.52)

# ARM-based DIN-rail Embedded Systems

## Selection Guide



Features/Models	IFB122	IFB112	IFB125
<b>CPU Level</b>	NXP i.MX 6UltraLite, ARM® Cortex®-A7, 528 MHz	NXP i.MX 6UltraLite, ARM® Cortex®-A7, 528 MHz	NXP i.MX 6UltraLite, ARM® Cortex®-A7, 528 MHz
<b>System Memory</b>	1 x DDR3 256MB onboard	1 x DDR3 256MB onboard	1 x DDR3 256MB onboard
<b>Serial</b>	2 x RS-232/422/485 (selected by software)	1 x RS-232/422/485 (selected by software)	1 x RS-232/422/485
<b>CANbus</b>	N/A	1 x CANbus	N/A
<b>Console Port</b>	Yes	Yes	Yes
<b>Ethernet</b>	2 x 10/100 Mbps (isolation 1.5 KV )	2 x 10/100 Mbps (isolation 1.5 KV )	2 x 10/100 Mbps (isolation 1.5 KV )
<b>Wireless</b>	1 x PCI Express Mini Card slot (USB signal only) 1 x SIM card socket	1 x PCI Express Mini Card slot (USB signal only) 1 x SIM card socket	1 x PCI Express Mini Card slot (USB signal only) 1 x SIM card socket
<b>DIO</b>	1 x DIO (2-in/1-out)	1 x DIO (2-in/1-out)	1 x DIO (2-in/1-out)
<b>USB</b>	1 x USB 2.0	1 x USB 2.0	1 x USB 2.0
<b>Expansion Interface</b>	N/A	N/A	1 x I <sup>2</sup> C (with 3.3V @ 0.5A powered) 1 x SPI (with 3.3V @ 0.5A powered) (DB9 connector)
<b>Storage</b>	1 x eMMC 4GB onboard	1 x eMMC 4GB flash onboard	1 x eMMC 8GB flash onboard
<b>Watchdog Timer</b>	0.5 to 128 sec. (time resolution of 0.5 sec.)	0.5 to 128 sec. (time resolution of 0.5 sec.)	0.5 to 128 sec. (time resolution of 0.5 sec.)
<b>Power Input</b>	9 to 48 VDC	9 to 48 VDC	9 to 48 VDC
<b>Operating Temperature</b>	-40°C to +70°C (-40°F to +158°F)	-40°C to +70°C (-40°F to +158°F)	-40°C to +70°C (-40°F to +158°F)
<b>Dimensions (W x D x H)</b>	31 x 100 x 125 mm (1.22" x 3.94" x 4.92")	31 x 100 x 125 mm (1.22" x 3.94" x 4.92")	31 x 100 x 125 mm (1.22" x 3.94" x 4.92")
<b>Weight (net/gross)</b>	0.3 kg (0.66 lb)/0.44 kg (0.97 lb)	0.3 kg (0.66 lb)/0.44 kg (0.97 lb)	0.3 kg (0.66 lb)/0.44 kg (0.97 lb)
<b>Certifications</b>	Heavy industrial CE, FCC part 15	Heavy industrial CE, FCC part 15	Heavy industrial CE, FCC part 15
<b>OS Support</b>	Yocto (Linux Kernel : 3.14.52)	Yocto (Linux Kernel : 3.14.52)	Yocto (Linux Kernel : 3.14.52)

DIN-rail Embedded Systems

- 1
- 2
- 3
- 4
- 5
- 6
- 7
- 8

# IC0120-83D

Robust DIN-rail Fanless Embedded System with Intel® Celeron® Processor N3350, COM or CAN, 2 LAN, 2 USB and DIO

## Features

- Extreme cost-effective with fanless and cableless design
- Intel® Celeron® processor N3350
- 1 COM or CAN, 2 USB, 2 GbE LAN
- 8-bit programmable DIO for IoT gateway applications
- Wide operating temperature range from -40°C to +70°C
- 12 to 24 VDC wide range power input
- OVP, UVP, OCP, RPP power protection design
- AXView 2.0 intelligent remote monitoring software for IIoT



## Specifications

Standard Color	Sliver																		
Construction	Extruded aluminum and heavy-duty steel, IP40																		
CPU	Intel® Celeron® processor N3350 (1.1 GHz, Dual Core)																		
System Board	SBC8783D																		
System Memory	1 x DDR3L-1866 SO-DIMM, up to 8GB																		
BIOS	AMI UEFI BIOS																		
System I/O Outlet	<table border="0"> <tr> <td>Serial</td> <td>1 x RS-232/422/485 Interface select by BIOS Supports Auto Flow Control in RS-485 mode</td> </tr> <tr> <td>RTC</td> <td>Battery onboard</td> </tr> <tr> <td>USB</td> <td>2 x USB 3.0, 2 x USB 2.0</td> </tr> <tr> <td>Storage</td> <td>Half-size mSATA shared with half-size mPCIe slot (option eMMC flash onboard)</td> </tr> <tr> <td>LAN</td> <td>2 x 10/100/1000 Mbps Ethernet (Intel® i211-AT for IC0120) (Intel® i210-IT for IC0120-WT) Magnetic isolation protection 1.5KV</td> </tr> <tr> <td>Display</td> <td>1 x VGA (DB15 connector)</td> </tr> <tr> <td>DIO</td> <td>1 x DI/DO (8-bit programmable, DB9 female connector) Voltage is 5V TTL-level Programming: I/O sink current is 10mA (max.) Input/output can be programming</td> </tr> <tr> <td>CAN</td> <td>1 x CAN 2.0 A/B (DB9 connector) (IC0120-CAN)</td> </tr> <tr> <td>Power Input</td> <td>1 x DC power input with terminal block</td> </tr> </table>	Serial	1 x RS-232/422/485 Interface select by BIOS Supports Auto Flow Control in RS-485 mode	RTC	Battery onboard	USB	2 x USB 3.0, 2 x USB 2.0	Storage	Half-size mSATA shared with half-size mPCIe slot (option eMMC flash onboard)	LAN	2 x 10/100/1000 Mbps Ethernet (Intel® i211-AT for IC0120) (Intel® i210-IT for IC0120-WT) Magnetic isolation protection 1.5KV	Display	1 x VGA (DB15 connector)	DIO	1 x DI/DO (8-bit programmable, DB9 female connector) Voltage is 5V TTL-level Programming: I/O sink current is 10mA (max.) Input/output can be programming	CAN	1 x CAN 2.0 A/B (DB9 connector) (IC0120-CAN)	Power Input	1 x DC power input with terminal block
Serial	1 x RS-232/422/485 Interface select by BIOS Supports Auto Flow Control in RS-485 mode																		
RTC	Battery onboard																		
USB	2 x USB 3.0, 2 x USB 2.0																		
Storage	Half-size mSATA shared with half-size mPCIe slot (option eMMC flash onboard)																		
LAN	2 x 10/100/1000 Mbps Ethernet (Intel® i211-AT for IC0120) (Intel® i210-IT for IC0120-WT) Magnetic isolation protection 1.5KV																		
Display	1 x VGA (DB15 connector)																		
DIO	1 x DI/DO (8-bit programmable, DB9 female connector) Voltage is 5V TTL-level Programming: I/O sink current is 10mA (max.) Input/output can be programming																		
CAN	1 x CAN 2.0 A/B (DB9 connector) (IC0120-CAN)																		
Power Input	1 x DC power input with terminal block																		

Extension Interface	1 x Full-size PCI Express Mini Card slot with SIM slot (for wireless module) 1 x Half-size PCI Express Mini Card slot with mSATA (for wireless module or half size mSATA)
Watchdog Timer	255 levels, 1 to 255 sec.
System Indicator	Power, active
Power Supply	Power input range: 12 to 24 VDC, 1.39 to 0.72A (16.68 to 17.28W) Protection: OVP (±20%), reverse protection
Operating Temperature	-20°C to +70°C (-4°F to +158°F) -40°C to +70°C (-40°F to +158°F) (IC0120-WT)
Humidity	10% to 95%
Vibration Endurance	2 Gms (5 to 500Hz, amplitude 0.35 mm; operation/storage/transport)
Weight (net/gross)	0.3 kg (0.67 lb)/0.46 kg (1 lb)
Certifications	CE, FCC Class A
Dimensions	31 mm (1.22") (W) x 100 mm (3.93") (D) x 125 mm (4.92") (H)
EOS Support	Windows® 10 IoT, AXView 2.0 Linux support package (by request)

## Ordering Information

Standard	
ICO120-83D-N3350-COM (P/N: E22C120101)	Robust DIN-rail fanless embedded system with Intel® Celeron® processor N3350, COM, 2 LAN, 2 USB and DIO (-20°C to +70°C)
ICO120-83D-N3350-CAN (P/N: E22C120100)	Robust DIN-rail fanless embedded system with Intel® Celeron® processor N3350, CAN, 2 LAN, 2 USB and DIO (-20°C to +70°C)
ICO120-83D-N3350-COM-WT (P/N: E22C120102)	Robust DIN-rail fanless embedded system with Intel® Celeron® processor N3350, COM, 2 LAN, 2 USB and DIO (-40°C to +70°C)
ICO120-83D-N3350-CAN-WT (P/N: E22C120103)	Robust DIN-rail fanless embedded system with Intel® Celeron® processor N3350, CAN, 2 LAN, 2 USB and DIO (-40°C to +70°C)

Optional	
mSATA	
8812C1003A0E	ICO100/ICO120 wall mount bracket kit SFP
8816N3234A0E	3G/GPS UC20G kit for tBOX (3G ANT) (E)
8816N3235A0E	3G/GPS UC20G kit for tBOX (3G/GPS ANT) (E)
8812C3003A0E	SparkLAN WPEA-152GN Wi-Fi kit ICO SFP (E)
8812C3004A0E	SparkLAN WPEA-251N Wi-Fi kit ICO SFP (E)
82606200390E	LTE module SIERRA MC7304KIT for EU SFP
822C3001060E	LTE SIMCOM SIM7100C (TW) for ICO300 SFP

\* Specifications and certifications may vary based on different requirements.

## Dimensions

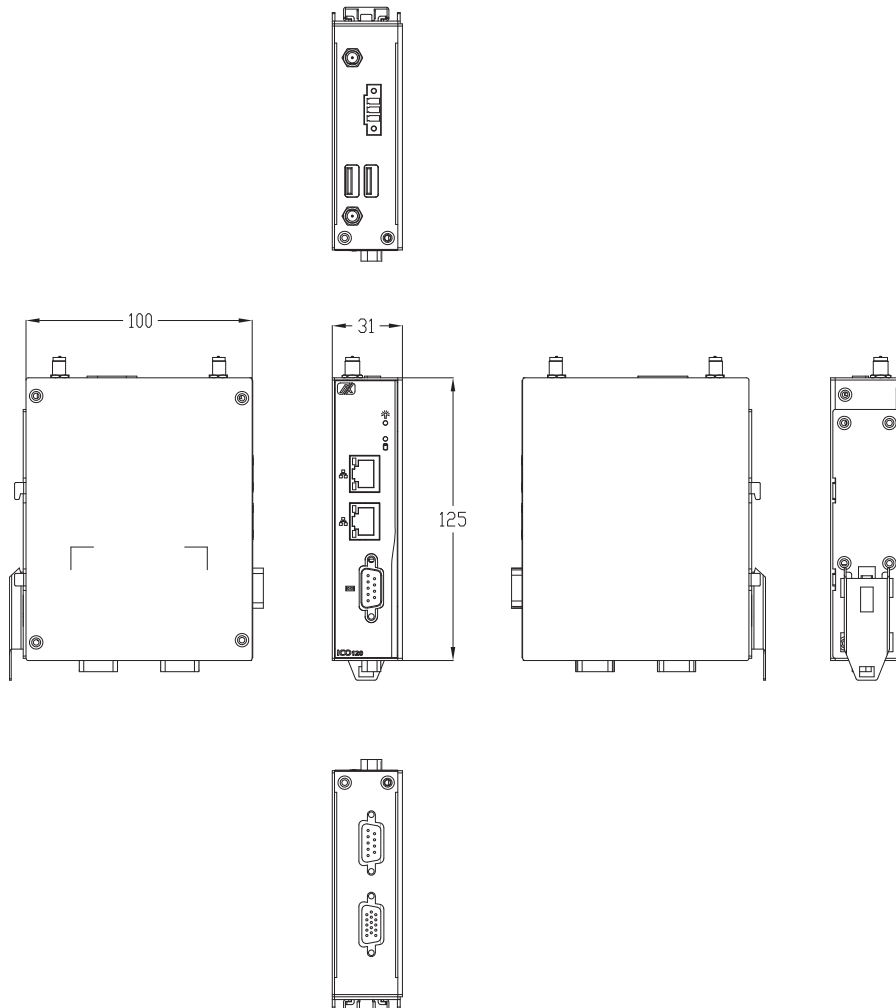



# IC0320-83C

Robust DIN-rail Fanless Embedded System with Intel® Celeron® Processor N3350, COM or CAN, PoE LAN and DIO

## Features

- Cost-effective with fanless and cableless design
- Intel® Celeron® processor N3350
- 4 RJ-45 Gigabit PoE ports
- 8-bit programmable DIO for IoT gateway applications
- Wide operating temperature range from -40°C to +70°C
- 12 to 24 VDC wide range power input
- OVP, UVP, OCP, RVP power protection
- AXView 2.0 intelligent remote monitoring software for IIoT

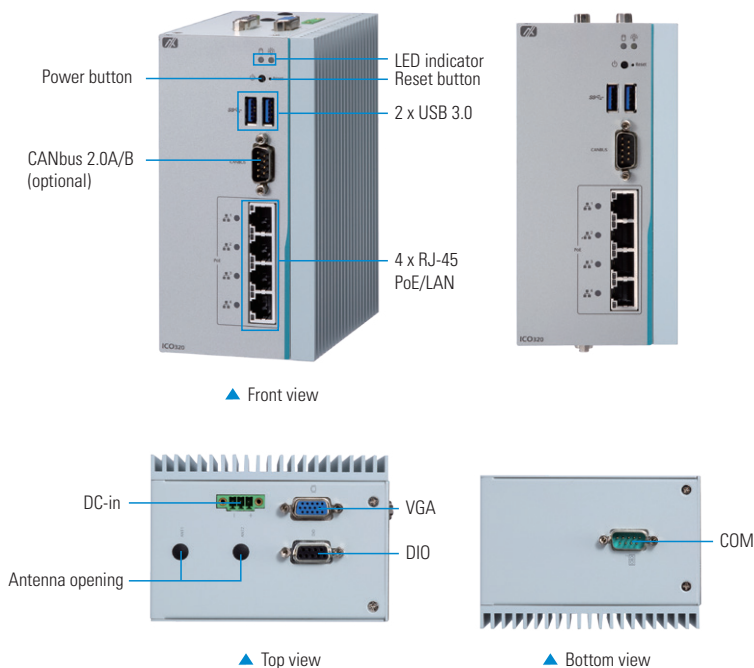

## Specifications

Standard Color	Silver
Construction	Aluminum extrusion and heavy-duty steel, IP40
CPU	Intel® Celeron® processor N3350 (1.1 GHz, Dual Core)
Chipset	SoC integrated
System Memory	1 x DDR3L SO-DIMM slot, up to 8GB
LED indicator	1 x System power 1 x HDD active 4 x PoE power #1 to #4 (optional)
BIOS	AMI
System I/O Outlet	Serial 2 x RS-232/422/485 Interface select by BIOS Supports Auto Flow Control in RS-485 mode RTC Battery onboard USB 2 x USB 3.0 Storage 2.5" SATA drive (9.5 mm height) Half-size mSATA shared with mPCIe slot LAN 4 x RJ-45 LAN 4 x RJ-45 gigabit PoE (optional); 802.3at 30W by 4 ports (Intel® i211-AT for IC0320-83C) (Intel® i210-IT for IC0320-83C-WT) Display 1 x VGA DIO 1 x DI/DO (8-bit programmable, DB9 female connector) Voltage is 5V TTL-level Input/output is programmable (per-bit) I/O sink/source current is 10mA max. (per-bit) CAN 1 x CAN 2.0 A/B (DB9 connector) (optional) Power Input 1 x DC power input with terminal block

Expansion Interface	1 x Full-size PCI Express Mini Card slot with SIM slot (for wireless module ) 1 x Half-size PCI Express Mini Card slot with mSATA (for wireless module or half size mSATA)
Watchdog Timer	255 levels, 1 to 255 sec.
Power Supply	PoE version: 12 to 24 VDC, 4.89 to 2.45A (58.68W to 58.88W) LAN version: 12 to 24 VDC, 2.40 to 1.21A (28.80W to 29.04W) Protection: OVP (±20%), reverse protection, UVP, OCP, RPP
Power Consumption	PoE power output maximum 30W 802.3af class 2, 7.5W, max 4 ports 802.3af class 3, 15.4W, max 2 ports 802.3at class 4, 30W, max 1 port
Operating Temperature	-20°C to +70°C (-4°F to +158°F) IC0320-83C-WT: -40°C to +70°C (-40°F to +158°F)
Humidity	5% to 95%, non-condensing
Vibration Endurance	2 Grms with SSD (5 to 500Hz, random wave) 2 Grms with HDD (10 to 150Hz, sine wave)
Dimensions	PoE version: 79 mm (3.11") (W) x 110 mm (4.33") (D) x 155 mm (6.1") (H) LAN version: 48 mm (1.88") (W) x 110 mm (4.33") (D) x 155 mm (6.1") (H)
Weight	PoE version: 1.2 kg (2.2 lb)/1.70 kg (3.3 lb) LAN version: 1.0 kg (2.2 lb)/1.50 kg (3.3 lb)
Certifications	CE, FCC
EOS support	Windows® 10 IoT, AXView 2.0 Linux support package(by request)

## Ordering Information

Standard	
IC0320-83C-N3350-4POE-CAN-DC	Robust DIN-rail fanless embedded system with Intel® Celeron® processor N3350 (1.1 GHz), 1 COM + 1 CAN, PoE, 2 USB and VGA (-20°C to +70°C)
IC0320-83C-N3350-4POE-DC (P/N: E22C320104)	Robust DIN-rail fanless embedded system with Intel® Celeron® processor N3350 (1.1 GHz), 2 COM, 4 PoE, 2 USB and VGA (-20°C to +70°C)
IC0320-83C-DIO-N3350-4POE-DC	Robust DIN-rail fanless embedded system with Intel® Celeron® processor N3350 (1.1 GHz), 2 COM, 4 PoE, 2 USB, VGA and 8-bit 5V TTL DIO (-20°C to +70°C)
IC0320-83C-N3350-4LAN-CAN-DC	Robust DIN-rail fanless embedded system with Intel® Celeron® processor N3350 (1.1 GHz), 1 COM, 1 CAN, 4 GbE LAN, 2 USB and VGA (-20°C to +70°C)
IC0320-83C-N3350-4LAN-DC	Robust DIN-rail fanless embedded system with Intel® Celeron® processor N3350 (1.1 GHz), 2 COM, 4 GbE LAN, 2 USB and VGA (-20°C to +70°C)

IC0320-83C-DIO-N3350-4LAN-DC	Robust DIN-rail fanless embedded system with Intel® Celeron® processor N3350 (1.1 GHz), 2 COM, 4 GbE LAN, 2 USB, VGA and 8-bit 5V TTL DIO (-20°C to +70°C)
IC0320-83C-N3350-4POE-CAN-WT-DC (P/N: E22C320103)	Robust DIN-rail fanless embedded system with Intel® Celeron® processor N3350 (1.1 GHz), 1 COM, 1 CAN, 4 PoE, 2 USB and VGA (-40°C to +70°C)
IC0320-83C-N3350-4POE-WT-DC (P/N: E22C320102)	Robust DIN-rail fanless embedded system with Intel® Celeron® processor N3350 (1.1 GHz), 2 COM, 4 PoE, 2 USB and VGA (-40°C to +70°C)
IC0320-83C-N3350-4LAN-CAN-WT-DC (P/N: E22C320101)	Robust DIN-rail fanless embedded system with Intel® Celeron® processor N3350 (1.1 GHz), 1 COM, 1 CAN, 4 GbE LAN, 2 USB and VGA (-40°C to +70°C)
IC0320-83C-N3350-4LAN-WT-DC (P/N: E22C320100)	Robust DIN-rail fanless embedded system with Intel® Celeron® processor N3350 (1.1 GHz), 2 COM, 4 GbE LAN, 2 USB and VGA (-40°C to +70°C)

\* Specifications and certifications may vary based on different requirements.

## Dimensions

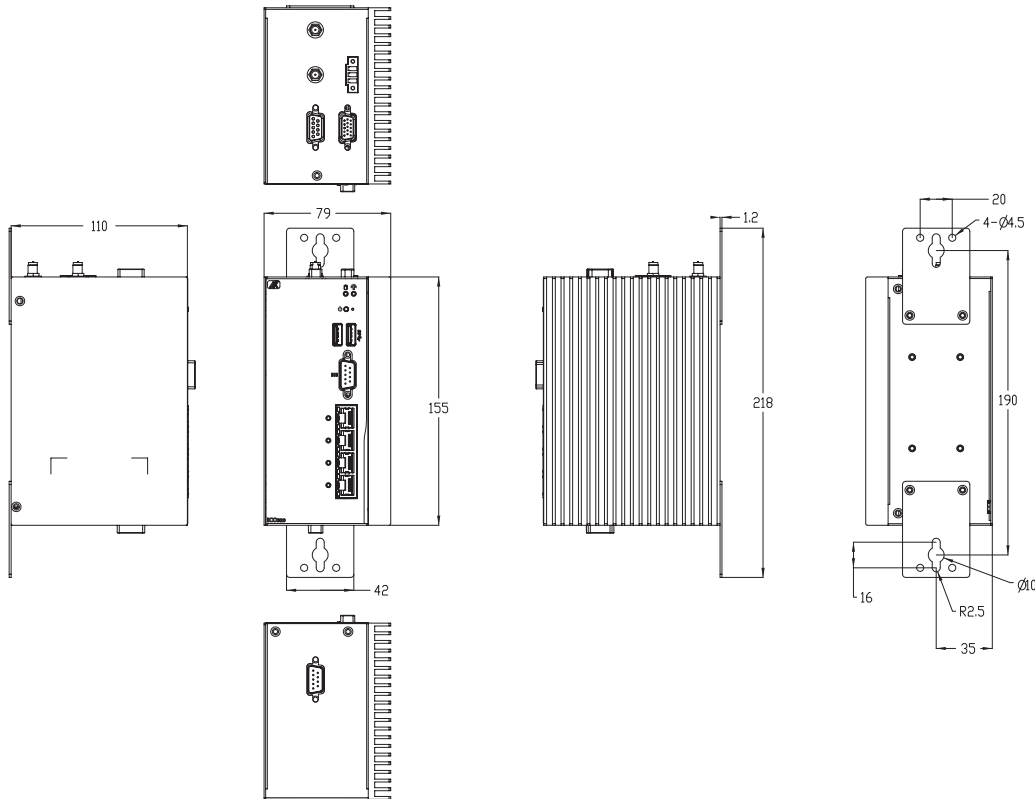

# IC0100-839

Robust DIN-rail Fanless Embedded System with Intel® Celeron® Processor N3350, 2 COM, LAN, 2 USB and DIO

## Features

- Extreme cost-effective with fanless and cableless design
- Intel® Celeron® processor N3350
- 2 COM, 2 USB and GbE LAN
- 8-bit programmable DIO for IoT gateway applications
- Wide operating temperature range from -40°C to +70°C
- 12 to 24 VDC wide range power input
- OVP, UVP, OCP, RPP power protection design
- AXView 2.0 intelligent remote monitoring software for IIoT

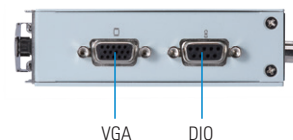
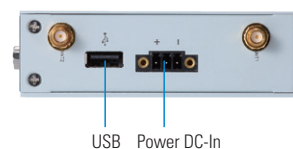
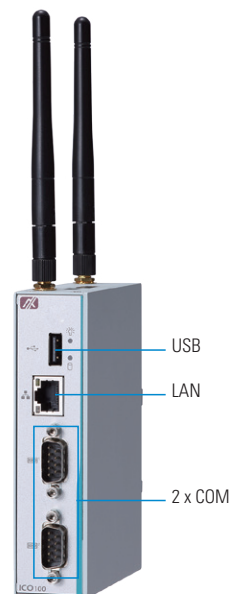

## Specifications

Standard Color	Extruded aluminum and heavy-duty steel, IP40	
Construction	Aluminum, IP40	
CPU	Intel® Celeron® processor N3350 (1.1 GHz, Dual Core)	
System Board	SBC87839	
System Memory	1 x DDR3L-1866 SO-DIMM, up to 8GB	
BIOS	AMI UEFI BIOS	
System I/O Outlet	Serial	2 x RS-232/422/485 Interface select by BIOS Supports Auto Flow Control in RS-485 mode
	RTC	Battery onboard
	USB	2 x USB 2.0
	Storage	mSATA shared with mPCIe slot (option eMMC flash onboard)
	LAN	1 x 10/100/1000 Mbps Ethernet (Intel® i211-AT for IC0100) (Intel® i210-IT for IC0100-WT) Magnetic isolation protection 1.5KV
	Display	1 x VGA (DB15 connector)
	DIO	1 x DI/DO (8-bit programmable, DB9 female connector) Voltage is 5V TTL-level Programming: I/O sink current is 10mA (max.) Input/output can be programming
	Power Input	1 x DC power input with terminal block

Extension Interface	1 x Full-size PCI Express Mini Card slot with SIM slot (for wireless module) 1 x Full-size PCI Express Mini Card slot with mSATA (for wireless module or mSATA)
Watchdog Timer	255 levels, 1 to 255 sec.
System Indicator	Power, active
Power Supply	Power Input Range: 12 to 24 VDC, 1.15 to 0.62A (13.80 to 14.88W) Protection: OVP (±20%), reverse protection
Operating Temperature	-20°C to +70°C (-4°F to +158°F) -40°C to +70°C (-40°F to +158°F) (IC0100-WT)
Humidity	10% to 95%
Vibration Endurance	2 Gms (5 to 500Hz, amplitude 0.35 mm; operation/storage/transport)
Weight (net/gross)	0.3 kg (0.67 lb)/0.46 kg (1 lb)
Certifications	CE, FCC Class A
Dimensions	31 mm (1.22") (W) x 100 mm (3.93") (D) x 125 mm (4.92") (H)
EOS Support	Windows® 10 IoT, AXView 2.0 Linux support package(by request)

## Ordering Information

Standard	
IC0100-839-N3350-DC (P/N: E22C100104)	Robust DIN-rail fanless embedded system with Intel® Celeron® processor N3350, 2 COM, LAN, 2 USB and DIO (-20°C to +70°C)
IC0100-839-N3350-WT-DC (P/N: E22C100105)	Robust DIN-rail fanless embedded system with Intel® Celeron® processor N3350, 2 COM, LAN, 2 USB and DIO (-40°C to +70°C)

Optional	
mSATA	
8812C1003A0E	IC0100/IC0120 wall mount bracket kit SFP
8816N3234A0E	3G/GPS UC20G kit for tBOX (3G ANT) (E)
8816N3235A0E	3G/GPS UC20G kit for tBOX (3G/GPS ANT) (E)
8812C3003A0E	SparkLAN WPEA-152GN Wi-Fi kit IC0 SFP (E)
8812C3004A0E	SparkLAN WPEA-251N Wi-Fi kit IC0 SFP (E)
822C3001060E	LTE SIMCOM SIM7100C (TW) for IC0300 SFP

\* Specifications and certifications may vary based on different requirements.

## Dimensions

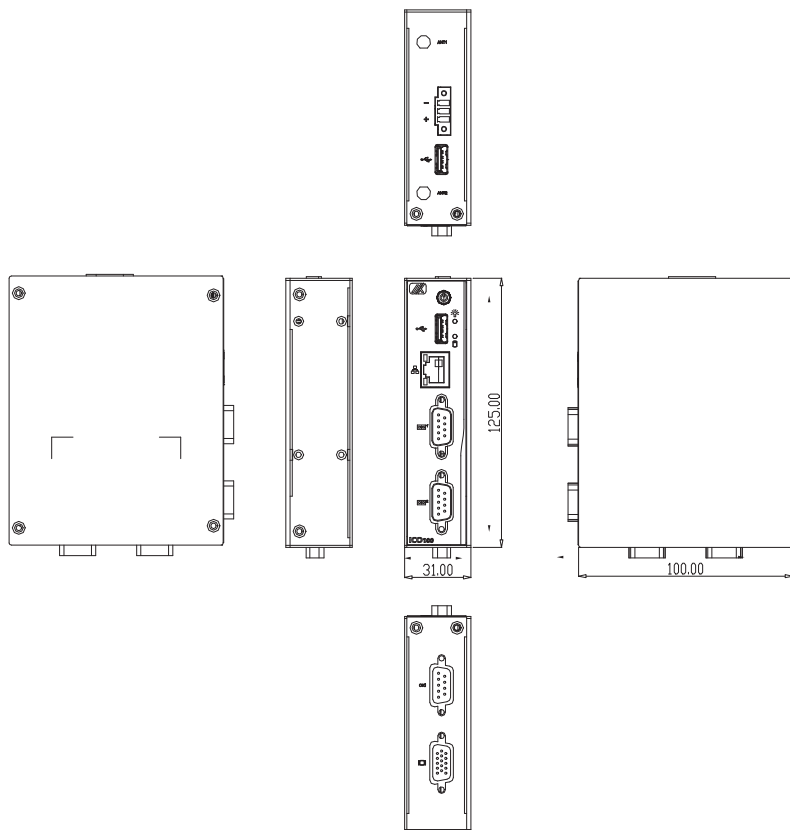

# ICO300-83B NEW

Robust DIN-rail Fanless Embedded System with Intel® Celeron® Processor N3350/  
Pentium® Processor N4200, Isolated COM, LAN and DIO Option

## Features

- Cost-effective with fanless and cableless design
- Intel® Celeron® processor N3350/Pentium® processor N4200
- 2 or 4 isolated COM, 4 USB, 2 GbE LAN
- 8-bit programmable DIO for IoT gateway applications (optional)
- Wide operating temperature range from -40°C to +70°C
- 12 to 24 VDC wide range power input
- OVP, UVP, OCP, RPP power protection design
- AXView 2.0 intelligent remote monitoring software for IIoT

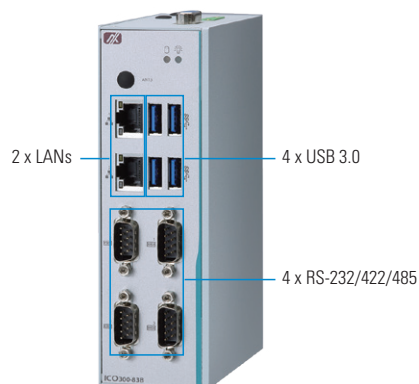

▲ Front view



▲ Rear view

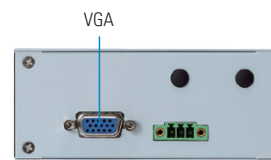

▲ Top view



## Specifications

Standard Color	Silver
Construction	Extruded aluminum and heavy-duty steel, IP40
CPU	Intel® Celeron® processor N3350 (1.1 GHz, Dual Core) Intel® Pentium® processor N4200 (1.1 GHz, Quad Core) (by request)
System Board	SBC8783B
System Memory	1 x DDR3L-1866 SO-DIMM, up to 8GB
BIOS	AMI UEFI BIOS
System I/O Outlet	Serial 4 x isolated RS-232/422/485 (ICO300-83B-4I COM) 2 x isolated RS-232/422/485 (ICO300-83B-2I COM) 4 x RS-232/422/485 (ICO300-83B-4 COM) COM port support High-speed mode up to 1.5M baud rate Interface select by BIOS Supports Auto Flow Control in RS-485 mode
USB	4 x USB 3.0
RTC	Battery onboard
Storage	2.5" SATA drive (9.5 mm height) mSATA shared with mPCIe slot
LAN	2 x 10/100/1000 Mbps Ethernet (Intel® i211-AT for ICO300-83B) (Intel® i210-IT for ICO300-83B-WT)
Display	1 x VGA or 1 x HDMI (optional)
DIO	1 x DI/DO (8-bit programmable, DB9 female connector) Voltage is 5V TTL-level ESD protection corresponds to IEC6100-4-2 (± 8KV (Air); ± 4KV (contact)) Programming: I/O sink current is 10mA (max.) Input/output can be programming
Power Input	1 x DC power input with terminal block

Extension Interface	1 x Full-size PCI Express Mini Card slot with SIM slot (for wireless module) 1 x Full-size PCI Express Mini Card slot with mSATA (for wireless module or mSATA)
Watchdog Timer	255 levels, 1 to 255 sec.
System Indicator	Power, Active
Power Supply	12 to 24 VDC, 2.82 to 1.34A (ICO300-83B-N3350) 12 to 24 VDC, 3.27 to 1.62A (ICO300-83B-N4200) Protection: OVP (±20%), reverse protection
Operating Temperature	-20°C to +70°C (-4°F to +158°F) -40°C to +70°C (-40°F to +158°F) (ICO300-83B-WT)
Humidity	10% to 95%
Vibration Endurance	2 Gms (5 to 500Hz, amplitude 0.35 mm; operation/storage/transport)
Weight (net/gross)	1.0 kg (2.2 lb)/1.50 kg (3.3 lb)
Certifications	CE, FCC
Dimensions	48 mm (1.88") (W) x 110 mm (4.33") (D) x 155 mm (6.1") (H)
EOS Support	Windows® 10 IoT, AXView 2.0 Linux support package (by request)



## Ordering Information

Standard	
IC0300-83B-N3350-4COM-DC (P/N: E22C300121)	Robust DIN-rail fanless embedded system with Intel® Celeron® processor N3350, 4 COM, 2 LAN, 4 USB and VGA (-20°C to +70°C)
IC0300-83B-N3350-4COM-WT-DC 2018 Q3 available	Robust DIN-rail fanless embedded system with Intel® Celeron® processor N3350 , 4 COM, 2 LAN, 4 USB and VGA (-40°C to +70°C)
IC0300-83B-N3350-2ICOM-DC (P/N: E22C300127)	Robust DIN-rail fanless embedded system with Intel® Celeron® processor N3350, 2 isolated COM, 2 LANs, 4 USB and VGA (-20°C to +70°C)
IC0300-83B-N3350-4ICOM-DC (P/N: E22C300123)	Robust DIN-rail fanless embedded system with Intel® Celeron® processor N3350 1.1 GHz , 4 isolated COM, 2 LANs, 4 USB and VGA (-20°C to +70°C)
IC0300-83B-N3350-4ICOM-WT-DC (P/N: E22C300119)	Robust DIN-rail fanless embedded system with Intel® Celeron® processor N3350, 4 isolated COM, 2 LANs, 4 USB and VGA (-40°C to +70°C)
IC0300-83B-N4200-4ICOM-WT-DC (P/N: E22C300120)	Robust DIN-rail fanless embedded system with Intel® Pentium® processor N4200, 4 isolated COM, 2 LANs, 4 USB and VGA (-40°C to +60°C)
IC0300-83B-N3350-2ICOM-HDMI-DC (P/N: E22C300124)	Robust DIN-rail fanless embedded system with Intel® Celeron® processor N3350 1.1 GHz , 2 isolated COM, 2 LANs, 4 USB and HDMI (-20°C to +70°C)
IC0300-83B-N3350-4ICOM-WT-HDMI-DC (P/N: E22C300126)	Robust DIN-rail fanless embedded system with Intel® Celeron® processor N3350 1.1 GHz , 4 isolated COM, 2 LANs, 4 USB and HDMI (-40°C to +70°C)
IC0300-83B-N3350-4COM-HDMI-DC (P/N: E22C300128)	Robust DIN-rail fanless embedded system with Intel® Celeron® processor N3350, 4 COM, 2 LAN, 4 USB and HDMI (-20°C to +70°C)

Optional	
mSATA	4GB and above
2.5" SATA drive	
DDR3L SO-DIMM	2GB to 8GB
8812C3000A0E	IC0300/310/320 wall mount bracket kit
8816N3234A0E	3G/GPS UC20G kit for tBOX (3G ANT) (E)
8816N3235A0E	3G/GPS UC20G kit for tBOX (3G/GPS ANT) (E)
8812C3003A0E	SparkLAN WPEA-152GN Wi-Fi kit ICO SFP (E)
8812C3004A0E	SparkLAN WPEA-251N Wi-Fi kit ICO SFP (E)

\* Specifications and certifications may vary based on different requirements.

## Dimensions

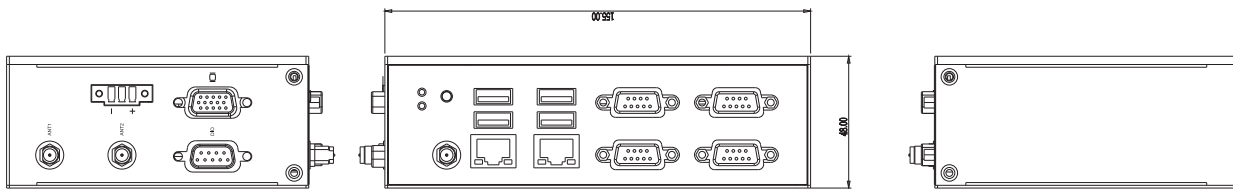

(IC0300-83B-DIO)

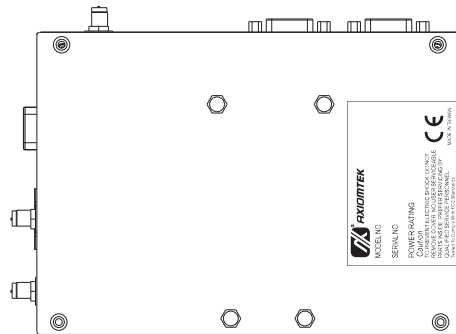

# ICO300

Robust DIN-rail Fanless Embedded System with Intel® Atom® Processor E3815/E3827, 4 COM, 2 LANs, DIO and RTC

## Features

- Fanless and compact design
- Intel® Atom® processor E3815 or E3827
- 4 RS-232/422/485 ports
- 2 isolated 10/100/1000 Mbps Ethernet ports
- 1 DIO port
- 1 PCI Express Mini Card slot (3G/GPRS or Wi-Fi)
- 1 CF (or mSATA) and SATA SSD (or HDD)
- 12 to 24 VDC wide range power input
- Supports Windows® 10 IoT solution

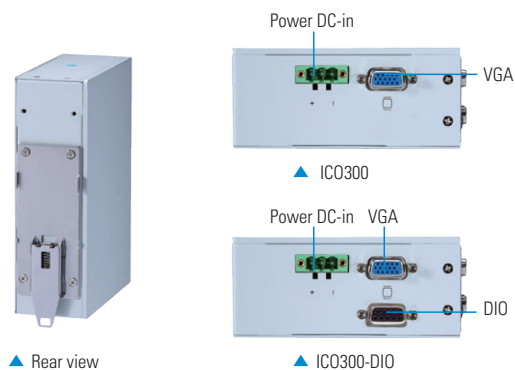
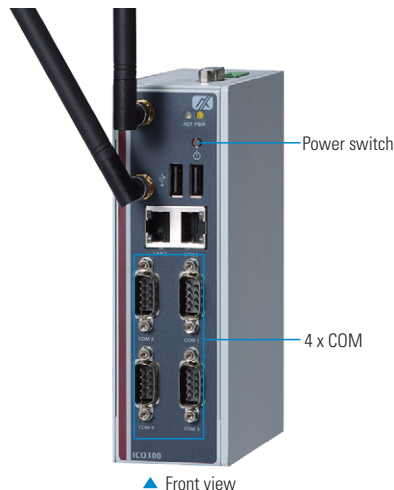

## Specifications

Standard Color	Silver																		
Construction	Extruded aluminum and heavy-duty steel, IP40																		
CPU	Intel® Atom® processor E3815 (1.46 GHz) or E3827 (1.75 GHz)																		
System Board	SBC87842																		
System Memory	1 x DDR3L-1333/1600 SO-DIMM, up to 4GB (E3815) or up to 8GB (E3827)																		
BIOS	AMI UEFI BIOS																		
System I/O Outlet	<table border="1"> <tr> <td>Serial</td> <td>4 x RS-232/422/485 (COM 1 to 4) Interface select by BIOS Supports Auto Flow Control in RS-485 mode</td> </tr> <tr> <td>RTC</td> <td>Battery onboard</td> </tr> <tr> <td>USB</td> <td>2 x USB 2.0</td> </tr> <tr> <td>Storage</td> <td>1 x CF (or mSATA*) 1 x SATA SSD (or HDD)</td> </tr> <tr> <td>LAN</td> <td>2 x 10/100/1000 Mbps Ethernet (Intel® i211-AT for ICO300) (Intel® i210-IT for ICO300-WT)</td> </tr> <tr> <td>Display</td> <td>1 x VGA</td> </tr> <tr> <td>DIO (ICO300-DIO)</td> <td>1 x DI/DO (8-bit programmable, DB9 female connector) Voltage is 5V TTL-level ESD protection corresponds to IEC6100-4-2 (± 8KV (Air); ± 4KV (contact)) Programming: I/O sink current is 10mA (max.) Input/output can be programming</td> </tr> <tr> <td>Power Input</td> <td>1 x DC power input with terminal block</td> </tr> <tr> <td>Wireless</td> <td>1 x Full-size PCI Express Mini Card slot 1 x SIM Card socket 2 x Antenna</td> </tr> </table>	Serial	4 x RS-232/422/485 (COM 1 to 4) Interface select by BIOS Supports Auto Flow Control in RS-485 mode	RTC	Battery onboard	USB	2 x USB 2.0	Storage	1 x CF (or mSATA*) 1 x SATA SSD (or HDD)	LAN	2 x 10/100/1000 Mbps Ethernet (Intel® i211-AT for ICO300) (Intel® i210-IT for ICO300-WT)	Display	1 x VGA	DIO (ICO300-DIO)	1 x DI/DO (8-bit programmable, DB9 female connector) Voltage is 5V TTL-level ESD protection corresponds to IEC6100-4-2 (± 8KV (Air); ± 4KV (contact)) Programming: I/O sink current is 10mA (max.) Input/output can be programming	Power Input	1 x DC power input with terminal block	Wireless	1 x Full-size PCI Express Mini Card slot 1 x SIM Card socket 2 x Antenna
Serial	4 x RS-232/422/485 (COM 1 to 4) Interface select by BIOS Supports Auto Flow Control in RS-485 mode																		
RTC	Battery onboard																		
USB	2 x USB 2.0																		
Storage	1 x CF (or mSATA*) 1 x SATA SSD (or HDD)																		
LAN	2 x 10/100/1000 Mbps Ethernet (Intel® i211-AT for ICO300) (Intel® i210-IT for ICO300-WT)																		
Display	1 x VGA																		
DIO (ICO300-DIO)	1 x DI/DO (8-bit programmable, DB9 female connector) Voltage is 5V TTL-level ESD protection corresponds to IEC6100-4-2 (± 8KV (Air); ± 4KV (contact)) Programming: I/O sink current is 10mA (max.) Input/output can be programming																		
Power Input	1 x DC power input with terminal block																		
Wireless	1 x Full-size PCI Express Mini Card slot 1 x SIM Card socket 2 x Antenna																		
Watchdog Timer	255 levels, 1 to 255 sec.																		

System Indicator	Power, active
Power Supply	Power input range: 12 to 24 VDC Power input rating: 12 to 24 VDC, 1.21 to 0.66A (ICO300-E3815) 12 to 24 VDC, 1.42 to 0.74A (ICO300-E3827) Power protection: DC version, OVP, Reverse protection
Operating Temperature	-20°C to +70°C (-4°F to +158°F)
Humidity	10% to 95%
Vibration Endurance	2 Gms (5 to 500Hz, amplitude 0.35 mm; operation/storage/transport)
Weight (net/gross)	1.0 kg (2.2 lb)/1.50 kg (3.3 lb)
Certifications	CE, FCC, UL
Dimensions	48 mm (1.88") (W) x 110 mm (4.33") (D) x 155 mm (6.1") (H)
EOS Support	Windows® 7 embedded Windows® 8 embedded Linux support package Windows® 10 IoT core pro

\* mSATA and wireless can be either one.

\*\* mSATA and CF can be either one.

## Ordering Information

Standard	
IC0300-E3815-PB-DC (P/N: E22C300109)	Robust DIN-rail fanless embedded system with Intel® Atom® processor E3815 1.46 GHz and 4 COM (-20°C to +70°C)
IC0300-E3827-PB-DC (P/N: E22C300110)	Robust DIN-rail fanless embedded system with Intel® Atom® processor E3827 1.75 GHz and 4 COM (-20°C to +70°C)
IC0300-E3815-DIO-PB-DC (P/N: E22C300111)	Robust DIN-rail fanless embedded system with Intel® Atom® processor E3815 1.46 GHz, 4 COM and DIO (-20°C to +70°C)
IC0300-E3827-DIO-PB-DC (P/N: E22C300112)	Robust DIN-rail fanless embedded system with Intel® Atom® processor E3827 1.75 GHz, 4 COM and DIO (-20°C to +70°C)

Optional	
CompactFlash™	4GB or above (with W.T. CF)
2.5" SATA SSD or HDD (with W.T. SSD or HDD)	
DDR3L SO-DIMM	2GB to 8GB (with W.T. memory)
8812C3000A0E	IC0300/310/320 wall mount bracket kit
8816N3234A0E	3G/GPS UC20G kit for tBOX (3G ANT) (E)
8816N3235A0E	3G/GPS UC20G kit for tBOX (3G/GPS ANT) (E)
8812C3003A0E	SparkLAN WPEA-152GN Wi-Fi kit ICO SFP (E)
8812C3004A0E	SparkLAN WPEA-251N Wi-Fi kit ICO SFP (E)
82606200390E	LTE module SIERRA MC7304 kit for EU SFP
822C3001070E	LTE SIM7100C with EXT ANT for IC0300 SFP
826N3230060E	tBOX series Bointec CPE902A Wi-Fi SFP

\* Specifications and certifications may vary based on different requirements.

## Dimensions

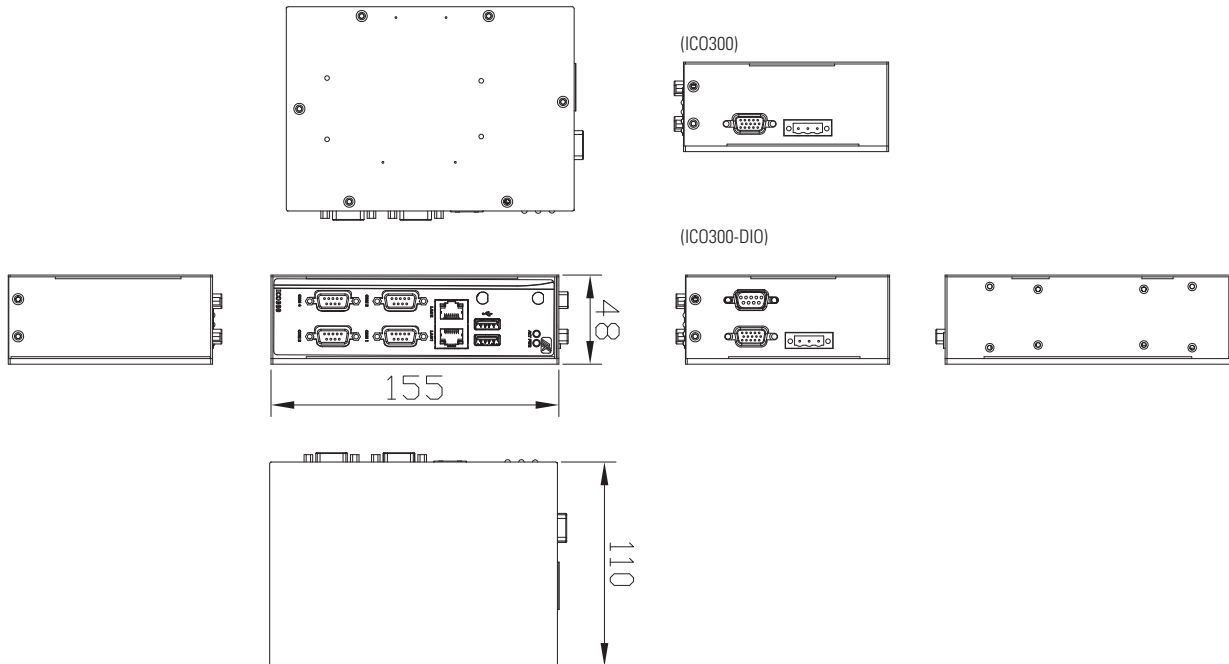

# IC0310

Robust DIN-rail Fanless Embedded System with Intel® Celeron® Processor N3060/N3160, 2 COM, 4 USB, 2 GbE LANs (1 PoE PD), DIO and RTC

## Features

- Cost-effective with fanless and cableless design
- Intel® Celeron® processor N3060 (1.6 GHz/2-core) or N3160 (1.6 GHz/4-core)
- 2 RS-232/422/485 ports
- 4 USB ports
- 2 isolated 10/100/1000 Mbps Ethernet ports
- 1 PoE PD compliant with IEEE 802.3at standard through LAN 1
- 1 DIO port
- 2 PCI Express Mini Card slots (3G/GPRS & Wi-Fi)
- 1 mSATA & SATA SSD (or HDD)
- 12 to 24 VDC wide range power input

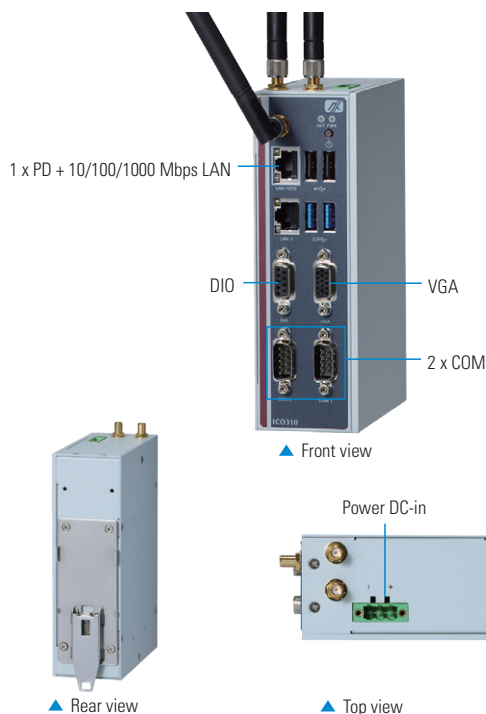

## Specifications

Standard Color	Silver																		
Construction	Extruded aluminum and heavy-duty steel, IP40																		
CPU	Intel® Celeron® processor N3060 (1.6 GHz/2-core) or N3160 (1.6 GHz/4-core)																		
System Board	SBC87887																		
System Memory	1 x DDR3L-1600 SO-DIMM, up to 8GB																		
BIOS	AMI UEFI BIOS																		
System I/O Outlet	<table border="1"> <tr> <td>Serial</td> <td>2 x RS-232/422/485 (COM 1/2) with DB9 connectors Interface select by BIOS Supports Auto Flow Control in RS-485 mode</td> </tr> <tr> <td>USB</td> <td>2 x USB 3.0 2 x USB 2.0</td> </tr> <tr> <td>RTC</td> <td>Battery onboard</td> </tr> <tr> <td>Storage</td> <td>1 x mSATA 1 x SATA SSD (or HDD)</td> </tr> <tr> <td>LAN</td> <td>2 x 10/100/1000 Mbps Ethernet (Intel® i211AT) 1 x PoE PD compliant with IEEE 802.3at standard through LAN 1 (IC0310-N3060-PD-DC, IC0310-N3160-PD-DC)</td> </tr> <tr> <td>Power Input</td> <td>DC terminal block: 12 to 24V DC-In PoE: IEEE 802.3at</td> </tr> <tr> <td>Display</td> <td>VGA (DB15 connector)</td> </tr> <tr> <td>Wireless</td> <td>1 x Full-size PCI Express Mini Card slot 1 x Full-size PCI Express Mini Card slot with mSATA 1 x SIM card socket 3 x Antenna</td> </tr> <tr> <td>DIO</td> <td>1 x DIO - DB9 8-bit programming connector - The voltage of TTL is 5V. - Without isolation function - The programming is as follow: 1. I/O sink current is 8 to 10mA (output drive current ±50 mA) 2. Input/output can programming</td> </tr> </table>	Serial	2 x RS-232/422/485 (COM 1/2) with DB9 connectors Interface select by BIOS Supports Auto Flow Control in RS-485 mode	USB	2 x USB 3.0 2 x USB 2.0	RTC	Battery onboard	Storage	1 x mSATA 1 x SATA SSD (or HDD)	LAN	2 x 10/100/1000 Mbps Ethernet (Intel® i211AT) 1 x PoE PD compliant with IEEE 802.3at standard through LAN 1 (IC0310-N3060-PD-DC, IC0310-N3160-PD-DC)	Power Input	DC terminal block: 12 to 24V DC-In PoE: IEEE 802.3at	Display	VGA (DB15 connector)	Wireless	1 x Full-size PCI Express Mini Card slot 1 x Full-size PCI Express Mini Card slot with mSATA 1 x SIM card socket 3 x Antenna	DIO	1 x DIO - DB9 8-bit programming connector - The voltage of TTL is 5V. - Without isolation function - The programming is as follow: 1. I/O sink current is 8 to 10mA (output drive current ±50 mA) 2. Input/output can programming
Serial	2 x RS-232/422/485 (COM 1/2) with DB9 connectors Interface select by BIOS Supports Auto Flow Control in RS-485 mode																		
USB	2 x USB 3.0 2 x USB 2.0																		
RTC	Battery onboard																		
Storage	1 x mSATA 1 x SATA SSD (or HDD)																		
LAN	2 x 10/100/1000 Mbps Ethernet (Intel® i211AT) 1 x PoE PD compliant with IEEE 802.3at standard through LAN 1 (IC0310-N3060-PD-DC, IC0310-N3160-PD-DC)																		
Power Input	DC terminal block: 12 to 24V DC-In PoE: IEEE 802.3at																		
Display	VGA (DB15 connector)																		
Wireless	1 x Full-size PCI Express Mini Card slot 1 x Full-size PCI Express Mini Card slot with mSATA 1 x SIM card socket 3 x Antenna																		
DIO	1 x DIO - DB9 8-bit programming connector - The voltage of TTL is 5V. - Without isolation function - The programming is as follow: 1. I/O sink current is 8 to 10mA (output drive current ±50 mA) 2. Input/output can programming																		
Watchdog Timer	255 levels, 1 to 255 sec.																		

System Indicator	Power, active, COMs (TX/RX)
Power Supply	Power input range: 12 to 24 VDC Power input rating: 12 to 24 VDC, 2.09 to 1.09A Power protection: DC version OVP, reverse protection
Operating Temperature	-20°C to +60°C (-4°F to +140°F) *The frequency of CPU will down when system operating temperature over +55°C (IC0310-N3060, IC0310-N3060-PD, IC0310-N3160) or over +50°C (IC0310-N3160-PD)
Humidity	10% to 95%
Vibration Endurance	2 Gms (5 to 500Hz, amplitude 0.35 mm; operation/storage/transport)
Weight	1.0 kg (2.2 lb)/1.50 kg (3.3 lb)
Certifications	CE, FCC
Dimensions	48 mm (1.88") (W) x 110 mm (4.33") (D) x 155 mm (6.1") (H)
Mounting	DIN-rail, wall mount
OS Support	Windows® 7 Embedded Windows® 8 Embedded Windows® 8, Windows® 10 Linux support package
Remote Management Software	AXView 2.0 Intelligent Remote Management Solution for IoT

\* mSATA and wireless can be either one.

## Ordering Information

Standard	
IC0310-N3060-DC (P/N: E22C310106)	Robust DIN-rail fanless embedded system with Intel® Celeron® processor N3060 (1.6GHz/DC), 2 COM, 2 LAN, and DIO (-20°C to +60°C with power button)
IC0310-N3060-PD-DC (P/N: E22C310107)	Robust DIN-rail fanless embedded system with Intel® Celeron® processor N3060 (1.6GHz/DC), 2 COM, 2 LANs, PoE PD, and DIO (-20°C to +60°C with power button)
IC0310-N3160-PB-DC (P/N: E22C310104)	Robust DIN-rail fanless embedded system with Intel® Celeron® processor N3160 (1.6GHz/QC), 2 COM, 2 LANs, and DIO (-20°C to +60°C with power button)
IC0310-N3160-PD-DC (P/N: E22C310105)	Robust DIN-rail fanless embedded system with Intel® Celeron® processor N3160 (1.6GHz/QC), 2 COM, 2 LANs, PoE PD, and DIO (-20°C to +60°C with power button)

Optional	
2.5" SATA SSD or HDD (with W.T. SSD or HDD)	
mSATA	16GB to 512GB (with W.T. mSATA)
DDR3L SO-DIMM	2GB to 8GB (with W.T. memory)
8812C3000A0E	IC0300/310/320 wall mount bracket kit
8816N3234A0E	3G/GPS UC20G kit for tBOX (3G ANT) (E)
8816N3235A0E	3G/GPS UC20G kit for tBOX (3G/GPS ANT) (E)
8812C3003A0E	SparkLAN WPEA-152GN Wi-Fi kit ICO SFP (E)
8812C3004A0E	SparkLAN WPEA-251N Wi-Fi kit ICO SFP (E)
82606200390E	LTE module SIERRA MC7304 kit for EU SFP
826N3230060E	tBOX series Bointec CPE902A Wi-Fi SFP

\* Specifications and certifications may vary based on different requirements.

## Dimensions

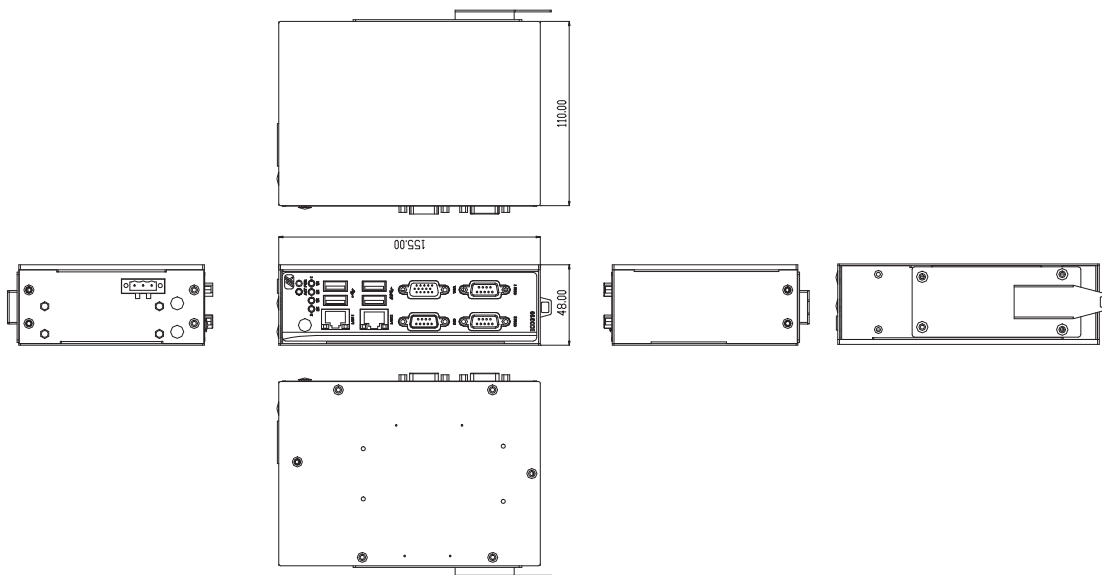



# IC0500-518 NEW

Fanless Embedded System with 7th Gen Intel® Core™ i7/i5/i3 & Celeron® Processor, and Dual Modular I/O Expansion Design

## Features

- 7th gen Intel® Core™ i7/i5/i3 & Celeron® processors (Kaby Lake-U)
- 2 PIM (Plug-in I/O Module) slots
- Fanless and compact design
- Wide operating temperature range from -40°C to +70°C
- 12 to 48 VDC wide range power input
- OVP, UVP, OCP, RPP power protection design
- 1 swappable 2.5" SATA drive tray

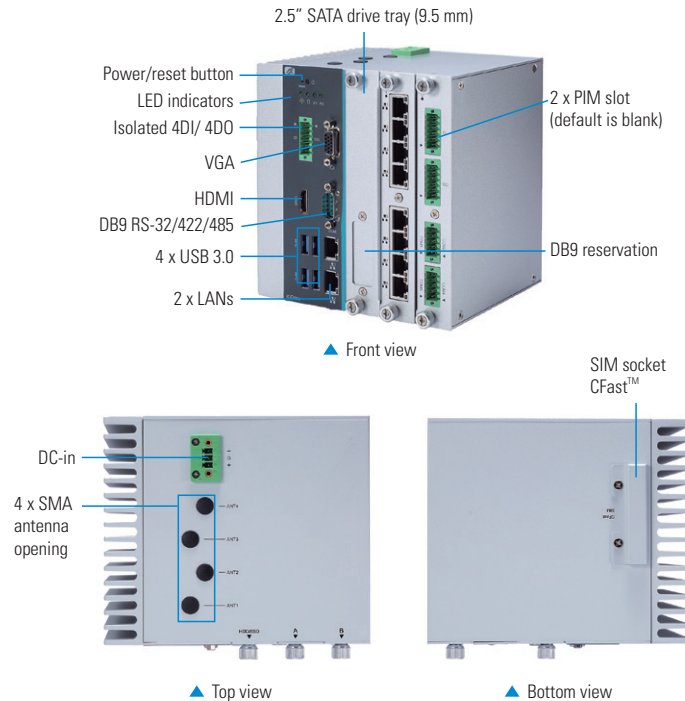
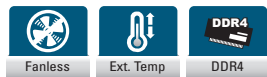

## Specifications

Standard Color	Silver						
Construction	Aluminum extrusion and heavy-duty steel, IP40						
CPU	Intel® Core™ i7-7600U 2C @ 2.8GHz Intel® Core™ i5-7300U 2C @ 2.6GHz Intel® Core™ i3-7100U 2C @ 2.4 GHz Intel® Celeron® 3965U 2C @ 2.2 GHz						
System Memory	1 x DDR4-1866/2133 SO-DIMM, up to 16GB						
Chipset	SoC integrated						
BIOS	AMI						
System I/O Outlets	<table border="0"> <tr> <td>Top Side</td> <td>1 x DC power input with terminal block 4 x Antenna opening</td> </tr> <tr> <td>Bottom Side</td> <td>External SIM slot&amp; CFast card</td> </tr> <tr> <td>Front Side</td> <td>1 x HDMI 2 x GbE LAN 4 x USB 3.0 1 x VGA 1 x DB9 RS-232/422/485 1 x Isolated DIO (4-in/4-out) 1 x 2.5" SATA drive tray 2 x PIM slot</td> </tr> </table>	Top Side	1 x DC power input with terminal block 4 x Antenna opening	Bottom Side	External SIM slot& CFast card	Front Side	1 x HDMI 2 x GbE LAN 4 x USB 3.0 1 x VGA 1 x DB9 RS-232/422/485 1 x Isolated DIO (4-in/4-out) 1 x 2.5" SATA drive tray 2 x PIM slot
Top Side	1 x DC power input with terminal block 4 x Antenna opening						
Bottom Side	External SIM slot& CFast card						
Front Side	1 x HDMI 2 x GbE LAN 4 x USB 3.0 1 x VGA 1 x DB9 RS-232/422/485 1 x Isolated DIO (4-in/4-out) 1 x 2.5" SATA drive tray 2 x PIM slot						
Watchdog Timer	255 levels, 1 to 255 sec.						
Storage	1 x Swappable 2.5" SATA drive (9.5 mm height) ** DIN-rail mounting with SSD 1 x External CFast card						
Expansion Interface	2 x Full-size PCI Express Mini Card slot 1 x External SIM card slot						
System Indicator	1 x LED indicator for system power 1 x LED indicator for HDD activities 2 x Programmable						
Power Supply	12 to 48 VDC, OVP, UVP, OCP, RPP power protection design						
Operating Temperature	-40°C to +70°C (-40°F to +158°F) -40°C to +60°C (-40°F to +140°F) with PIM200						
Humidity	10% to 95%, non-condensing						
Vibration Endurance (operational)	3 Grms with SSD, DIN-rail/wall mounting (5 to 500Hz, X/Y/Z direction; random)						
Weight (net/gross)	TBC						
Certifications	CE (Class A), FCC						

Dimensions	145 mm (5.70") (W) x 125 mm (4.92") (D) x 155 mm (6.10") (H)
EOS Support	Windows® 10 Linux support package
Remote Management Software	AXView 2.0/3.0 Intelligent Remote Management Solution for IoT
Mounting	DIN-rail (standard) Wall mount (optional)

## Ordering Information

Standard	
IC0500-518-Celeron	Fanless embedded system with Intel® Celeron® 3965U 2.2 GHz processor, 4 USB 3.0, 2 RJ-45 LAN, COM, DIO (4-in/4-out), 2.5" SATA tray, HDMI, VGA
IC0500-518-i3	Fanless embedded system with Intel® Core™ i3-7100U 2.4 GHz processor, 4 USB 3.0, 2 RJ-45 LAN, COM, DIO (4-in/4-out), 2.5" SATA tray, HDMI, VGA
IC0500-518-i5	Fanless embedded system with Intel® Core™ i5-7300U 2.6GHz processor, 4 USB 3.0, 2 RJ-45 LAN, COM, DIO (4-in/4-out), 2.5" SATA tray, HDMI, VGA
IC0500-518-i7	Fanless embedded system with Intel® Core™ i7-7600U 2.8GHz processor, 4 USB 3.0, 2 RJ-45 LAN, COM, DIO (4-in/4-out), 2.5" SATA tray, HDMI, VGA

## Ordering Information

### I/O Modules

PIM100 8 x isolated, 4-wire COM (RS-232/422/485)



PIM101 8 x isolated CANbus 2.0 A/B



PIM200 4 x isolated, 4-wire COM (RS-232/422/485) & isolated 8-in/8-out DIO



PIM700 8 x RJ-45 Gb Ethernet



### Optional

2.5" SATA SSD	16GB or above
CFast™	16GB or above
DDR4 SO-DIMM	4GB to 16GB

\* Specifications and certifications may vary based on different requirements.

## Dimensions

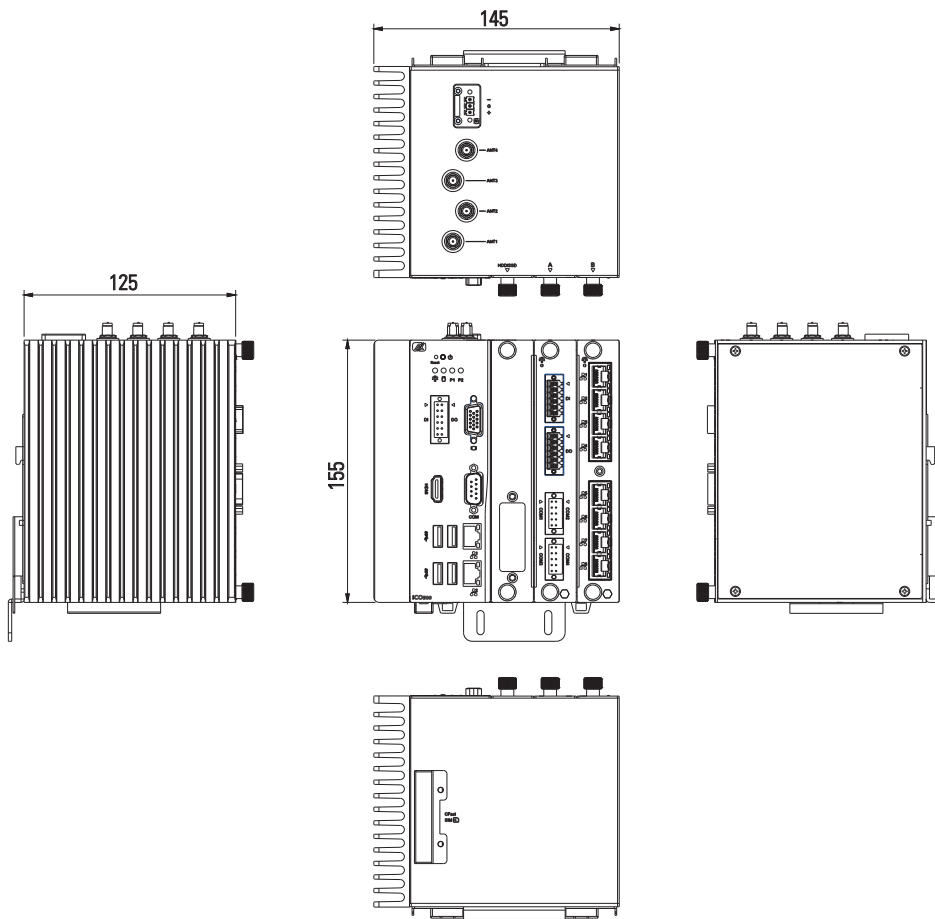

# rBOX510-6COM(ATEX/C1D2)

ATEX & CID2 Anti-Explosion Certified Robust DIN-rail Fanless Embedded System with Intel® Atom® Processor E3827

## Features

- ATEX & CID2 anti-explosion certification
- Fanless and cableless design
- Intel® Atom® processor E3827 (1.75 GHz) dual core
- Wide operating temperature range from -40°C to +70°C
- 4 isolated RS-232/422/485 ports & 2 RS-232/422/485 ports
- 2 isolated 10/100/1000 Mbps Ethernet ports
- 2 watchdog timer
- RTC Battery function
- LED indicators
- One 2.5" SATA SSD and one CompactFlash™
- Power input range of 9V to 48V DC with terminal block
- AXView 2.0 intelligent remote monitoring software for IIoT

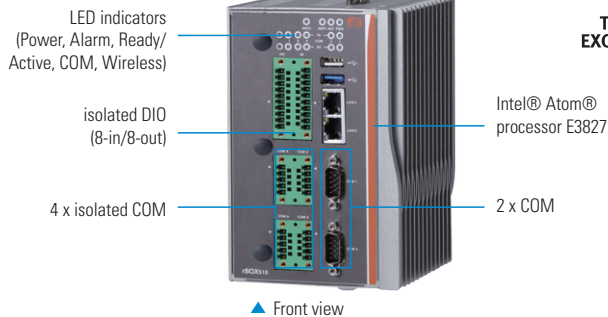

## Specifications

Standard Color	Sliver-black
Construction	Extruded aluminum and heavy-duty steel, IP30
CPU	Intel® Atom® processor E3827 (1.75 GHz) dual core
System Board	CEM840
System Memory	DDR3L 4GB onboard
BIOS	AMI UEFI BIOS
System I/O Outlet	Serial 2 x RS-232/422/485 4 x Isolation RS-232/422/485 Interface select by software or BIOS Supports Auto Flow Control in RS-485 mode ESD protection 15KV Magnetic isolation protection 2KV COM 1 & 2 speed up to 115.2kbps COM 3 to 6 serial port speed up to 921.6kbps
RTC	Battery onboard & Gold capacity onboard (1st backup battery when power shut-down)
USB	1 x USB 3.0 1 x USB 2.0 USB power distribution control by software
Storage	1 x 2.5" SATA SSD 1 x CompactFlash™ (easy-to-access)
LAN	2 x 10/100/1000 Mbps (Intel® i210-IT) Magnetic isolation protection 1.5 KV
Display	1 x VGA (DB15 connector)
DIO	N/A
CAN	N/A
Power Input	1 x DC power input with terminal block



System I/O Outlet	DIO	1 isolated DIO (8-in/8-out) DI: Input Channels: 8 source type Input Voltage: 0 to 30VDC Digital input Digital Input levels for dry/wet contacts DO: Output Channels: 8 sink type Output Current: Max. 200mA per channel External Voltage: 10 to 30 VDC Open collector to 30V Optical isolation protection 3 KV
Watchdog Timer	255 levels, 1 to 255 sec.	
System Indicator	Power, Alarm, Ready/Active, COM, Wireless	
Power Supply	Power Input Range : 12 to 48 VDC Power Input Rating : 12 to 48 VDC, 1.36 to 0.45A Power Protection : DC version, OVP, UVP, Reserve Protection	
Operating Temperature	-40°C to +70°C (-40°F to +158°F)	
Humidity	10% to 95%	
Vibration Endurance	5 Gms (10 to 150Hz, amplitude 0.35 mm; operation/storage/transport)	
Weight (net/gross)	1.5 kg (3.3 lb)/1.88 kg (4.14 lb)	
Dimensions	100.6 mm (3.96") (W) x 110 mm (4.33") (D) x 135 mm (5.31") (H)	
EOS Support	Windows® 7 Embedded, Windows® 8 Embedded Linux support package	
Remote Management Software	AXView 2.0 Intelligent Remote Management Solution for IIoT - Local Hardware Monitoring - Local SRAM Backup - Remote Management - Store Apps - Service Cloud - SNMP, MQTT, MODBUS, SNMP Trap & Email	

\* W.T.: Wide Temperature. All W.T. supported products have to be sorted by Axiomtek.

## Specifications

ISO	Manufactured in an ISO 9001 facility
Anti-Explosive	ATEX & C1D2 Anti-Explosive Type "nA" Zone 2 Group II & class I, Division 2 Certification
Safety	UL 60950-1 Heavy Industrial CE, including: EN 60950-1, IEC 60950-1
EMI	FCC Part 18 Heavy Industrial CE, including: EN 61000-6-4, EN 61000-3-2, EN 61000-3-3
EMS	Heavy Industrial CE, including: EN 61000-6-2 EN 61000-4-2 (ESD standards) *Contact: +/- 6 KV; criteria B *Air: +/- 8 KV; criteria B EN 61000-4-3 (radiated RFI standards) *10V/m, 80 to 1000 MHz; 80% AM criteria A *1400 to 2000 MHz, 3 V/m, 80% AM (1 kHz) *2000 to 2700 MHz, 1 V/m, 80% AM (1 kHz) EN 61000-4-4 (burst standards) *Signal ports: +/- 2 KV; criteria B *DC power ports: +/- 2 KV; criteria B EN 61000-4-5 (surge standards) *Signal ports: +/- 1 KV; line-to-line; criteria B *DC power ports: +/- 0.5 KV; line-to-earth; criteria B EN 61000-4-6 (induced RFI standards) *Signal ports: 10 Vrms @ 0.15 to 80 MHz; 80% AM criteria A *DC power ports: 10 Vrms @ 0.15 to 80 MHz; 80% AM criteria A EN 61000-4-8 (magnetic field standards) *30 A/m @ 50, 60 Hz; criteria A
Environmental Test Compliance	IEC 60068-2-6 Fc (vibration resistance) 5 g @ 10 to 150 Hz, amplitude 0.35 mm (operation/storage/transport) IEC 60068-2-27 Ea (shock) 25 g @ 11 ms (half-sine shock pulse; operation); 50 g @ 11 ms (half-sine shock pulse; storage/transport) IEC 60068-2-32 Ed (free fall) 1 M (3.281ft)

## Ordering Information

Standard	
rBOX510-6COM-FL-DC (P/N: E26M510100)	Robust DIN-rail fanless embedded system with Intel® Atom™ Processor E3827 (1.75GHz), 6 COM, SATA, SSD, DIO, 2 LANs, and RTC
rBOX510-6COM-FL-DC (ATEX/C1D2) (P/N: E26M510101)	Robust ATEX/C1D2 DIN-rail fanless embedded system with Intel® Atom™ processor E3827 1.75 GHz dual core, DDR3L 4GB onboard and 6 COM (-40°C to +70°C)
Optional	
CompactFlash™	8 GB or above (with W.T. CF)
2.5" SATA SSD	
Wall mount kit	

\* Specifications and certifications may vary based on different requirements.

## Dimensions

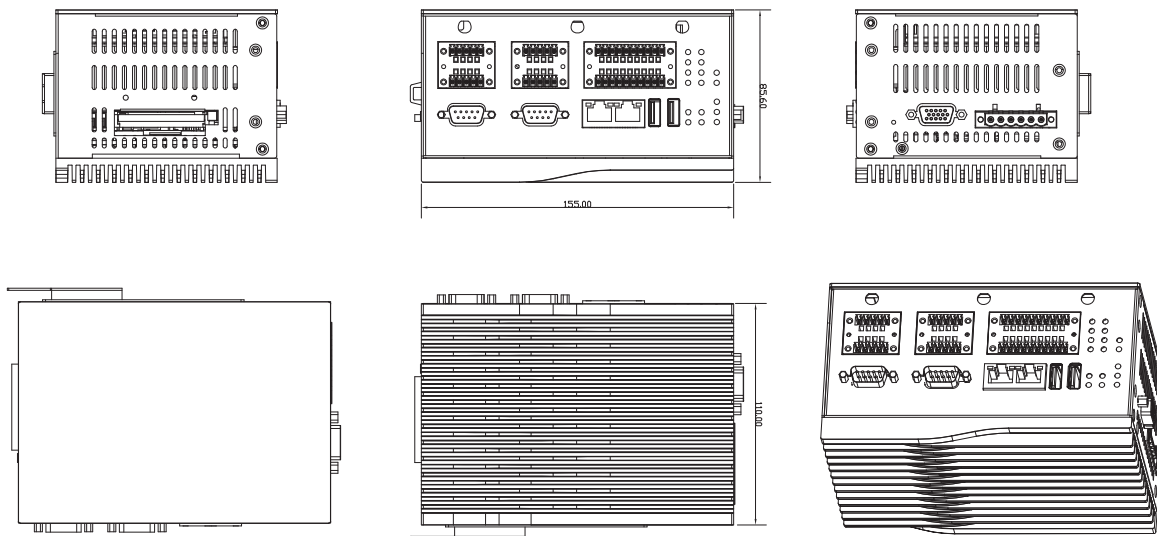

# IRU152

Robust RISC-based DIN-rail Fanless Embedded System with i.MX 6UL Processor, COM, LAN, DIO (2-in/2-out), 4 AI Channels (16-bit, 250 kS/s) and 2 PCIe Mini Card Slots

## Features

- RISC-based (i.MX 6UltraLite) processor 528 MHz
- 512MB DDR3 SDRAM onboard
- 8GB eMMC flash onboard
- 2 PCI Express Mini Card slots (Wi-Fi, 3G/4G or LoRa)
- 4 isolated analog input channels (16-bit, 250 kS/s)
- 1 isolated COM port
- 1 isolated DIO (2-in/2-out)
- Embedded Linux operating system (Yocto)
- Wide operating temperature range from -40°C to +70°C
- Supports LabVIEW versions later than 2016
- Supports OPC UA



## Introduction

The IRU152 DIN-rail fanless embedded system utilizes a low power RISC-based (i.MX 6UL) processor, one RS-232/422/485 serial port, one LAN, two digital input channels, two digital output channels, four analog input channels, designed to withstand temperatures ranging from -40°C to +70°C for applications in extreme operating environment and industrial automation.

The IRU152 is an Ethernet-based gateway supporting two wireless sockets (Wi-Fi, 3G/4G or LoRa), acting as a simple transparent interface between Ethernet-based network and Modbus devices such as meters, monitors, protective relays, trip units, motor controls and other devices that communicate using Modbus protocol.

Also, the IRU152 can record digital/analog signal of devices and control digital devices. It can offer a simple, scalable web-based monitoring solution providing real-time data views, on-board data logging/trending, and simple control over Modbus devices. Embedded math function such as RMS and FFT are used to make advanced diagrams. The ready-to-run IRU152 is specially designed for remote control/monitoring management applications ideal in a unmanned control room, an industrial machine, an automatic parking lot, a traffic cabinet, just to name a few.

## Specifications

Construction	Extruded aluminum and heavy-duty steel, IP40	
CPU	NXP i.MX 6 UL processor, ARM® Cortex®-A7 @ 528 MHz	
System Memory	1 x DDR3-1600 onboard, 512 MB	
System I/O Outlet	Serial Port	1 x RS-232/422/485 Magnetic isolation protection 2KV
	LAN	1 x 10/100 Mbps Ethernet Magnetic isolation protection 1.5KV
	Analog Input	4 x AI (isolation) channels: 4 Input type differential Input range: (software programmable) Unipolar: 0 to 10V, 0 to 5V Bipolar: ±10V, ±5V Resolution: 16-bit Sampling rate: 10 S/s to 250 kS/s FIFO buffer size: 2,048 samples Overvoltage protection: ±55V Trigger source: Analog or digital (software selectable)
	USB	1 x USB 2.0 (type A)
	DIO	1 x DIO (2-in/2-out) with isolation 2KV DI: wet/dry DO: wet



System I/O Outlet	DIO	DI: Input channels: 2 source type Input voltage: 0 to 30 VDC digital input levels for dry contacts: -Logic level 0: close to GND -Logic level 1: open Digital input levels for wet contacts: -Logic level 0: +10V to +24V (DI to COM) -Logic level 1: +3V max. DO: Output channels: 2, sink type Output current: max. 200 mA per channel On-state voltage: 24VDC nominal, open collector to 30V Optical isolation protection 2 KV
	Console Port	Yes For user setting with debug
	EEPROM	1 x EEPROM (2 Kb)
	Device ID	ID setting 0 to 255
	Wireless	2 x PCI Express Mini Card slot (only USB signal) 1 x SIM Card socket
	Watchdog Timer	WDT 1: 0.5 to 128 sec. with a time resolution of 0.5 sec.
	RTC	Yes (RTC battery on board)
	LEDs	2 x LED for dual wireless status 2 x LED for DI status 2 x LED for DO status
	Storage	1 x eMMC 8GB flash onboard
	Power Supply	9 to 48 VDC power input range
Operating Temperature	-40°C to +70°C (-40°F to +158°F)	
Storage Temperature	-45°C to +85°C (-49°F to +185°F)	
Humidity	10% to 95%	
Vibration Endurance	2 Gms @ (10 to 150Hz sine wave; operation)	
Dimensions	55 mm (2.16") (W) x 82 (3.23") mm (D) x 108 (4.25") (H)	
Weight (net/gross)	0.32 kg (0.71 lb)/0.53 kg (1.17 lb)	
Installation	DIN-rail	
Certifications	FCC part 15, Heavy Industrial CE	



## Wireless

4G module	4G Mini card LTE SIERRA AIRPRIME MC7304 (Option)	Standards: LTE Cat.3 Interface: USB Radio Band/ Frequencies (MHz): 850(5) / 900(8) / 1800(3) / 1900(2) @GSM 850(5) / 900(8) / 1900(2) / 2100(1) @UMTS 800(20) / 900(8) / 1800(3) / 2100(1) / 2600(7) @FDD LTE Region: Global
Wi-Fi module	Wi-Fi Mini card Sparklan WPEQ-160ACN (Option)	Qualcomm Atheros QCA9377-7 Antenna:2xUFL connectors, 1T1R Operating Frequency: 802.11 ac/a/b/g/n ISM Band 2.412 GHz to 2.472 GHz 5.180 MHz to 5.825 MHz Interface: USB Region: Global
3G module	3G Mini card Quectel UC20G (Option)	UMTS:800/ 850/ 900/ 1900/ 2100MHz GSM/EDGE 850/ 900/1800/ 1900MHz Region: Global
4G module	4G Mini card LTE RYR2800 (uBlox R280) (Option)	Standards: LTE Cat.1 Interface: USB Radio Band/ Frequencies (MHz): LTE bands1, 3,5,7,8,28) Region: TW, AU
	4G Mini card LTE RYR2110 (uBlox R211) (Option)	Standards: LTE Cat.1 Interface: USB Radio Band/ Frequencies (MHz): LTE bands1, 3,7,20) Region: EU

## Packing list

- 1 x CD
- 8 x Screws
- 1 x Din-rail kit
- 1 x 4-pin terminal block for power port
- 1 x 14-pin terminal block for DIO/AI port

## Dimensions

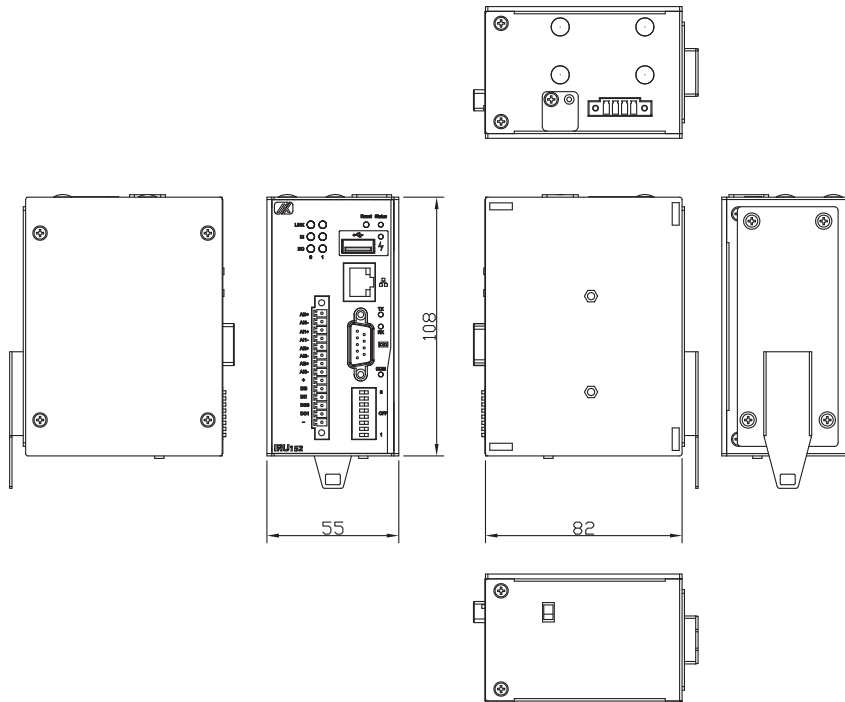

## Software Specifications

OS	Linux Kernel 3.14.52 Yocto FIDO 1.8
Protocol Types	ICMP, TCP/IP, UDP, ARP, Telnet, SNMP, HTTP, HTTPS, SSL, SMTP, FTP, TFTP NTP, DNS, PPP, PPPoE, DHCP, NFS
Software Types	Serial Server Supports TCP Server/TCP Client/ UDP/Pair/VC Supports IP filter Supports 32 TCP connections
	Modbus Supports Modbus TCP/Modbus RTU/Modbus ASCII Supports TCP for multiple COM port
Setting Configuration	SNMP Supports V1/V2C/V3 Supports SNMP Private MIB Supports read/write
	http /https Supports SSL Supports import/export Supports FW update
	Remote Manager Remote log Email SNMP Supports trap
Alert Function	Yes

## Ordering Information

### Standard

IRU152-FL-DC (P/N: E271152100)	Robust DIN-rail fanless embedded system with i.MX 6UL processor, COM, LAN, DIO (2-in/2-out), 4 AI (16-bit, 250 kS/s) and 2 PCIe Mini Card slot
-----------------------------------	--

### Optional

Wireless (3G/GPS or Wi-Fi) module
-----------------------------------

# IRU151

Robust RISC-based DIN-rail Fanless Embedded System with i.MX 6UL Processor, COM, LAN, DIO (2-in/2-out), 4 AI Channels (16-bit, 100 S/s) and 2 PCIe Mini Card Slots

## Features

- RISC-based (i.MX 6UltraLite) processor 528 MHz
- 512MB DDR3 SDRAM onboard
- 8GB eMMC flash onboard
- 2 PCI Express Mini Card slots (Wi-Fi, 3G/4G or LoRa)
- 4 isolated analog input channels (16-bit, 100 S/s)
- 1 isolated COM port
- 1 isolated DIO (2-in/2-out)
- Embedded Linux operating system (Yocto)
- Wide operating temperature range from -40°C to +70°C
- Supports LabVIEW versions later than 2016
- Supports OPC UA

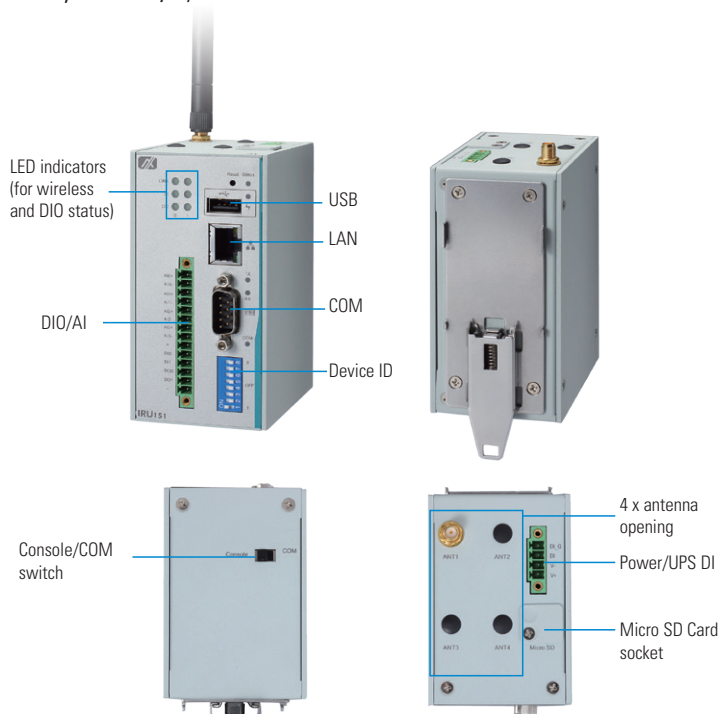

## Introduction

The IRU151 DIN-rail fanless embedded system utilizes a low power RISC-based (i.MX6 UL) processor, one RS-232/422/485 serial port, one LAN, two digital input channels, two digital output channels, four analog input channels, designed to withstand temperatures ranging from -40°C to +70°C for applications in extreme operating environment and industrial automation.

The IRU151 is an Ethernet-based gateway supporting two wireless sockets (Wi-Fi, 3G/4G or LoRa), acting as a simple transparent interface between Ethernet-based network and Modbus devices such as meters, monitors, protective relays, trip units, motor controls and other devices that communicate using Modbus protocol.

Also, the IRU151 can record digital/analog of devices and control digital devices. It can offer a simple, scalable web-based monitoring solution providing real-time data views, on-board data logging/trending, and simple control over Modbus devices. Embedded math function such as RMS and FFT are used to make advanced diagrams. The ready-to-run IRU151 is specially designed for remote control/monitoring management applications ideal in a unmanned control room, an industrial machine, an automatic parking lot, a traffic cabinet, just to name a few.

## Specifications

Construction	Extruded aluminum and heavy-duty steel, IP40	
CPU	NXP i.MX 6UL processor, ARM® Cortex®-A7 @ 528 MHz	
System Memory	1 x DDR3-1600 onboard, 512 MB	
System I/O Outlet	Serial Port	1 x RS-232/422/485 Magnetic isolation protection 2KV
	LAN	1 x 10/100 Mbps Ethernet Magnetic isolation protection 1.5KV
Analog Input	4 x AI (Isolation) channels: 4	Input type differential Input range: (software programmable) Bipolar : ±5V, ±10V Resolution: 16-bit Sampling rate : 100 S/s Overvoltage protection : ±55V Trigger source : analog or digital (software selectable)
	USB	1 x USB 2.0 (type A)
DIO	1 x DIO (2-in/2-out) with isolation 2KV DI: wet/dry DO: wet	

System I/O Outlet	DIO	DI: Input channels: 2 source type Input voltage: 0 to 30 VDC digital input levels for dry contacts: -Logic level 0: close to GND -Logic level 1: open Digital input levels for wet contacts: -Logic level 0: +10V to +24V (DI to COM-) -Logic level 1: +3V max. DO: Output channels: 2, sink type Output current: max. 200 mA per channel On-state voltage: 24VDC nominal, open collector to 30V Optical isolation protection 2 KV
	Console Port	Yes For user setting with debug
EEPROM	1 x EEPROM (2 Kb)	
Device ID	ID setting 0 to 255	
Wireless	2 x PCI Express Mini Card slot (USB signal only) 1 x SIM card socket	
Watchdog Timer	WDT 1: 0.5 to 128 sec. with a time resolution of 0.5 sec.	
RTC	Yes ( RTC battery on board)	
LEDs	2 x LED for dual wireless status 2 x LED for DI status 2 x LED for DO status	
Storage	1 x eMMC 8GB flash onboard	
Power Supply	9 to 48 VDC	
Operating Temperature	-40°C to +70°C (-40°F to +158°F)	
Storage Temperature	-45°C to +85°C (-49°F to +185°F)	
Humidity	10% to 95%	
Vibration Endurance	2 Gms @ (10 to 150Hz sine wave; operation)	
Dimensions	55 mm (2.16") (W) x 82 (3.23") mm (D) x 108 (4.25") (H)	
Weight (net/gross)	0.32 kg (0.71 lb)/0.53 kg (1.17 lb)	
Installation	DIN-rail	
Certifications	FCC part 15, Heavy Industrial CE	

## Wireless Specifications

4G module	4G Mini card LTE SIERRA AIRPRIME MC7304 (optional)	Standards: LTE Cat.3 Interface: USB Radio Band/ Frequencies (MHz): 850(5) / 900(8) / 1800(3) / 1900(2) @GSM 850(5) / 900(8) / 1900(2) / 2100(1) @UMTS 800(20) / 900(8) / 1800(3) / 2100(1) / 2600(7) @FDD LTE Region: Global
Wi-Fi module	Wi-Fi Mini card Sparklan WPEQ-160ACN (optional)	Qualcomm Atheros QCA9377-7 Antenna:2xUFL connectors, 1T1R Operating Frequency: 802.11 ac/a/b/g/n ISM Band 2.412 GHz to 2.472 GHz 5.180 MHz to 5.825 MHz Interface: USB Region: Global
3G module	3G Mini card Quectel UC20G (optional)	UMTS:800/ 850/ 900/ 1900/ 2100MHz GSM/EDGE 850/ 900/1800/ 1900MHz Region: Global
4G module	4G Mini card LTE RYR2800 (uBlox R280) (optional)	Standards: LTE Cat.1 Interface: USB Radio Band/ Frequencies (MHz): LTE bands1, 3,5,7,8,28) Region: TW, AU
	4G Mini card LTE RYR2110 (uBlox R211) (optional)	Standards: LTE Cat.1 Interface: USB Radio Band/ Frequencies (MHz): LTE bands1, 3,7,20) Region: EU

## Software Specifications

OS	Linux Kernel 3.14.52 Yocto FIDO 1.8
Protocol Types	ICMP, TCP/IP, UDP, ARP, Telnet, SNMP, HTTP, HTTPS, SSL, SMTP, FTP, TFTP, NTP, DNS, PPP, PPPoE, DHCP, NFS
Software Types	Serial Server Supports TCP Server/TCP Client/UDP/Pair/VC Supports IP filter Supports 32 TCP connections
	Modbus Supports Modbus TCP/Modbus RTU/Modbus ASCII Supports TCP for multiple COM port
Setting Configuration	SNMP Supports V1/V2C/V3 Supports SNMP Private MIB Supports read/write
	http /https Supports SSL Supports import/export Supports FW update
	Remote Manager Remote Log Email SNMP Supports Trap
Alert Function	Yes

## Ordering Information

<b>Standard</b>	
IRU151-FL-DC (P/N: E271151100)	Robust DIN-rail fanless embedded system with i.MX 6UL processor, COM, LAN, DIO (2-in/2-out), 4 AI (16-bit,100 S/s) and 2 PCIe Mini Card Slots (-40°C ~ +70°C)

<b>Optional</b>	
Wireless (3G/GPS or Wi-Fi) module	

## Dimensions

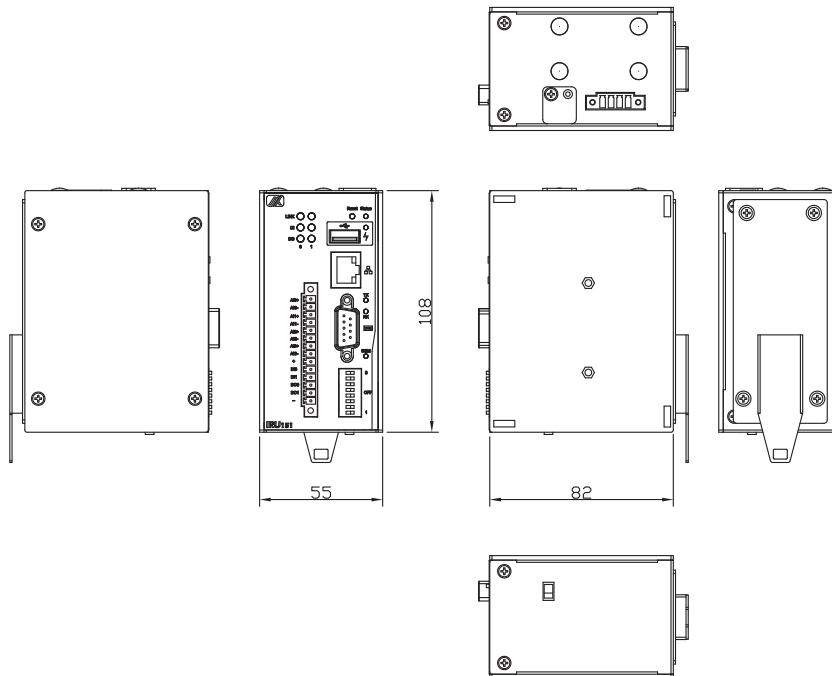

# IRU131

Robust RISC-based DIN-rail Fanless Embedded System with i.MX 6UL Processor, COM, LAN, DIO (2-in/2-out) and 2 PCIe Mini Card Slots

## Features

- RISC-based (i.MX 6UltraLite) processor 528 MHz
- 512MB DDR3 SDRAM onboard
- 8GB eMMC flash onboard
- 2 PCI Express Mini Card slots (Wi-Fi, 3G/4G or LoRa)
- 1 isolated COM port
- 1 isolated DIO (2-in/2-out)
- Power input range of 9V to 48V DC with terminal block
- Embedded Linux operating system (Yocto)
- Wide operating temperature range from -40°C to +70°C
- Supports OPC UA



## Introduction

The IRU131 DIN-rail fanless embedded system utilizes a low power RISC based (i.MX6 UL) processor and is designed to withstand temperatures ranging from -40°C to +70°C for applications in extreme operating environment and industrial automation.

The IRU131 supports one RS-232/422/485 serial ports, one LAN port, two digital input channels, two digital output channels and two wireless sockets. Its vertical DIN-rail form factor makes it easy to install the system in a small cabinet. The ready-to-run IRU131 is specially designed for remote control/ monitoring management applications ideal in a unmanned control room, an industrial machine, an automatic parking lot, a traffic cabinet, just to name a few.

## Specifications

Construction	Extruded aluminum and heavy-duty steel, IP40	
CPU	NXP i.MX 6 UL processor, ARM® Cortex®-A7 @ 528 MHz	
System Memory	1 x DDR3-1600 onboard, 512 MB	
System I/O Outlet	Serial Port	1 x RS-232/422/485 Magnetic isolation protection 2 KV
	LAN	1 x 10/100 Mbps Ethernet Magnetic isolation protection 1.5 KV
	USB	1 x USB 2.0
	DIO	1 x DIO (2-in/2-out) with isolation 2 KV DI: wet/dry DO : wet DI: Input channels: 2 source type Input voltage: 0 to 30 VDC digital input levels for dry contacts: -Logic level 0: close to GND -Logic level 1: open Digital input levels for wet contacts: -Logic level 0: +10V to +24V (DI to COM-) -Logic level 1: +3V max. DO: Output channels: 2, sink type Output current: max. 200 mA per channel On-state voltage: 24 VDC nominal, open collector to 30V Optical isolation protection 2 KV

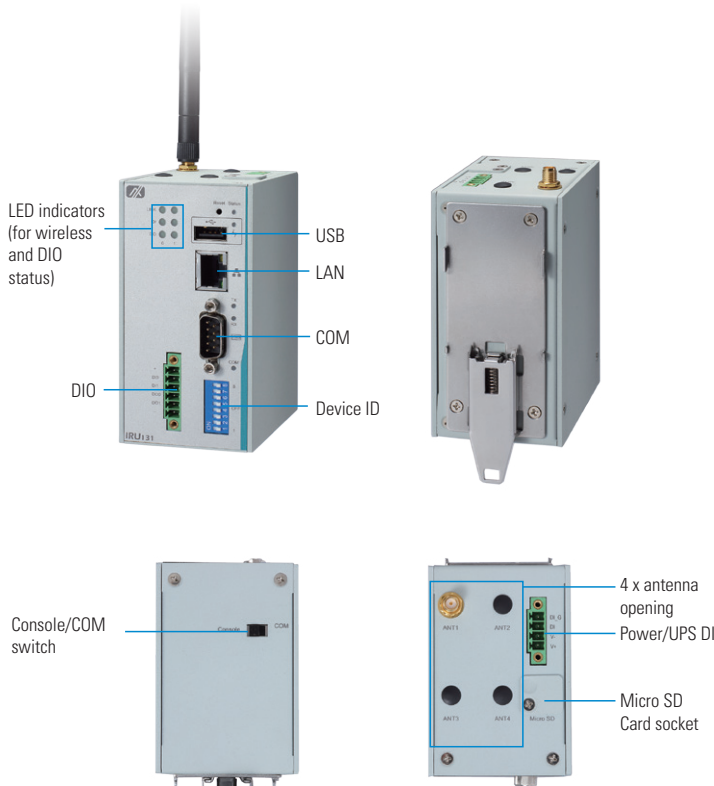

System I/O Outlet	Console Port	Yes For user setting with debug
	EEPROM	1 x EEPROM (2 Kb)
	Device ID	ID setting 0 to 255
	Wireless	2 x PCI Express Mini Card slot (USB signal only) 1 x SIM card socket
Watchdog Timer	0.5 to 128 sec. with a time resolution of 0.5 sec.	
RTC	Yes ( RTC battery on board)	
LEDs	2 x LED for dual wireless status 2 x LED for DI status 2 x LED for DO status	
Storage	1 x eMMC 8GB flash onboard	
Power Supply	9 to 48 VDC	
Operating Temperature	-40°C to +70°C (-40°F to +158°F)	
Storage Temperature	-45°C to +85°C (-49°F to +185°F)	
Humidity	10% to 95%	
Vibration Endurance	2 Gms @ (10 to 150Hz sine wave; operation)	
Dimensions	55 mm (2.16") (W) x 82 (3.23") mm (D) x 108 (4.25") (H)	
Weight (net/gross)	0.3 kg (0.66 lb)/0.50 kg (1.10 lb)	
Installation	DIN-rail	
Certifications	FCC part 15, Heavy Industrial CE	

## Wireless Specifications

4G module	4G Mini card LTE SIERRA AIRPRIME MC7304 (Option)	Standards: LTE Cat.3 Interface: USB Radio Band/ Frequencies (MHz): 850(5) / 900(8) / 1800(3) / 1900(2) @GSM 850(5) / 900(8) / 1900(2) / 2100(1) @UMTS 800(20) / 900(8) / 1800(3) / 2100(1) / 2600(7) @FDD LTE Region: Global
Wi-Fi module	Wi-Fi Mini card Sparklan WPEQ-160ACN (Option)	Qualcomm Atheros QCA9377-7 Antenna:2xUFL connectors, 1T1R Operating Frequency: 802.11 ac/a/b/g/n ISM Band 2.412 GHz to 2.472 GHz 5.180 MHz to 5.825 MHz Interface: USB Region: Global
3G module	3G Mini card Quectel UC20G (Option)	UMTS:800/ 850/ 900/ 1900/ 2100MHz GSM/EDGE 850/ 900/1800/ 1900MHz Region: Global
4G module	4G Mini card LTE RYR2800 (uBlox R280) (Option)	Standards: LTE Cat.1 Interface: USB Radio Band/ Frequencies (MHz): LTE bands1, 3,5,7,8,28 Region: TW, AU
	4G Mini card LTE RYR2110 (uBlox R211) (Option)	Standards: LTE Cat.1 Interface: USB Radio Band/ Frequencies (MHz): LTE bands1, 3,7,20 Region: EU

## Ordering Information

<b>Standard</b>	
IRU131-FL-DC (P/N: E271131100)	Robust DIN-rail fanless embedded system with i.MX 6UL processor, COM, LAN, DIO (2-in/2-out) and 2 PCIe Mini Card slots
<b>Optional</b>	
Wireless (3G/GPS or Wi-Fi) module	

## Packing list

- 1 x CD
- 8 x Screws
- 1 x Din-rail kit
- 1 x 4-pin terminal block for power port
- 1 x 6-pin terminal block for DIO port

## Dimensions

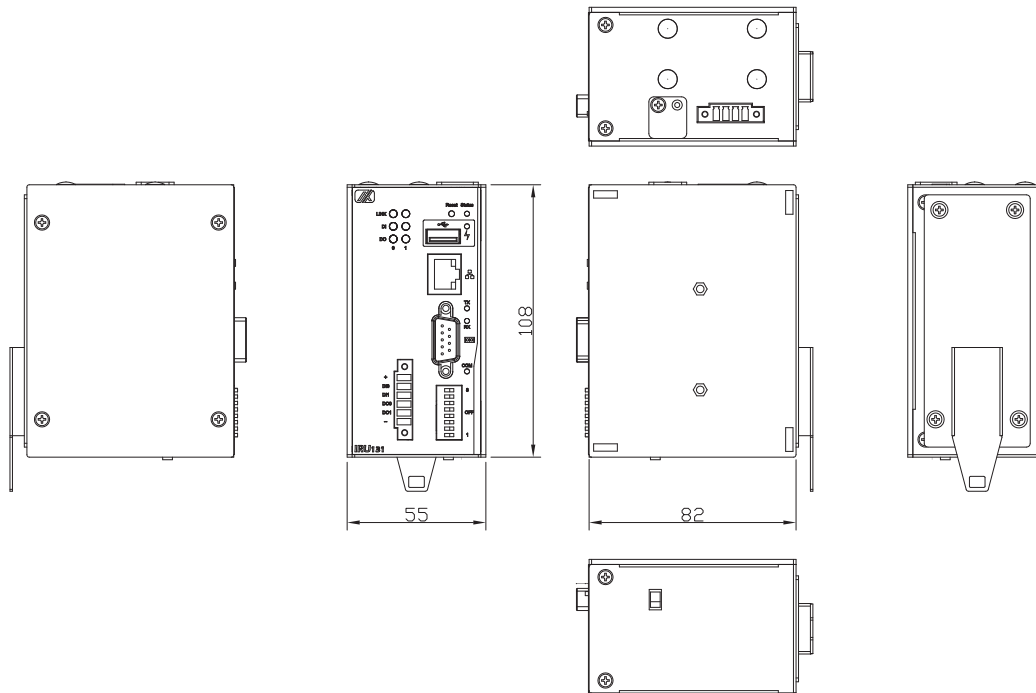



# IFB122

Robust RISC-based DIN-rail Fanless Embedded System with i.MX 6UL Processor, 2 COM, 2 LANs and DIO (2-in/1-out)

## Features

- RISC-based (i.MX 6ULtraLite) processor 528 MHz
- 256MB DDR3 SDRAM onboard
- 4GB eMMC flash onboard
- 1 PCI Express Mini Card slot (Wi-Fi or 3G/4G)
- 2 digital inputs and 1 digital output
- Power input range of 9V to 48V DC with terminal block
- Embedded Linux operating system (Yocto)
- Fanless and compact design
- Wide operating temperature range from -40°C to +70°C



## Introduction

The IFB122 cost-effective DIN-rail fanless embedded system utilizes the low power RISC-based (i.MX6UL) processor and is designed to withstand temperatures ranging from -40°C to +70°C for using in extreme operating environment and industrial automation applications.

The IFB122 features two RS-232/422/485 serial ports, dual LANs, two digital input channels, one digital output channel, LED for user programming and one eMMC onboard 4 GB. Its vertical DIN-rail form factor makes it easy to install the system in a small cabinet. The ready-to-run IFB122 is specially designed for remote control/monitoring management applications like unmanned control room, industrial machine, automatic parking lot, traffic cabinet and more.

## Specifications

Construction	Extruded aluminum and heavy-duty steel, IP40	
CPU	NXP i.MX 6UL processor, ARM® Cortex®-A7 @ 528 MHz	
System Memory	1 x DDR3-1600 onboard, 256 MB	
System I/O Outlet	Serial Port	2 x RS-232/422/485
	LAN	2 x 10/100 Mbps Ethernet Magnetic isolation protection 1.5KV
	Relay	1 x Relay
	USB	1 x USB 2.0
	DIO	1 x DIO (2-in/1-out)
		DI: Wet
		DO: Wet
		DI:
		Digital input levels for wet contacts: -Logic level 0: Close to GND -Logic level 1: +0.7 to +24 V max.
	DO:	Output channels: 1, sink type Output current: max. 200 mA per channel On-state voltage: 24 VDC nominal, open
Console Port	Yes For user setting with debug	
EEPROM	1 x EEPROM (2 Kb)	
Wireless	1 x PCI Express Mini Card slot (USB signal only)	
	1 x SIM card socket	

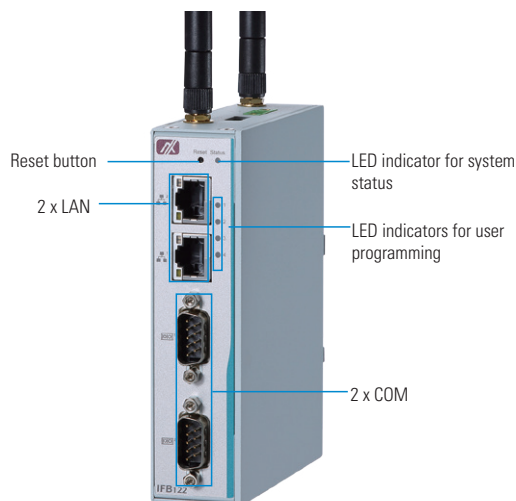

▲ Front view

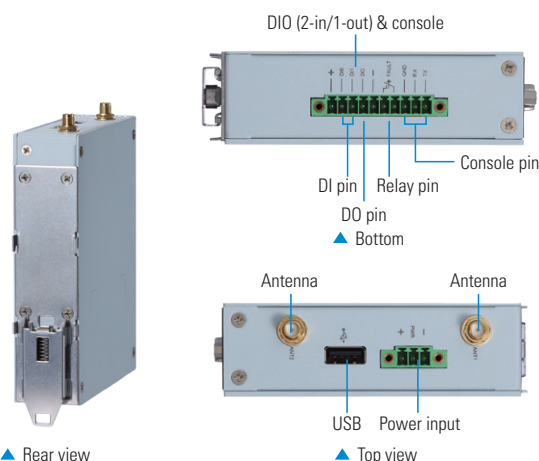

▲ Rear view

▲ Top view

Watchdog Timer	WDT 1: 0.5 to 128 sec. with a time resolution of 0.5 sec.
LEDs	1 x LED for power status
	1 x LED for reset status
	4 x LED (programming by client)
Storage	1 x eMMC 4GB flash onboard
Power Supply	9 to 48 VDC power input range
Operating Temperature	-40°C to +70°C (-40°F to +158°F)
Storage Temperature	-45°C to +85°C (-49°F to +185°F)
Humidity	10% to 95%
Vibration Endurance	5 Gms @ (10 to 150Hz random; operation)
Dimensions	31 mm (1.22") (W) x 100 mm (3.94") (D) x 125 mm (4.92") (H)
Weight (net/gross)	0.3 kg (0.66 lb)/0.44 kg (0.97 lb)
Installation	DIN-rail, wall mount
OS Linux	OS : Yocto 1.8.1 (Fido)
	Kernel: 3.14.52
Certifications	FCC part 15, Heavy Industrial CE

## Ordering Information

### Standard

IFB122-FL-DC (P/N: E26V122100)	Robust DIN-rail fanless embedded system with i.MX 6UL processor, 2 COM, 2 LANs and DIO (2-in/1-out) (-40°C to +70°C)
-----------------------------------	--

### Optional

Wall mount kit Wireless (3G/GPS or Wi-Fi) module
---

## Packing list

- 1 x CD
- 4 x Screws
- 1 x Din-rail kit
- 1 x Console cable
- 1 x 3-pin terminal block for power port
- 1 x 10-pin terminal block for DIO port

\* Specifications and certifications may vary based on different requirements.

## Dimensions

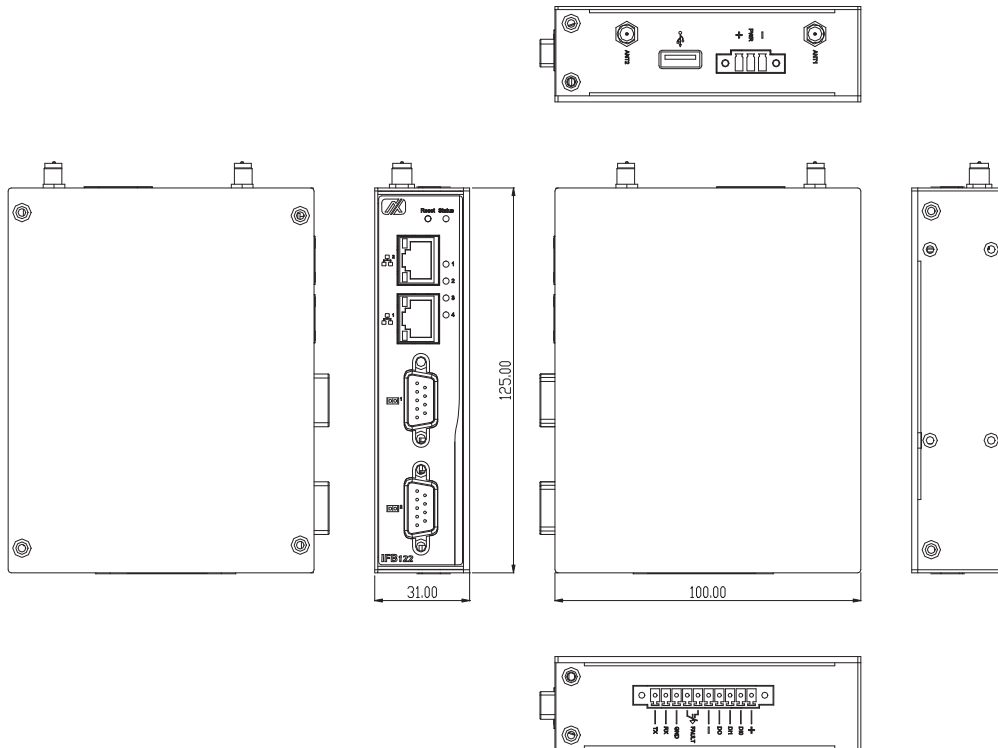

# IFB112

Robust RISC-based DIN-rail Fanless Embedded System with i.MX 6UL Processor, COM, CANbus, 2 LANs and DIO (2-in/1-out)

## Features

- RISC-based (i.MX 6ULtraLite) processor 528 MHz
- 256MB DDR3 SDRAM onboard
- 4GB eMMC flash onboard
- 1 PCI Express Mini Card slot (Wi-Fi or 3G/4G)
- 1 CAN Bus
- 2 digital inputs and 1 digital output
- 9 to 48 VDC wide range power input with terminal block
- Embedded Linux operating system (Yocto)
- Fanless and compact design
- Wide operating temperature range from -40°C to +70°C



## Introduction

The IFB112 cost-effective DIN-rail fanless embedded system utilizes the low power RISC-based (i.MX 6UL) processor and is designed to withstand temperatures ranging from -40°C to +70°C for using in extreme operating environment and industrial automation applications.

The IFB112 features one RS-232/422/485 serial port, dual LAN, one CANbus, two digital input channels, one digital output channel, LED for user programming and one eMMC onboard 4 GB. Its vertical DIN-rail form factor makes it easy to install the system in a small cabinet. The ready-to-run IFB112 is specially designed for remote control/monitoring management applications like unmanned control room, industrial machine, automatic parking lot, traffic cabinet and more.

## Specifications

Construction	Extruded aluminum and heavy-duty steel, IP40																		
CPU	NXP i.MX 6UL processor, ARM® Cortex®-A7, 528 MHz																		
System Memory	1 x DDR3-1600 onboard, 256 MB																		
System I/O Outlet	<table border="1"> <tr> <td>Serial Port</td> <td>1 x RS-232/422/485 (RS-232/422/485 interface select by software)</td> </tr> <tr> <td>CAN Bus</td> <td>1 x CAN 2.0 B (DB9 connector) Meets ISO 11898 standard Software control termination resistor 120 ohm can high speed up to 1Mbit/s for transmit/receive</td> </tr> <tr> <td>LAN</td> <td>2 x 10/100 Mbps Ethernet Magnetic isolation protection 1.5 KV</td> </tr> <tr> <td>Relay</td> <td>1 x Relay</td> </tr> <tr> <td>USB</td> <td>1 x USB 2.0</td> </tr> <tr> <td>DIO</td> <td>1 x DIO (2-in/1-out) DI: wet/dry DO: wet DI: Input channels: 2 source type Input voltage: 0 to 24 VDC digital input levels for dry contacts: -Logic level 0: close to GND -Logic level 1: open Digital input levels for wet contacts : -Logic level 0: Close to GND -Logic level 1: +0.7 to +24 V max. DO: Output channels: 1, sink type Output current: max. 200 mA per channel On-state voltage: 24 VDC nominal, open</td> </tr> <tr> <td>Console Port</td> <td>Yes For user setting with debug</td> </tr> <tr> <td>EEPROM</td> <td>1 x EEPROM (2 Kb)</td> </tr> <tr> <td>Wireless</td> <td>1 x PCI Express Mini Card slot (USB signal only) 1 x SIM card socket</td> </tr> </table>	Serial Port	1 x RS-232/422/485 (RS-232/422/485 interface select by software)	CAN Bus	1 x CAN 2.0 B (DB9 connector) Meets ISO 11898 standard Software control termination resistor 120 ohm can high speed up to 1Mbit/s for transmit/receive	LAN	2 x 10/100 Mbps Ethernet Magnetic isolation protection 1.5 KV	Relay	1 x Relay	USB	1 x USB 2.0	DIO	1 x DIO (2-in/1-out) DI: wet/dry DO: wet DI: Input channels: 2 source type Input voltage: 0 to 24 VDC digital input levels for dry contacts: -Logic level 0: close to GND -Logic level 1: open Digital input levels for wet contacts : -Logic level 0: Close to GND -Logic level 1: +0.7 to +24 V max. DO: Output channels: 1, sink type Output current: max. 200 mA per channel On-state voltage: 24 VDC nominal, open	Console Port	Yes For user setting with debug	EEPROM	1 x EEPROM (2 Kb)	Wireless	1 x PCI Express Mini Card slot (USB signal only) 1 x SIM card socket
Serial Port	1 x RS-232/422/485 (RS-232/422/485 interface select by software)																		
CAN Bus	1 x CAN 2.0 B (DB9 connector) Meets ISO 11898 standard Software control termination resistor 120 ohm can high speed up to 1Mbit/s for transmit/receive																		
LAN	2 x 10/100 Mbps Ethernet Magnetic isolation protection 1.5 KV																		
Relay	1 x Relay																		
USB	1 x USB 2.0																		
DIO	1 x DIO (2-in/1-out) DI: wet/dry DO: wet DI: Input channels: 2 source type Input voltage: 0 to 24 VDC digital input levels for dry contacts: -Logic level 0: close to GND -Logic level 1: open Digital input levels for wet contacts : -Logic level 0: Close to GND -Logic level 1: +0.7 to +24 V max. DO: Output channels: 1, sink type Output current: max. 200 mA per channel On-state voltage: 24 VDC nominal, open																		
Console Port	Yes For user setting with debug																		
EEPROM	1 x EEPROM (2 Kb)																		
Wireless	1 x PCI Express Mini Card slot (USB signal only) 1 x SIM card socket																		

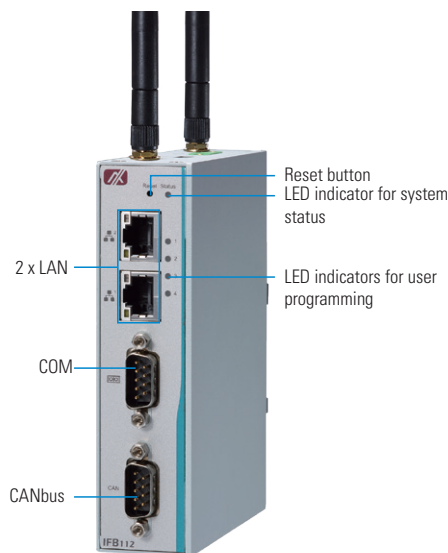

▲ Front view

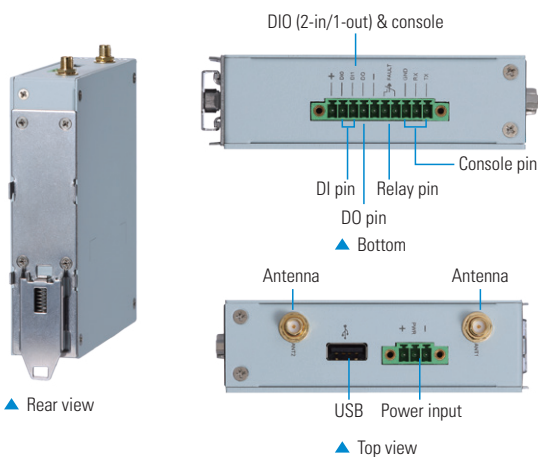

▲ Rear view

▲ Top view

Watchdog Timer	WDT 1: 0.5 to 128 sec. with a time resolution of 0.5 sec.
LEDs	1 x LED for power status 1 x LED for reset status 4 x LED (programming by client)
Storage	1 x eMMC 4GB flash onboard
Power Supply	9 to 48VDC power input range
Operating Temperature	-40°C to +70°C (-40°F to +158°F)
Storage Temperature	-45°C to +85°C (-49°F to +185°F)
Humidity	10% to 95%
Vibration Endurance	3 Gms @ (10 to 150Hz sine wave; operation)
Dimensions	31 mm (1.22") (W) x 100 mm (3.94") (D) x 125 mm (4.92") (H)
Weight (net/gross)	0.3 kg (0.66 lb)/0.44 kg (0.97 lb)
Installation	DIN-rail, wall mount
OS Linux	OS : Yocto 1.8.1 (Fido) Kernel: 3.14.52
Certifications	FCC part 15, Heavy Industrial CE

## Ordering Information

### Standard

IFB112-FL-DC (P/N: E26V112100)	Robust DIN-rail fanless embedded system with i.MX 6UL processor, COM, CANbus, 2 LANs and DIO (2-in/1-out) (-40°C to +70°C)
-----------------------------------	--

### Optional

Wall mount kit Wireless (3G/GPS or Wi-Fi) module
---

## Packing list

- 1 x CD
- 4 x Screws
- 1 x Din-rail kit
- 1 x Console cable
- 1 x 3-pin terminal block for power port
- 1 x 10-pin terminal block for DIO port

\* Specifications and certifications may vary based on different requirements.

## Dimensions

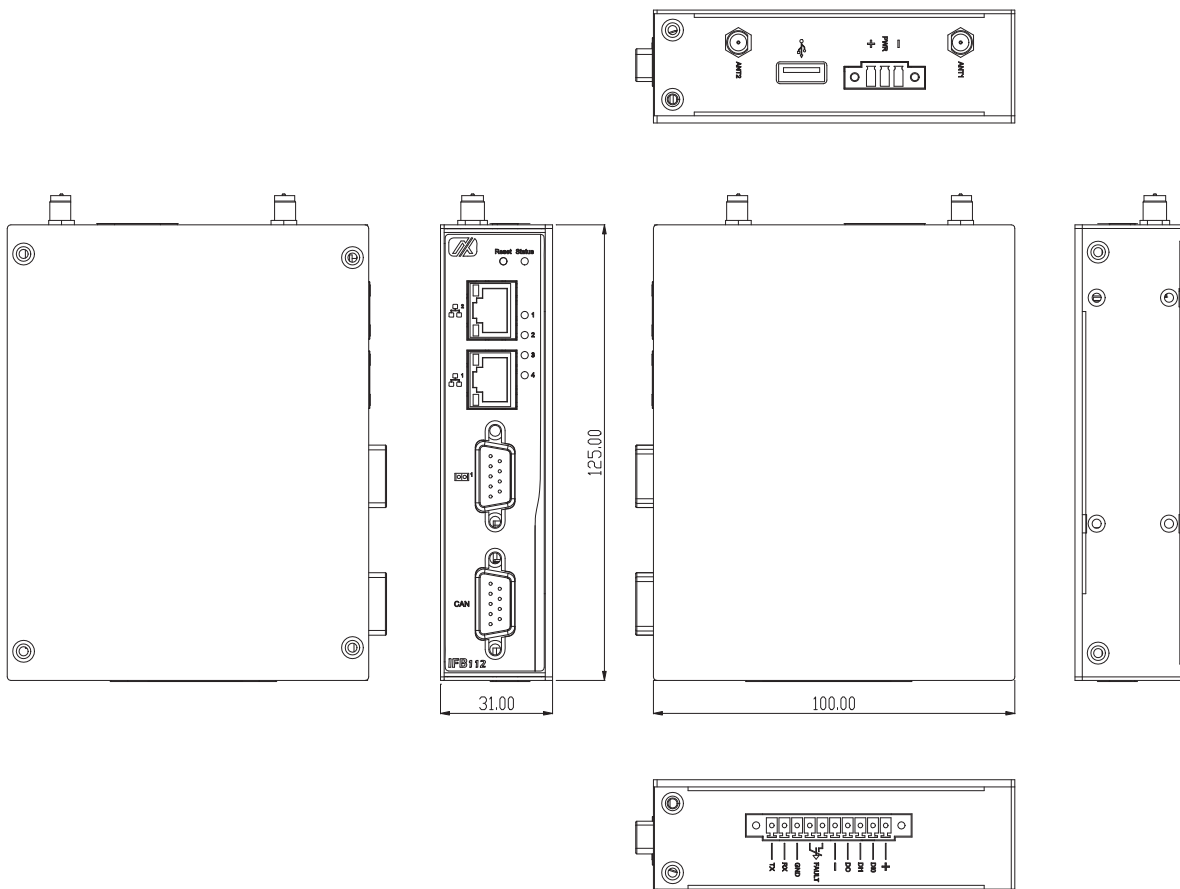

# IFB125

Robust RISC-based DIN-rail Fanless Embedded System with i.MX 6UL Processor, COM, SPI, I<sup>2</sup>C, 2 LANs and DIO (2-in/1-out)

## Features

- RISC-based (i.MX 6ULtraLite) processor 528 MHz
- 256MB DDR3 SDRAM onboard
- 8GB eMMC flash onboard
- 1 SPI, 1 I<sup>2</sup>C
- 1 PCI Express Mini Card slot (Wi-Fi or 3G/4G)
- 2 digital inputs and 1 digital output
- Power input range of 9V to 48V DC with terminal block
- Embedded Linux operating system (Yocto)
- Fanless and compact design
- Wide operating temperature range from -40°C to +70°C



## Introduction

The IFB125 utilizes the low power RISC-based (i.MX6UL) processor and is designed to withstand temperatures ranging from -40°C to +70°C for using in extreme operating environment and industrial automation applications.

The IFB125 features one SPI, one I<sup>2</sup>C, one RS-232/422/485 serial port, dual LANs, two digital input channels, one digital output channel, LED for user programming and one eMMC onboard 8GB. Its vertical form factor makes it easy to install in a small cabinet. The ready-to-run IFB125 is specially designed for remote control/monitoring management applications like unmanned control room, industrial machine, automatic parking lot, traffic cabinet and more.

## Specifications

Construction	Extruded aluminum and heavy-duty steel, IP40	
CPU	NXP i.MX 6UL processor, ARM® Cortex®-A7 @ 528 MHz	
System Memory	1 x DDR3-1600 onboard, 256 MB	
System I/O Outlet	Serial Port	1 x RS-232/422/485
	LAN	2 x 10/100 Mbps Ethernet Magnetic isolation protection 1.5 KV
	SPI	Yes (DB9 connector) (with 3.3V @ 0.5A powered)
	I <sup>2</sup> C	Yes (DB9 connector) (with 3.3V @ 0.5A powered)
	Relay	1 x Relay
	USB	1 x USB 2.0
	DIO	1 x DIO (2-in/1-out) DI: wet/dry Digital input levels for wet contacts: -Logic level 0: Close to GND -Logic level 1: +0.7 to +30 V max. DO: wet Output channels: 1, sink type Output current: max. 200 mA per channel On-state voltage: 24 VDC nominal, open
	Console Port	Yes For user setting with debug
	EEPROM	1 x EEPROM (2 Kb)
	Wireless	1 x PCI Express Mini Card slot (USB signal only) 1 x SIM card socket



▲ Front view



▲ Rear view

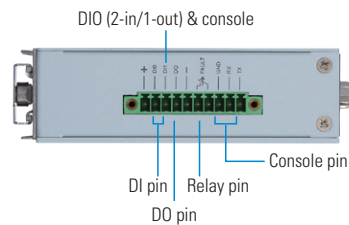

▲ Bottom view

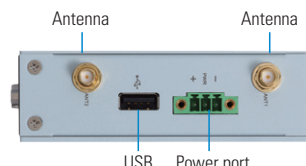

▲ Top view

Watchdog Timer	WDT 1: 0.5 to 128 sec. with a time resolution of 0.5 sec.
LEDs	1 x LED for power status 1 x LED for reset status 4 x LED (programming by client)
Storage	1 x eMMC 8GB flash onboard
Power Supply	9 to 48 VDC power input range
Operating Temperature	-40°C to +70°C (-40°F to +158°F)
Storage Temperature	-45°C to +85°C (-49°F to +185°F)
Humidity	10% to 95%
Vibration Endurance	5 Gms @ (10 to 150Hz random; operation)
Dimensions	31 mm (1.22") (W) x 100 mm (3.94") (D) x 125 mm (4.92") (H)
Weight (net/gross)	0.3 kg (0.66 lb)/0.44 kg (0.97 lb)
Installation	DIN-rail, wall mount
OS Linux	Toolchain/Cross compiler: Yocto Kernel: 3.14.52 (with NXP and Axiomtek hardware modified patch)
Certifications	FCC part 15, Heavy Industrial CE



## Ordering Information

### Standard

IFB125-FL-DC (P/N: E26V125100)	Robust DIN-rail fanless embedded system with i.MX 6UL processor, SPI, I <sup>2</sup> C, COM, 2 LANs and DIO (2-in/1-out) (-40°C to +70°C)
-----------------------------------	---

### Optional

Wall mount kit Wireless (3G/GPS or Wi-Fi) module
---

## Packing list

- 1 x CD
- 4 x Screws
- 1 x Din-rail kit
- 1 x Console cable
- 1 x 3-pin terminal block for power port
- 1 x 10-pin terminal block for DIO port

\* Specifications and certifications may vary based on different requirements.

## Dimensions

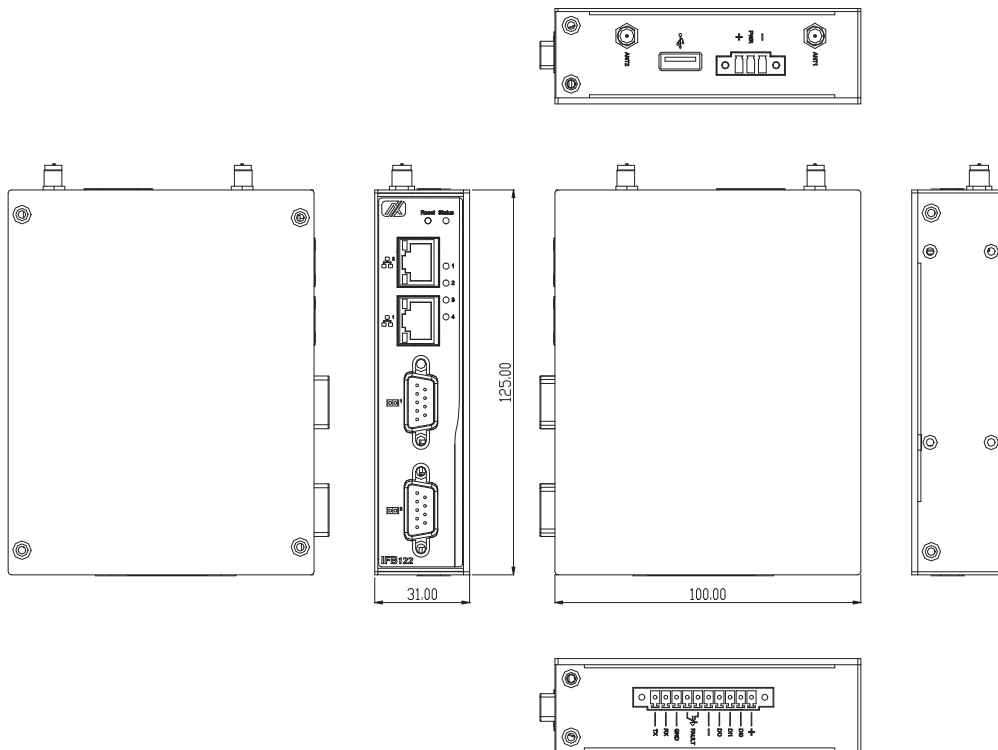



Embedded Systems

Transportation Embedded Systems

DIN-rail Embedded Systems

Digital Signage Players

Embedded MicroBoxes

Industrial Systems

Intelligent Platform Solutions



Industrial Chassis

# Systems and Platforms

# 4

## Digital Signage Players

Axiomtek's advanced digital signage players have been chosen by many industry-leading retail stores and grocery chains, to enhance customers' shopping experience and improve store operation. Axiomtek's open pluggable specification signage solutions are compliant with standard Open Pluggable Specification (OPS) and Open Pluggable Specification Plus (OPS+) architecture. Axiomtek's OPS series delivers greater interoperability, lower total cost, and ease of maintenance without dismantling an entire signage system. The Digital Signage Player series (DSP series) is a powerful tool for the dissemination of information and communication of messages for advertising in retail stores.

Selection Guide		189
<b>OPS+ &amp; OPS Series</b>		
 OPS700-520	Open Pluggable Specification-Plus (OPS+) Digital Signage Player with 8th Gen Intel® Core™ i7/i5/i3 & Celeron® Processor, Intel® Q370 and TPM 2.0	191
 OPS500-520-H	Open Pluggable Specification (OPS) Digital Signage Player with 8th Gen Intel® Core™ i7/i5/i3 & Celeron® Processor, Intel® H310 and TPM 2.0	192
OPS500-501	Open Pluggable Specification (OPS) Digital Signage Player with 6th/7th Gen Intel® Core™ i7/i5/i3 & Celeron® Processor, Intel® Q170 and AMT 11.0	193
OPS500-501-H	Open Pluggable Specification (OPS) Digital Signage Player with 7th/6th Gen Intel® Core™ i7/i5/i3 & Celeron® Processor and Intel® H110	194
OPS300-310	Open Pluggable Specification (OPS) Digital Signage Player with Intel® Celeron® Processor N3350 and TPM 2.0	195
<b>DSP Series</b>		
 DSP300-318	Digital Signage Player with Intel® Pentium® Processor N4200 & Celeron® Processor N3350, DP++/HDMI, 2 GbE LANs and 4 USB	196

# OPS+ & OPS Digital Signage Players

## Selection Guide



Features/Models	OPS700-520	OPS500-520-H	OPS500-501
<b>CPU Level</b>	LGA1151 socket 8th gen Intel® Core™ i7/i5/i3 and Celeron®, 35W TDP	LGA1151 socket 8th gen Intel® Core™ i7/i5/i3 and Celeron®, 35W TDP	7th/6th gen Intel® Core™ i7/i5/i3
<b>Chipset</b>	Intel® Q370	Intel® H310	Intel® Q170
<b>System Memory</b>	2 x 260-pin DDR4-2400 SO-DIMM, up to 32GB	2 x 260-pin DDR4-2400 SO-DIMM, up to 32GB	1 x 260-pin DDR4-2133 SO-DIMM, up to 16GB
<b>Pluggable Engine Box</b>	Yes (OPS+ & OPS compliance)	Yes (OPS compliance)	Yes (OPS compliance)
<b>Intel® AMT</b>	AMT 11.0	N/A	AMT 11.0
<b>TPM</b>	TPM 2.0	TPM 2.0	N/A
<b>I/O</b>	2 x USB 2.0 2 x USB 3.1 Gen2 Type A 1 x RS-232 1 x 10/100/1000 Mbps Ethernet (Intel® i219-LM) 1 x HDMI with 4K/Full HD resolution 1 x Power on/off button 1 x Reset button 1 x 12 VDC power input (adapter available by option)	2 x USB 2.0 2 x USB 3.1 Gen1 Type A 1 x RS-232 1 x 10/100/1000 Mbps Ethernet (Intel® i219-LM) 1 x HDMI with 4K resolution 1 x Power on/off button 1 x Reset button 1 x 12 VDC power input (adapter available by option)	1 x USB 2.0 2 x USB 3.0 1 x RS-232 1 x 10/100/1000 Mbps Ethernet (Intel® i219-LM) 1 x HDMI with 4K resolution 1 x Audio (Mic-in & Line-out) 1 x Power on/off button 1 x Reset button 1 x 12 VDC power input (adapter available by option)
<b>JAETX-25A</b>	1 x DisplayPort with 4K 60Hz supported 1 x HDMI 2.0 with 4K 60Hz supported 2 x USB 2.0 1 x USB 3.0 1 x Audio (Line-out) 1 x UART (TX/RX)	1 x DisplayPort with 4K 60Hz supported 1 x HDMI 2.0 with 4K 60Hz supported 2 x USB 2.0 1 x USB 3.0 1 x Audio (Line-out) 1 x UART (TX/RX)	1 x DisplayPort with 4K 60Hz supported 1 x HDMI 2.0 with 4K 60Hz supported 2 x USB 2.0 1 x USB 3.0 1 x Audio (Line-out) 1 x UART (TX/RX)
<b>HRS FX-18</b>	1 x DisplayPort with 4K 60Hz supported 1 x PCI Express x4	N/A	N/A
<b>Storage</b>	1 x M.2 Key M 2280 SATA/PCIe for storage	1 x M.2 Key M 2280 SATA/PCIe for storage	1 x 2.5" SATA HDD tray 1 x mSATA
<b>Expansion Interface</b>	1 x M.2 Key E 2230 for Wi-Fi	1 x M.2 Key E 2230 for Wi-Fi	1 x full-size PCI Express Mini Card slot (USB + PCIe + SATA)
<b>Power Supply</b>	12 to 19 VDC	12 to 19 VDC	12 to 19 VDC
<b>Dimensions (W x D x H)</b>	200 x 119 x 30 mm (7.87" x 4.68" x 1.18")	200 x 119 x 30 mm (7.87" x 4.68" x 1.18")	200 x 119 x 30 mm (7.87" x 4.68" x 1.18")
<b>Weight (net/gross)</b>	1 kg (2.21 lb)/1.5 kg (3.3 lb)	1 kg (2.21 lb)/1.5 kg (3.3 lb)	1 kg (2.2 lb)/1.5 kg (3.3 lb)
<b>Operating Temperature</b>	0°C to +45°C (+32°F to +113°F) (with airflow 1.2m/s)	0°C to +45°C (+32°F to +113°F) (with airflow 1.2m/s)	0°C to +45°C (+32°F to +113°F)
<b>Certifications</b>	CE, FCC Class A	CE, FCC Class A	CE



Features/Models	OPS500-501-H	OPS300-310	DSP300-318
<b>CPU Level</b>	7th/6th gen Intel® Core™ i7/i5/i3	Intel® Celeron® N3350	Intel® Pentium® N4200 & Celeron® N3350 onboard
<b>Chipset</b>	Intel® H110	SoC Integrated	SoC integrated
<b>System Memory</b>	1 x 260-pin DDR4-2133 SO-DIMM, up to 16GB	1 x 204-pin DDR3L-1600 SO-DIMM, up to 8GB	2 x DDR3L-1600 SO-DIMMs, up to 8GB
<b>Pluggable Engine Box</b>	Yes (OPS compliance)	Yes (OPS compliance)	N/A
<b>Intel® AMT</b>	N/A	N/A	N/A
<b>TPM</b>	N/A	TPM 2.0	N/A
<b>I/O</b>	<ul style="list-style-type: none"> <li>1 x USB 2.0</li> <li>2 x USB 3.0</li> <li>1 x RS-232</li> <li>1 x 10/100/1000 Mbps Ethernet (Intel® i219-LM)</li> <li>1 x HDMI with 4K resolution</li> <li>1 x Audio (Mic-in &amp; Line-out)</li> <li>1 x Power on/off button</li> <li>1 x Reset button</li> <li>1 x 12 VDC power input (adapter available by option)</li> </ul>	<ul style="list-style-type: none"> <li>2 x USB 2.0</li> <li>1 x USB 3.0</li> <li>1 x 10/100/1000 Mbps Ethernet</li> <li>1 x VGA</li> <li>1 x Audio (Mic-in &amp; Line-out)</li> </ul>	<ul style="list-style-type: none"> <li>3 x USB 3.0</li> <li>1 x USB 2.0</li> <li>2 x GbE LAN</li> <li>1 x HDMI 1.4</li> <li>1 x DisplayPort 1.2</li> <li>1 x RS-232 DB9</li> <li>1 x Line-out</li> <li>1 x Mic-in</li> <li>1 x SIM card</li> <li>1 x Power switch</li> <li>1 x Reset switch</li> <li>1 x Remote switch</li> <li>1 x Screw type VDC power input connector</li> <li>4 x Antenna opening</li> </ul>
<b>JAETX-25A</b>	<ul style="list-style-type: none"> <li>1 x DisplayPort with 4K 60Hz supported</li> <li>1 x HDMI 2.0 with 4K 60Hz supported</li> <li>2 x USB 2.0</li> <li>1 x USB 3.0</li> <li>1 x Audio (Line-out)</li> <li>1 x UART (TX/RX)</li> </ul>	<ul style="list-style-type: none"> <li>1 x DisplayPort with 4K 60Hz supported</li> <li>1 x HDMI 2.0 with 4K 60Hz supported</li> <li>2 x USB 2.0</li> <li>1 x USB 3.0</li> <li>1 x Audio (Line-out)</li> <li>1 x UART (TX/RX)</li> </ul>	N/A
<b>HRS FX-18</b>	N/A	N/A	N/A
<b>Storage</b>	<ul style="list-style-type: none"> <li>1 x 2.5" SATA HDD tray</li> <li>1 x mSATA</li> </ul>	<ul style="list-style-type: none"> <li>1 x 2.5" SATA HDD tray</li> <li>1 x mSATA</li> </ul>	<ul style="list-style-type: none"> <li>1 x M.2 Key M 2280</li> <li>1 x eMMC 5.0 64GB (optional)</li> </ul>
<b>Expansion Interface</b>	<ul style="list-style-type: none"> <li>1 x full-size PCI Express Mini Card slot (USB + PCIe + SATA)</li> </ul>	<ul style="list-style-type: none"> <li>1 x full-size PCI Express Mini Card slot (USB + PCIe + SATA)</li> <li>1 x M.2 2230 KEY E for Wi-Fi</li> <li>1 x SIM Slot</li> </ul>	<ul style="list-style-type: none"> <li>1 x M.2 Key E 2230 for Wi-Fi/BT</li> <li>1 x M.2 Key B 3042 for 4G LTE</li> <li>1 x SIM card slot</li> </ul>
<b>Power Supply</b>	12 to 19 VDC	12 to 19 VDC	+12V DC-in
<b>Dimensions (W x D x H)</b>	200 x 119 x 30 mm (7.87" x 4.68" x 1.18")	200 x 119 x 30 mm (7.87" x 4.68" x 1.18")	200 x 137.8 x 20 mm (7.87" x 5.4" x 0.79")
<b>Weight (net/gross)</b>	1 kg (2.2 lb)/1.5 kg (3.3 lb)	1 kg (2.2 lb)/1.5 kg (3.3 lb)	0.90 kg (1.98 lb)/1.57 kg (3.45 lb)
<b>Operating Temperature</b>	0°C to +45°C (+32°F to +113°F)	0°C to +45°C (+32°F to +113°F)	0°C to +50°C (+32°F to +122°F)
<b>Certifications</b>	CE	CE, FCC Class A	CE, FCC class A



# OPS700-520 NEW

Open Pluggable Specification-Plus (OPS+) Digital Signage Player with LGA1151 Socket 8th Gen Intel® Core™ i7/i5/i3 & Celeron® Processor, Intel® Q370 and TPM 2.0

## Features

- Intel® Open Pluggable Specification-Plus (OPS+ compliance)
- 8th gen Intel® Core™ i7/i5/i3 & Celeron® processors (Coffee Lake-S)
- 2 DDR4-2400 SO-DIMM for up to 32GB of memory
- 1 M.2 Key M for storage
- 1 M.2 Key E for Wi-Fi solution
- Supports additional DisplayPort and PCIe x4 through HRS-FX18 connector
- Supports Intel® AMT 11.0 and Intel® Unite
- Supports Trusted Platform Module (TPM) 2.0
- Easy installation and maintenance

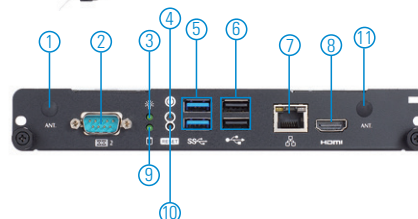

- |                     |                      |                        |
|---------------------|----------------------|------------------------|
| 1. Optional antenna | 6. USB 2.0           | 11. Optional antenna   |
| 2. RS-232           | 7. LAN               | 12. HRS-FX18           |
| 3. Power indicator  | 8. HDMI              | 13. JAE TX-25A         |
| 4. Power button     | 9. Storage indicator | 14. 12 VDC power input |
| 5. USB 3.1 Gen2     | 10. Reset button     |                        |



## Specifications

CPU	LGA1151 socket 8th gen Intel® Core™ i7/i5/i3 & Celeron® processor, 35W TDP
Chipset	Intel® Q370
System Memory	2 x 260-pin DDR4-2400 SO-DIMM, up to 32GB
Storage	1 x M.2 2280 KEY M SATA/PCIe for storage
Watchdog Timer	255 levels, 1 to 255 sec.
TPM	TPM 2.0
Intel® AMT	Intel® AMT 11.0
I/O	2 x USB 3.1 Gen2 Type A 2 x USB 2.0 1 x RS-232 1 x 10/100/1000 Mbps Ethernet (Intel® i219-LM) 1 x HDMI with 4K/Full HD resolution (Default: Full HD) 1 x Power on/off button 1 x Reset button 1 x 12 VDC power input (adapter available by option)
JAE TX-25A	1 x DisplayPort with 4K 60Hz supported 1 x HDMI 2.0 with 4K 60Hz supported 2 x USB 2.0 1 x USB 3.0 1 x Audio (Line-out) 1 x UART (TX/RX)
HRS FX-18	1 x DisplayPort with 4K 60Hz supported 1 x PCI Express x4
Indicator	1 x LED for system power on 1 x LED for storage active
Expansion Interface	1 x M.2 Key E 2230 for Wi-Fi
Dimensions	200 mm (7.87") (W) x 119 mm (4.68") x 30 mm (1.18")
Packing Dimensions	270 mm (10.63") (W) x 197 mm (7.76") x 70 mm (2.76")
Weight (net/gross)	1 kg (2.21lb)/1.5 kg (3.3 lb)
Operating Temperature	0°C to +45°C (+32°F to +113°F) (with airflow 1.2m/s)
Certifications	CE, FCC Class A

## Packing

- 1 x Driver CD
- 1 x Thermal grease
- 2 x M2 x5 screw
- 2 x M4 x6 screw



## Optional OS Installation

Windows® 10 64-bit, Linux

## Ordering Information

### Standard

OPS700-520 OPS+ digital signage player with LGA1151 socket Intel® Core™ i7/i5/i3 & Celeron® processors, Intel® Q370 and TPM 2.0

### Optional

AX93197 OPS+ docking board with 4K @ 60Hz resolution (PCIe x4 and DisplayPort interfaces supported via HRS connector)  
WLAN Kit Wi-Fi module and antenna

\* Specifications and certifications may vary based on different requirements.

## Dimensions

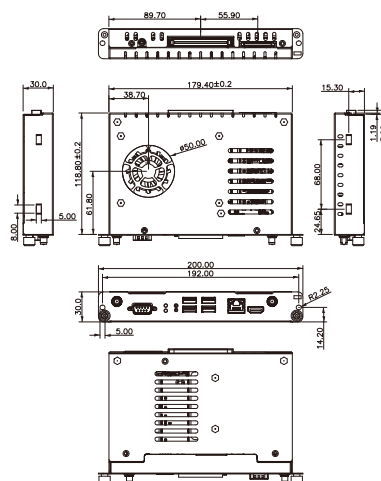



# OPS500-520-H NEW

Open Pluggable Specification (OPS) Digital Signage Player with LGA1151 Socket 8th Gen Intel® Core™ i7/i5/i3 & Celeron® Processor, Intel® H310 and TPM 2.0

## Features

- Intel® Open Pluggable Specification (OPS compliance)
- 8th gen Intel® Core™ i7/i5/i3 & Celeron® processors (Coffee Lake-S)
- 2 DDR4-2400 SO-DIMM for up to 32GB of memory
- 1 M.2 Key M for storage
- 1 M.2 Key E for Wi-Fi solution
- USB 3.1 Gen1 supported
- Supports Trusted Platform Module (TPM) 2.0
- Easy installation and maintenance

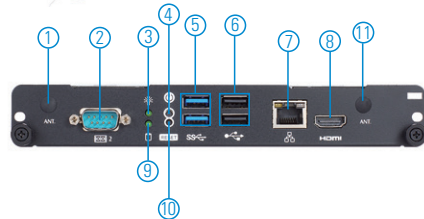

- |                     |                      |                        |
|---------------------|----------------------|------------------------|
| 1. Optional antenna | 6. USB 2.0           | 11. Optional antenna   |
| 2. RS-232           | 7. LAN               | 12. JAE TX-25A         |
| 3. Power indicator  | 8. HDMI 1.4b         | 13. 12 VDC power input |
| 4. Power button     | 9. Storage indicator |                        |
| 5. USB 3.1 Gen1     | 10. Reset button     |                        |



## Specifications

CPU	LGA1151 socket 8th gen Intel® Core™ i7/i5/i3 and Celeron® processor, 35W TDP
Chipset	Intel® H310
System Memory	2 x 260-pin DDR4-2400 SO-DIMM, up to 32GB
Storage	1 x M.2 2280 KEY M SATA/PCIe for storage
Watchdog Timer	255 levels, 1 to 255 sec.
TPM	TPM 2.0
Intel® AMT	N/A
I/O	2 x USB 3.1 Gen1 Type A 2 x USB 2.0 1 x RS-232 1 x 10/100/1000 Mbps Ethernet (Intel® i219-LM) 1 x HDMI 1.4b with 4K resolution 1 x Power on/off button 1 x Reset button 1 x 12 VDC power input (adapter available by option)
JAE TX-25A	1 x DisplayPort with 4K 60Hz supported 1 x HDMI 2.0 with 4K 60Hz supported 2 x USB 2.0 1 x USB 3.0 1 x Audio (Line-out) 1 x UART (TX/RX)
HRS FX-18	N/A
Indicator	1 x LED for system power on 1 x LED for storage active
Expansion Interface	1 x M.2 Key E 2230 for Wi-Fi
Dimensions	200 mm (7.87") (W) x 119 mm (4.68") x 30 mm (1.18")
Packing Dimension	270 mm (10.63") (W) x 197 mm (7.76") x 70 mm (2.76")
Weight (net/gross)	1 kg (2.21 lb)/1.5 kg (3.3 lb)
Operating Temperature	0°C to +45°C (+32°F to +113°F) (with airflow 1.2m/s)
Certifications	CE, FCC Class A

## Packing

- 1 x Driver CD
- 1 x Thermal grease
- 2 x M2 x5 screw
- 2 x M4 x6 screw

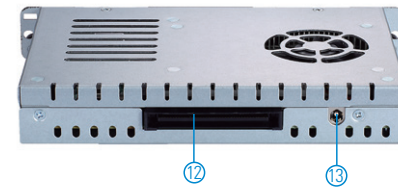

## Optional OS Installation

Windows® 10 64-bit, Linux

## Ordering Information

Standard	
OPS500-520-H	OPS digital signage player with LGA1151 socket Intel® Core™ i7/i5/i3 & Celeron® processor, Intel® H310 and TPM 2.0
Optional	
AX93167	OPS docking board with 4K resolution
AX93190	OPS docking board with 4K @ 60Hz resolution
WLAN Kit	Wi-Fi module and antenna

\* Specifications and certifications may vary based on different requirements.

## Dimensions

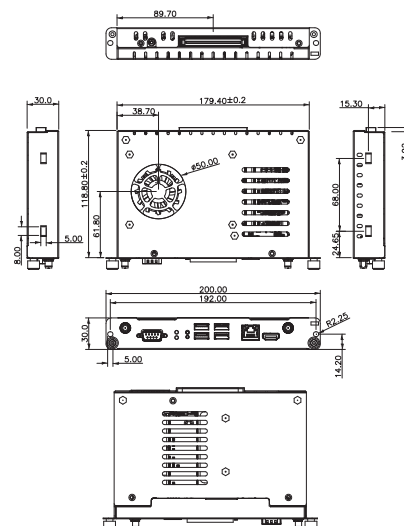

# OPS500-501

Open Pluggable Specification (OPS) Digital Signage Player with LGA1151 Socket 7th/6th Gen Intel® Core™ i7/i5/i3 & Celeron® Processor, Intel® Q170 and Intel® AMT 11.0

## Features

- Intel® Open Pluggable Specification (OPS compliance)
- 7th/6th gen Intel® Core™ i7/i5/i3 & Celeron® processors (Kaby Lake/Skylake)
- 1 DDR4-2133 SO-DIMM for up to 16GB of memory
- 1 PCI Express Mini Card slot
- HDMI for 2nd Ultra HD display with 4K @ 60Hz resolution
- Supports Intel® Active Management Technology (AMT) 11.0
- Easy installation and maintenance



## Specifications

CPU	LGA1151 socket 7th/6th gen Intel® Core™ i7/i5/i3 & Celeron® processor
Chipset	Intel® Q170
System Memory	7th gen Intel® Core™ processor: 1 x 260-pin DDR4-2133/2400 SO-DIMM, up to 16GB 6th gen Intel® Core™ processor: 1 x 260-pin DDR4-2133 SO-DIMM, up to 16GB
Storage	1 x 2.5" SATA HDD tray 1 x mSATA (optional)
Watchdog Timer	255 levels, 1 to 255 sec.
TPM	N/A
Intel® AMT	Intel® AMT 11.0
I/O	2 x USB 3.0 1 x USB 2.0 1 x 10/100/1000 Mbps Ethernet (Intel® i219-LM) 1 x HDMI 1.4b with 4K resolution 1 x RS-232 1 x Power on/off button 1 x Reset button 1 x Audio (Line-out & Mic-in) 1 x 12 VDC power input with adapter
JAE TX-25A	1 x DisplayPort 1 x HDMI 2.0 2 x USB 2.0 1 x USB 3.0 1 x Audio (Line-out) 1 x UART (TX/RX)
HRS FX-18	N/A
Indicator	1 x LED for system power on 1 x LED for HDD active
Expansion Interface	1 x Full-size PCI Express Mini Card slot (USB + PCI Express + SATA signal)
Dimensions	200 mm (7.87") (W) x 119 mm (4.68") x 30 mm (1.18")
Packing Dimensions	270 mm (10.63") (W) x 197 mm (7.76") x 70mm (2.76")
Weight (net/gross)	1 kg (2.21lb)/1.5 kg (3.3 lb)
Operating Temperature	0°C to +45°C (+32°F to +113°F) (with airflow 1.2m/s)
Certifications	CE

## Packing

- 1 x Driver CD
- 1 x Thermal grease
- 2 x M2 x5 screw
- 2 x M4 x5 screw

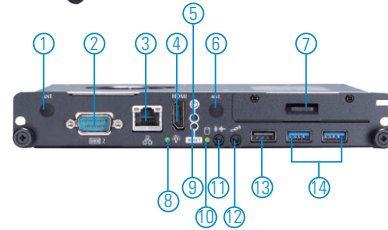

- |                     |                       |                        |
|---------------------|-----------------------|------------------------|
| 1. Optional antenna | 6. Optional antenna   | 11. Audio (Line-out)   |
| 2. RS-232           | 7. 2.5" SATA HDD      | 12. Audio (Mic-in)     |
| 3. LAN              | 8. Power indicator    | 13. USB 2.0            |
| 4. HDMI 1.4b        | 9. Reset button       | 14. USB 3.0            |
| 5. Power button     | 10. Storage indicator | 15. JAE TX-25A         |
|                     |                       | 16. 12 VDC power input |

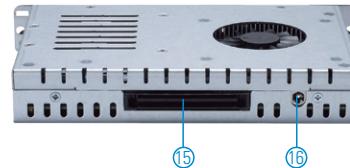

## Optional OS Installation

Windows® 8.1, Windows® 10

## Ordering Information

### Standard

OPS500-501	OPS digital signage player with LGA1151 socket Intel® Core™ i7/i5/i3 & Celeron® processors and Intel® AMT 11.0
------------	--

### Optional

AX93167	OPS docking board with 4K resolution
AX93190	OPS docking board with 4K @ 60Hz resolution
WLAN Kit	Wi-Fi module and antenna

\* Specifications and certifications may vary based on different requirements.

## Dimensions

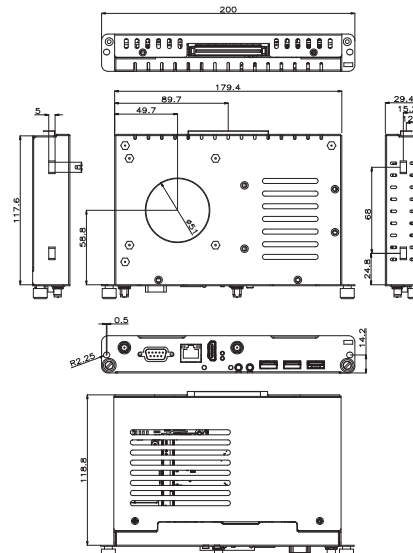

# OPS500-501-H

Open Pluggable Specification (OPS) Digital Signage Player with LGA1151 Socket 7th/6th Gen Intel® Core™ i7/i5/i3 & Celeron® Processor and Intel® H110

## Features

- Intel® Open Pluggable Specification (OPS compliance)
- 7th/6th gen Intel® Core™ i7/i5/i3 & Celeron® processors (Kaby Lake/Skylake)
- DDR4-2133/2400 SO-DIMM for up to 16GB of memory
- 1 PCI Express Mini Card slot
- HDMI for 2nd ultra HD display with 4K @ 60Hz resolution
- Easy installation and maintenance



## Specifications

CPU	LGA1151 socket 7th/6th gen Intel® Core™ and Celeron® processor
Chipset	Intel® H110
System Memory	7th gen Intel® Core™ processor: 1 x 260-pin DDR4-2133/2400 SO-DIMM, up to 16GB 6th gen Intel® Core™ processor: 1 x 260-pin DDR4-2133 SO-DIMM, up to 16GB
Storage	1 x 2.5" SATA HDD tray 1 x mSATA (Option)
Watchdog Timer	255 levels, 1 to 255 sec.
TPM	N/A
Intel® AMT	N/A
I/O	2 x USB 3.0 1 x USB 2.0 1 x 10/100/1000 Mbps Ethernet (Intel® i219-LM) 1 x HDMI 1.4b with 4K resolution 1 x RS-232 1 x Power on/off button 1 x Reset button 1 x Audio (Line-out & Mic-in) 1 x 12 VDC power input with adapter
JAE TX-25A	1 x DisplayPort 1 x HDMI 2.0 2 x USB 2.0 1 x USB 3.0 1 x Audio (Line-out) 1 x UART (TX/RX)
HRS FX-18	N/A
Indicator	1 x LED for system power on 1 x LED for HDD active
Expansion Interface	1 x Full-size PCI Express Mini Card slot (USB + PCI Express + SATA Signal)
Dimensions	200 mm (7.87") (W) x 119 mm (4.68") x 30 mm (1.18")
Packing Dimensions	270 mm (10.63") (W) x 197 mm (7.76") x 70mm (2.76")
Weight (net/gross)	1 kg (2.21 lb)/1.5 kg (3.3 lb)
Operating Temperature	0°C to +45°C (+32°F to +113°F) (with airflow 1.2m/s)
Certifications	CE

## Packing

- 1 x Driver CD
- 1 x Thermal grease
- 2 x M2 x5 screw
- 2 x M4 x6 screw

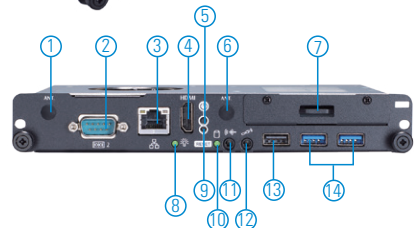

- |                     |                       |                        |
|---------------------|-----------------------|------------------------|
| 1. Optional antenna | 6. Optional antenna   | 11. Audio (Line-out)   |
| 2. RS-232           | 7. 2.5" SATA HDD      | 12. Audio (Mic-in)     |
| 3. LAN              | 8. Power indicator    | 13. USB 2.0            |
| 4. HDMI 1.4b        | 9. Reset button       | 14. USB 3.0            |
| 5. Power button     | 10. Storage indicator | 15. JAE TX-25A         |
|                     |                       | 16. 12 VDC power input |



## Optional OS Installation

Windows® 8.1, Windows® 10

## Ordering Information

### Standard

OPS500-501-H OPS digital signage player with LGA1151 socket Intel® Core™ i7/i5/i3 & Celeron® processor and Intel® H110

### Optional

AX93167 OPS docking board with 4K solution  
AX93190 OPS docking board with 4K @ 60Hz solution  
WLAN Kit Wi-Fi module and antenna

\* Specifications and certifications may vary based on different requirements.

## Dimensions

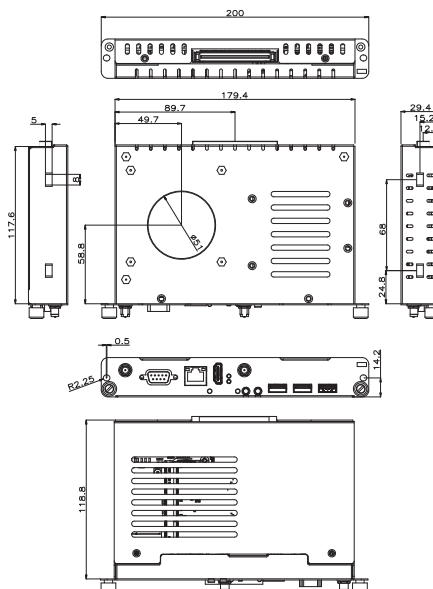

# OPS300-310 NEW

Open Pluggable Specification (OPS) Digital Signage Player with Intel® Celeron® Processor N3350 and TPM 2.0

## Features

- Intel® Open Pluggable Specification (OPS) compliance
- Built-in Intel® Celeron® processor N3350 (fanless)
- DisplayPort & HDMI 2.0 for 4K @ 60Hz resolution
- Supports Trusted Platform Module (TPM) 2.0
- VGA for external display
- Easy installation and maintenance



## Specifications

CPU	Intel® Celeron® processor N3350, up to 2.4 GHz (Apollo Lake)
Chipset	SoC integrated
System Memory	1 x 204-pin DDR3L-1600 SO-DIMM, up to 8GB
Storage	1 x 2.5" SATA HDD tray 1 x mSATA (optional)
BIOS	AMI UEFI BIOS
Watchdog Timer	255 levels, 1 to 255 sec.
TPM	TPM 2.0
Intel® AMT	N/A
I/O	1 x USB 3.0 2 x USB 2.0 1 x 10/100/1000 Mbps Ethernet (RTL8111E) 1 x VGA 1 x Power on/off button 1 x Reset button 1 x Audio (Line-out & Mic-in)
JAE TX-25A	1 x DisplayPort with 4K 60Hz supported 1 x HDMI 2.0 with 4K 60Hz supported 2 x USB 2.0 1 x USB 3.0 1 x Audio (Line-out/Mic-in) 1 x UART (TX/RX)
HRS FX-18	N/A
Indicator	1 x LED for system power on 1 x LED for HDD active
Expansion Interface	1 x Full-size PCI Express Mini Card slot 1 x M.2 2230 KEY E for Wi-Fi Kit 1 x SIM slot
Dimensions	200 mm (7.87") (W) x 119 mm (4.68") x 30 mm (1.18")
Packing Dimensions	270 mm (10.63") (W) x 197 mm (7.76") x 70 mm (2.76")
Weight (net/gross)	1 kg (2.21lb)/1.5 kg (3.31lb)
Operating Temperature	0°C to +45°C (+32°F to +113°F) (with airflow 0.7 m/s)
Certifications	CE, FCC Class A

## Packing

- 1 x Driver CD
- 1 x HDD mylar
- 1 x Thermal pad
- 2 x M3 x4 screw
- 2 x M4 x6 screw

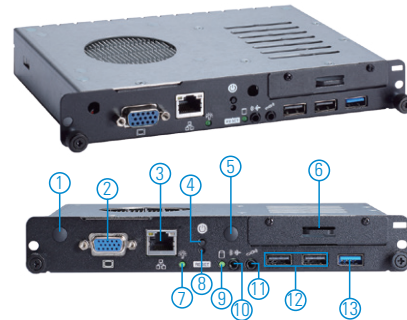

- |                     |                      |                    |
|---------------------|----------------------|--------------------|
| 1. Optional antenna | 6. 2.5" SATA HDD     | 11. Audio (Mic-in) |
| 2. VGA              | 7. Power indicator   | 12. USB 2.0        |
| 3. LAN              | 8. Reset button      | 13. USB 3.0        |
| 4. Power button     | 9. Storage indicator | 14. JAE TX-25A     |
| 5. Optional antenna | 10. Audio (Line-out) |                    |

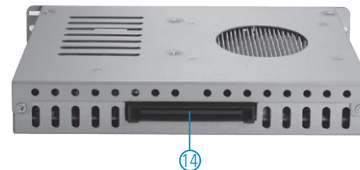

## Optional OS Installation

Windows® 10 64-bit

## Ordering Information

### Standard

OPS300-310 OPS digital signage player with Intel® Celeron® processor N3350 and TPM 2.0

### Optional

AX93167 OPS docking board with 4K resolution  
 AX93190 OPS docking board with 4K @ 60Hz resolutions  
 WLAN/WWAN Kit Wi-Fi module and antenna

\* Specifications and certifications may vary based on different requirements.

## Dimensions

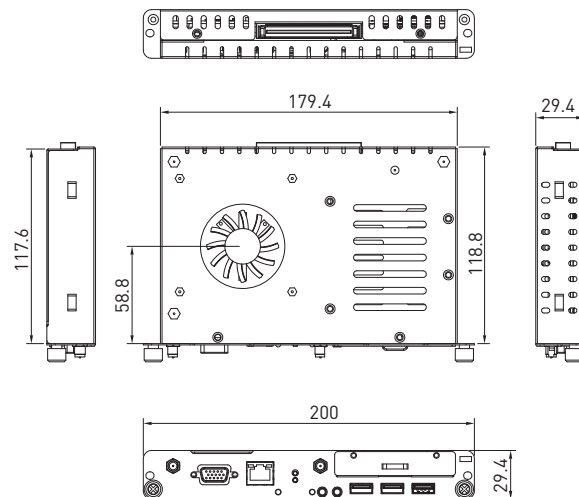

# DSP300-318 NEW

Digital Signage Player with Intel® Pentium® Processor N4200 & Celeron® Processor N3350, DisplayPort++, HDMI, 2 GbE LANs and 4 USB

## Features

- Fanless operation with low power consumption
- 2 DDR3L-1600 SO-DIMM for up to 8GB of memory
- 1 HDMI 1.4 and 1 DisplayPort 1.2
- 4 USB, 2 GbE LAN
- 1 M.2 Key E 2230 for Wi-Fi/BT
- 1 M.2 Key B 3042 for 4G LTE
- 1 M.2 Key M 2280 for storage



1 x M.2 2280 KEY M  
1 x M.2 3042 KEY B (4G/LTE option)  
1 x M.2 2230 KEY E (Wi-Fi/BT option)

Intel® Pentium® N4200 quad-core & Celeron® N3350 dual-core (Apollo Lake)



▲ Rear view

- |                        |                 |                         |
|------------------------|-----------------|-------------------------|
| 1. Remote power switch | 6. Line-out     | 11.1 x RS-232           |
| 2. Power button        | 7. Mic-in       | 12. 1 x HDMI 1.4        |
| 3. Reset Button        | 8. 2 x LANs     | 13. 1 x DisplayPort 1.2 |
| 4. SIM                 | 9. 1 x USB 3.0  | 14. DC-in               |
| 5. 2 x USB 3.0         | 10. 1 x USB 2.0 | 15. 2 x DDR3L SO-DIMM   |

## Specifications

CPU	Intel® Pentium® processor N4200 2.5GHz & Celeron® processor N3350 2.4GHz onboard
Chipset	SoC integrated
System Memory	2 x DDR3L-1600 SO-DIMM, up to 8GB
Storage	1 x M.2 2280 KEY M 1 x eMMC 5.0 64GB (optional)
Watchdog Timer	255 levels, 1 to 255 sec./min.
I/O	3 x USB 3.0 1 x USB 2.0 2 x 10/100/1000 Mbps Ethernet 1 x HDMI 1.4 1 x DisplayPort 1.2 1 x RS-232 DB9 1 x Line-out 1 x Mic-in 1 x SIM card 1 x Power switch 1 x Reset switch 1 x Remote switch 1 x Screw type VDC power input connector 4 x Antenna opening
Expansion Interface	1 x M.2 2230 KEY E for Wi-Fi/BT 1 x M.2 3042 KEY B for 4G LTE 1 x SIM card slot
Battery Lithium	Lithium 3 V/220 mAH
System Indicator	1 x White LED for HDD active
Power Input	+12V DC-in
Dimensions	200 mm (7.87") (W) x 137.8 mm (5.4") (D) x 20 mm (0.79") (H)
Weight (net/gross)	0.90 kg (1.98 lb)/1.57 kg (3.45 lb)
Vibration Endurance	3 Grms with M.2 storage (5 to 500Hz, X, Y, Z directions)
Certifications	CE, FCC class A
Operating Temperature	0°C to +50°C (32°F to 122°F)
Humidity	10% to 90% relative humidity, non-condensing
EOS support	Win 10 IoT, Linux

## Packing List

- 1 x Quick installation guide
- 1 x Adapter 12V 36W
- 1 x Power cord
- 1 x Wall mount bracket
- 4 x Foot pad

## Ordering Information

Standard	
DSP300-318-N4200-US, 4GB RAM, 64GB M.2	Digital signage player with Intel® Pentium® N4200 2.5GHz, DP++, HDMI, 2 GbE LANs, 4 USB, 12V/36W power adapter and US power cord, 4GB RAM, 64GB M.2
DSP300-318-N4200-EU, 4GB RAM, 64GB M.2	Digital signage player with Intel® Pentium® N4200 2.5GHz, DP++, HDMI, 2 GbE LANs, 4 USB, 12V/36W power adapter and EU power cord, 4GB RAM, 64GB M.2
DSP300-318-N3350-US, 4GB RAM, 64GB M.2	Digital signage player with Intel® Celeron® N3350 2.4GHz, DP++, HDMI, 2 GbE LANs, 4 USB, 12V/36W power adapter and US power cord, 4GB RAM, 64GB M.2
DSP300-318-N3350-EU, 4GB RAM, 64GB M.2	Digital signage player with Intel® Celeron® N3350 2.4GHz, DP++, HDMI, 2 GbE LANs, 4 USB, 12V/36W power adapter and EU power cord, 4GB RAM, 64GB M.2





Embedded Systems

Transportation Embedded Systems

DIN-rail Embedded Systems

Digital Signage Players

Embedded MicroBoxes

Industrial Systems

Intelligent Platform Solutions

Industrial Chassis

# Systems and Platforms



# 5



## Embedded MicroBoxes

Axiomtek's MicroBoxes are perfect for industrial automation, medical, POS, gaming, digital signage and security market applications. With specific I/Os and pre-installed embedded operating systems, executing embedded solutions has become easier, and time to market reduced.

Selection Guide		199
AX60630	Embedded MicroBox for Low Power Mini-ITX SBC	200
AX60650	Embedded MicroBox for Mini-ITX SBC	201
ECM100	Embedded Computing Machine Chassis for Mini-ITX SBC	202
ECM300	Embedded Computing Machine Chassis with 2 Expansion Slots for Mini-ITX SBC	203

# Embedded MicroBoxes

## Selection Guide

Model (W x D x H)	Accessory Specifications			SBC Selections	
	Drive Bay	Expansion Slot	Power Supply	3.5" Capa	Mini ITX
 <b>AX60630</b> 259.5 x 186 x 58.5 mm	1 x 2.5"	N/A	12V, 60W		MAN0300 MAN0842
 <b>AX60650</b> 202 x 320 x 73 mm	1 x 2.5"	N/A	PSU 150W		MAN0500 MAN0881 MAN0882 MAN0873
 <b>ECM100</b> 265 x 250 x 71.5 mm	2 x 2.5"	N/A	ATX 250W Input: AC 115 to 230V Output: +3.3V @ 10A, +5V @ 10A, +12V @ 8.5A, -12V @ 0.4A, +5VSB @ 1A, +5VSB @ 2.5A		MAN0500
 <b>ECM300</b> 335 x 250 x 88 mm	1 x 3.5"	2 x PCIe or 1 x PCIe x16	ATX 250W Input: AC 115 to 230V Output: +3.3V @ 10A, +5V @ 10A, +12V @ 8.5A, -12V @ 0.4A, +5VSB @ 1A, +5VSB @ 2.5A		MAN0500

# AX60630

Embedded MicroBox for Low Power Mini-ITX SBC

## Features

- Designed for low power Mini-ITX SBC
- One 2.5" HDD supported
- Wall mount
- Slim design with 2 system fans



▲ Front view

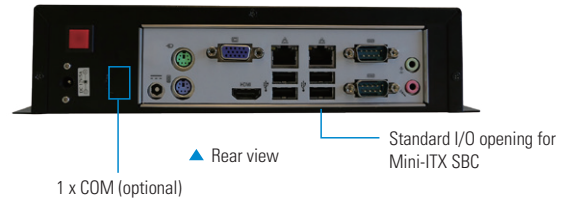

▲ Rear view

1 x COM (optional)

Standard I/O opening for Mini-ITX SBC

## Specifications

Standard Color	Black	
Construction	Heavy-duty cold-rolled steel	
Indicator	1 x blue LED for system power-on	
Panel I/O	Front	N/A
	Rear	1 x Standard Mini-ITX I/O bracket space 1 x Power button 1 x COM (optional)
Expansion Interface	N/A	
Storage	1 x 2.5" HDD	
Cooling	2 x 40 x 40 mm system fan	
Power Input	12V, 60W	
Dimensions	202 mm (7.95") (D) x 320 mm (12.59") (W) x 73 mm (2.87") (H)	
Environment	EMI pre-scan meets EN55022 Class A	

## Applications

Embedded PC controller  
Compact industrial PC  
POS  
Digital Signage

## Ordering Information

<b>Standard</b>	
AX60630	Embedded MicroBox for low power Mini-ITX SBC
<b>SBC Options</b>	
MAN0842/MAN0300	

## Dimensions

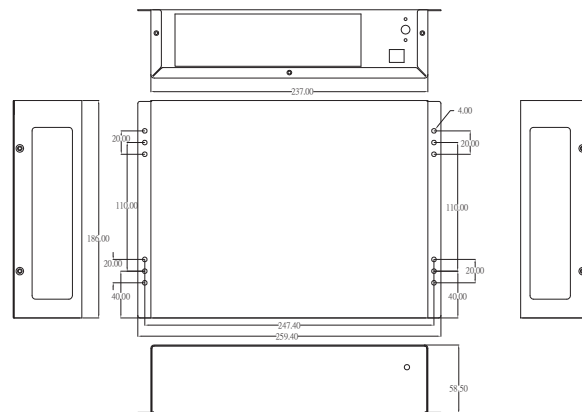

# AX60650

Embedded MicroBox for Mini-ITX SBC

## Features

- Designed for Mini-ITX SBC
- One 2.5" HDD supported
- 3 COM supported (optional)
- Cost-effective design



▲ Front view

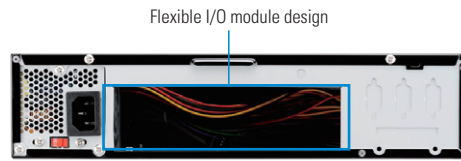

▲ Rear view

## Specifications

Standard Color	Black	
Construction	Heavy-duty cold-rolled steel	
Indicator	1 x HDD activity 1 x Power status	
Panel I/O	Front	1 x Power button
	Rear	1 x standard Mini-ITX I/O bracket space 3 x COM (optional)
Expansion Interface	N/A	
Storage	1 x 2.5" HDD	
Cooling	N/A	
Power Input	150W PSU	
Dimensions	202 mm (7.95") (D) x 320 mm (12.59") (W) x 73 mm (2.87") (H)	
Environment	EMI pre-scan meets EN 55022 Class A	

## Ordering Information

### Standard

AX60650 Embedded MicroBox for Mini-ITX SBC

### SBC Options

MAN0500/MAN0881/MAN0882/MAN0873

## Dimensions

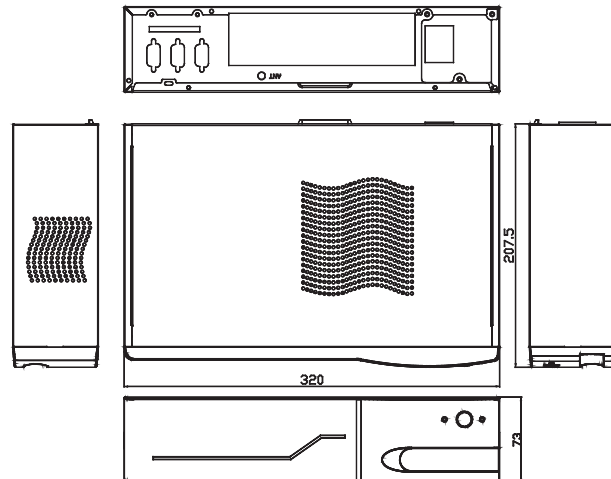

## Applications

Embedded PC controller  
Compact industrial PC  
POS  
Digital signage

## Packing List

1 x AC power cord

# ECM100

Embedded Chassis for Mini-ITX SBC

## Features

- Designed for Mini-ITX SBC
- Two 2.5" HDD drive bays
- Optional 250W AC-in power supply
- Wall mount kit supported
- Slim design with 1 system fan
- Easy and quick customization

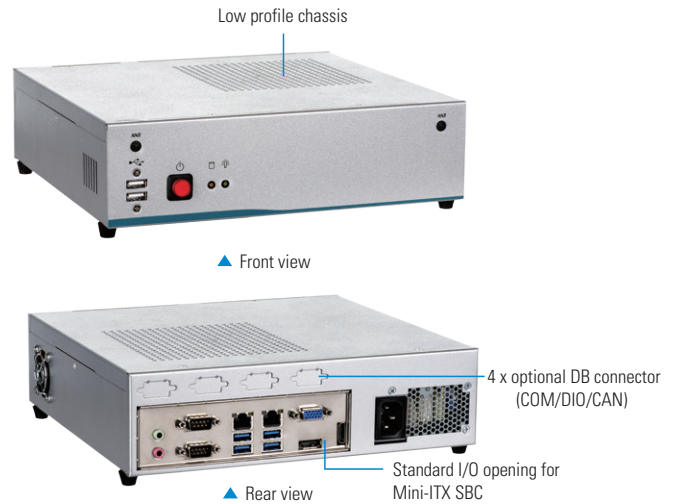

## Specifications

Standard Color	Silver
Construction	Heavy-duty cold-rolled steel
Indicator	1 x green LED for system power-on 1 x orange LED for HDD active
Panel I/O	Front <ul style="list-style-type: none"> <li>1 x ATX power button</li> <li>2 x USB 2.0</li> <li>2 x SMA type connector opening for Antenna</li> </ul>
	Rear <ul style="list-style-type: none"> <li>1 x standard Mini-ITX I/O bracket space</li> <li>4 x optional DB connector (COM/DIO/CAN)</li> </ul>
Expansion Interface	N/A
Storage	2 x 2.5" HDD (max. 9.5 mm height)
Cooling	40 x 40 mm system fan
Power Input	ATX 250W
	Input: AC 115 to 230V Output: +3.3V @ 10A, +5V @ 10A, +12V @ 8.5A, -12V @ 0.4A, +5VSB @ 1A
Dimensions	265 mm (10.43") (W) x 250 mm (9.84") (D) x 71.5 mm (2.81")
Environment	EMI pre-scan meets EN 55022 Class A

## Applications

Factory automation  
Embedded controller  
Machine vision system  
IIoT gateway  
Compact industrial PC

## Ordering Information

Standard	
ECM100	Embedded chassis for Mini-ITX SBC

### SBC Options

MAN0500-H110 (P/N: E38M500100)	
MAN0500-Q170 (P/N: E38M500106)	

### Optional

881721000A0E	Wall mount kit
50986624010E	250W AC power supply
82723001030E	250W FAN bracket kit
594K6402110E	RS-232 cable
Power cord	

\*Specifications and certifications may vary according to various options.

## Dimensions

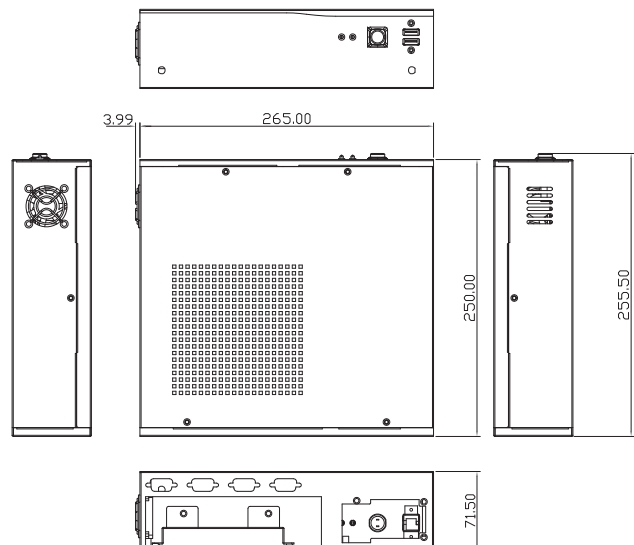

# ECM300

Embedded Chassis with Expansion Slots for Mini-ITX SBC

## Features

- Designed for Mini-ITX SBC with expansion slots
- One 3.5" or 2.5" HDD drive bay
- Two PCIe or one PCIe x16 expansion slots supported
- Slim design with 1 system fan
- 250W power supply supported
- Easy and quick customization

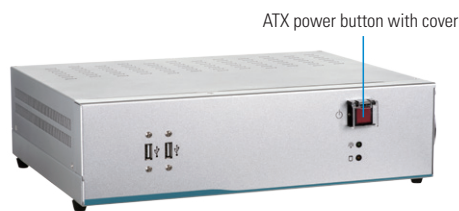

▲ Front view

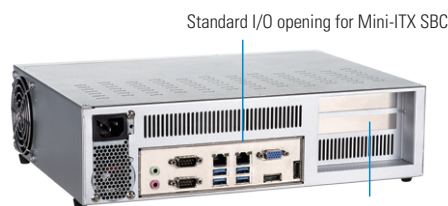

▲ Rear view

## Specifications

Standard Color	Silver
Construction	Heavy-duty cold-rolled steel
Indicator	1 x green LED for system power-on 1 x orange LED for HDD active
Panel I/O	Front 1 x ATX power button with cover 2 x USB 2.0 Antenna Rear 1 x standard Mini-ITX I/O bracket space
Expansion Interface	1 x PCIe x16 or 2 x PCIe x8
Storage	1 x 3.5" HDD or 1 x 2.5" HDD (max. 9.5 mm height)
Cooling	80 x 80 mm system fan
Power Input	ATX 250W Input: AC 115 to 230V Output: +3.3V @ 10A, +5V @ 10A, +12V @ 8.5A, -12V @ 0.4A, +5VSB @ 1A
Dimensions	335 mm (13.2") (W) x 250 mm (9.8") (D) x 88 mm (3.5") (H)
Environment	EMI pre-scan meets EN 55022 Class A

## Applications

Factory automation  
Embedded controller  
Machine vision system  
Compact industrial PC

## Ordering Information

Standard	
ECM300	Embedded chassis with expansion slots for Mini-ITX SBC
SBC Options	
MAN0500-H110 (P/N: E38M500100)	Support 1 x PCIe x16
MAN0500-Q170 (P/N: E38M500106)	Support 1 x PCIe x16 or 2 x PCIe x8
Optional	
5A009672300E	AX96723 (1 x PCIe x16 riser card)
83961471000E	AX96147 (2 x PCIe x8 riser card)
881723000A0E	Wall mount kit
50986624010E	250W AC power supply
82723001030E	250W FAN bracket kit
Power cord	

\*Specifications and certifications may vary according to various options.

## Dimensions

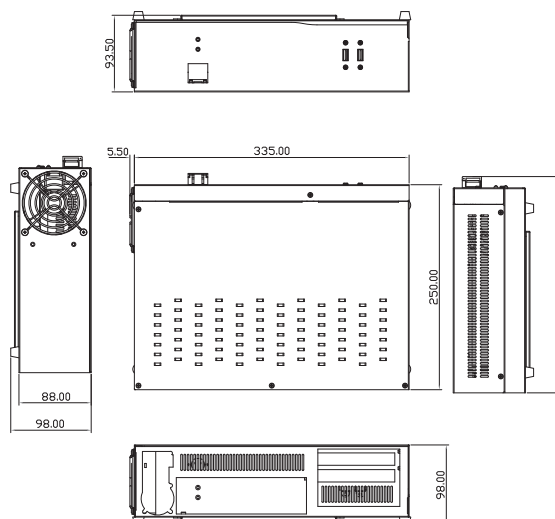



# 6

## Industrial Systems

Axiomtek has a full range of fanless, intelligent platform that are suitable for different environments and applications. These industrial PCs offer powerful computing performance, scalability, high storage capacity, reliability, and solid design. Axiomtek IPC products are in compliance with the relevant EU legislation (CE Marking). They offer popular interfaces and rich I/O options.

Selection Guide		205
IPC962-511-FL	2-slot Fanless Industrial System with LGA1151 Socket 7th/6th Gen Intel® Core™ i7/i5/i3 & Celeron® Processor (up to 3.4 GHz), Intel® H110, Front-access I/O, PCIe and PCI Slots	207
 IPC962-512-FL	2-slot Fanless Industrial System with LGA1151 Socket 7th/6th Gen Intel® Core™ i7/i5/i3 & Celeron® Processor (up to 3.4 GHz), Intel® Q170, Front-access I/O, PCIe and PCI Slots	209
IPC964-512-FL	4-slot Fanless Industrial System with LGA1151 Socket 7th/6th Gen Intel® Core™ i7/i5/i3 & Celeron® Processor (up to 3.4 GHz), Intel® Q170, Front-access I/O, PCIe and PCI Slots	211
IPC922-215-FL	2-slot Fanless Industrial System with Intel® Celeron® Processor J1900 (up to 2.42 GHz), Front-access I/O, PCIe and PCI Slots	213
IPC932-230-FL	2-slot Fanless Industrial System with 4th Gen Intel® Core™ i7/i5/i3 & Celeron® Processor (up to 3.3 GHz), Intel® Q87, Front-access I/O, PCIe and PCI Slots	215
 IPC310-501	Wall Mount Industrial System with LGA1151 Socket 7th/6th Gen Intel® Core™ Processor, Intel® H110, USB 3.0, SATA 3.0, Dual LANs, VGA/DisplayPort/HDMI and mSATA	217

## Systems and Platforms

# Industrial Systems

## Selection Guide



Features/Models	IPC962-511-FL	IPC962-512-FL	IPC964-512-FL
<b>CPU Level</b>	7th/6th gen Intel® Core™ i7/i5/i3 & Celeron® up to 35W	7th/6th gen Intel® Core™ i7/i5/i3 & Celeron® up to 35W (Kaby Lake/Skylake)	7th/6th gen Intel® Core™ i7/i5/i3 & Celeron® up to 35W
<b>System Memory</b>	2 x DDR4-2133 un-buffered SO-DIMM, up to 32GB	2 x DDR4-2133/2400 un-buffered SO-DIMM, up to 32GB	2 x DDR4-2133 un-buffered SO-DIMM, up to 32GB
<b>Chipset</b>	Intel® H110	Intel® Q170	Intel® Q170
<b>Vision I/O</b>	N/A	N/A	N/A
<b>Expansion I/O Module</b>	4 x RS-232/422/485 module (default RS-232) or 2 x RS-232/422/485 with isolated 1.5KVDC module and 8-in/8-out isolated DIO or 4 x RS-232/422/485 isolated 2KVDC module (default RS-232)	4 x RS-232/422/485 (default RS-232) or 2 x RS-232/422/485 with isolated 1.5KVDC module and 8-in/8-out isolated DIO or 4 x RS-232/422/485 isolated 2KVDC module (default RS-232) or 1 x 10/100/1000 Mbps Ethernet, 2 RS-232/422/485 and 2 USB 3.0 module	4 x RS-232/422/485 module (default RS-232) or 2 x RS-232/422/485 with isolated 1.5KVDC module and 4-in/4-out isolated DIO or 4 x RS-232/422/485 isolated 2KVDC module (default RS-232) or 1 x 10/100/1000 Mbps Ethernet, 2 RS-232/422/485 and 2 USB 3.0 module
<b>Display</b>	1 x HDMI 1 x VGA	1 x HDMI 1 x VGA	1 x HDMI 1 x VGA
<b>Audio</b>	Yes	Yes	Yes
<b>PS/2</b>	N/A	N/A	N/A
<b>Ethernet</b>	2 x 10/100/1000 Mbps Ethernet	2 x 10/100/1000 Mbps Ethernet	2 x 10/100/1000 Mbps Ethernet
<b>USB</b>	4 x USB 3.0	4 x USB 3.0	4 x USB 3.0
<b>Expansion Interface</b>	1 PCIe x16 + 1 PCIe x4 or 1 PCIe x16 + 1 PCI or 2 PCI 1 PCI Express Mini Card slot (USB 2.0 interface)	1 PCIe x16 + 1 PCIe x4 or 1 PCIe x16 + 1 PCI or 2 PCI 1 PCI Express Mini Card slot (PCIe and USB 2.0 interface)	1 PCIe x16 + 3 PCIe x4 or 1 PCIe x16 + 1 PCIe x4 + 2 PCI 1 PCI Express Mini Card slot (PCIe and USB 2.0 interface)
<b>Storage</b>	2 x 2.5" swappable HDD	2 x 2.5" swappable HDD	2 x 2.5" swappable HDD
<b>Watchdog Timer</b>	255 levels, 1 to 255 sec.	255 levels, 1 to 255 sec.	255 levels, 1 to 255 sec.
<b>Power Input</b>	24 VDC (uMin=19V/uMax=30V)	24 VDC (uMin=19V/uMax=30V)	24 VDC (uMin=19V/uMax=30V)
<b>Operating Temperature</b>	-10°C to +60°C (+14°F to +140°F) with 6th gen CPU -10°C to +50°C (+14°F to +122°F) with 7th CPU	-10°C to +60°C (+14°F to +140°F) with 6th gen CPU -10°C to +50°C (+14°F to +122°F) with 7th CPU	-10°C to +60°C (+14°F to +140°F) with 6th gen CPU -10°C to +50°C (+14°F to +122°F) with 7th CPU
<b>Wall Mount</b>	Yes	Yes	Yes
<b>Dimensions (W x D x H)</b>	147.5 x 192 x 230 mm (5.80" x 7.54" x 9.04")	147.5 x 192 x 230 mm (5.80" x 7.54" x 9.04")	188.1 x 192 x 230 mm (7.39" x 7.54" x 9.04")
<b>Weight (net/gross)</b>	4.382 kg (9.66 lb)/5.346 kg (11.80 lb)	4.382 kg (9.66 lb)/5.346 kg (11.80 lb)	4.8 Kg (10.56 lb)/5.9 Kg (12.98 lb)
<b>Certifications</b>	CE/FCC	CE/FCC	CE/FCC
<b>EOS Support</b>	6th gen platform: Win 7 32/64-bit & Win 10 64-bit 7th gen platform: Win 10 64-bit	6th gen platform: Win 7 32/64-bit & Win 10 64-bit 7th gen platform: Win 10 64-bit	6th gen platform: Win 7 32/64-bit & Win 10 64-bit 7th gen platform: Win 10 64-bit



Features/Models	IPC922-215-FL	IPC932-230-FL	IPC310-501
<b>CPU Level</b>	Intel® Celeron® J1900	4th gen Intel® Core™ i7/i5/i3 & Celeron®	LGA1151 socket 7th/6th gen Intel® Core™ i7/i5/i3, Pentium® & Celeron®
<b>System Memory</b>	1 x 204-pin DDR3L-1333 SO-DIMM, up to 8GB	2 x 204-pin DDR3-1333/1600 SO-DIMM, up to 16GB	2 x 288-pin DDR4-2133/1866 DIMM, up to 32GB
<b>Chipset</b>	SoC integrated	Intel® Q87	Intel® H110
<b>Serial</b>	RS-232/422/485	2 x RS-232/422/485 2 x RS-232	2 x RS-232/422/485 4 x RS-232
<b>Display</b>	1 x VGA	1 x DVI-I	1 x HDMI 1 x VGA
<b>Audio</b>	N/A	Yes	Yes
<b>PS/2</b>	N/A	Yes	Yes
<b>Ethernet</b>	2 x 10/100/1000 Mbps Ethernet	2 x 10/100/1000 Mbps Ethernet	2 x 10/100/1000 Mbps Ethernet
<b>USB</b>	4 x USB 2.0	4 x USB 2.0 2 x USB 3.0	4 x USB 3.0 2 x USB 2.0
<b>Expansion Interface</b>	2 PCI or 1 PCI & 1 PCIe x4	1 PCIe x1 & 1 PCIe x4 or 1 PCI & 1 PCIe x4	1 x PCIe x16 2 x PCIe x4 slot (only support x1 signal) 4 x PCI 1 x PCI Express Mini Card 1 x SIM slot
<b>Storage</b>	1 x 2.5" HDD 1 x CFast™	2 x 2.5" HDD 1 x CFast™	3 x SATA-600 1 x mSATA
<b>Watchdog Timer</b>	255 levels, 1 to 255 sec.	255 levels, 1 to 255 sec.	255 levels, 1 to 255 sec.
<b>Power Supply</b>	120 W ATX 18 to 28 VDC	150 W ATX 10 to 30 VDC	350W ATX
<b>Operating Temperature</b>	-10°C to +50°C (+14°F to +122°F) (with W.T. HDD)	-10°C to +55°C (+14°F to +140°F) (with W.T. SSD or Cfast)	0°C to +40°C (+32°F to +104°F)
<b>Wall Mount</b>	Yes	Yes	Yes
<b>Dimensions (W x D x H)</b>	118 x 248 x 185 mm (4.6" x 9.8" x 7.3")	164 x 245.6 x 185 mm (6.45" x 9.65" x 7.27")	196 x 407.4 x 330 mm (7.72" x 16.04" x 12.99")
<b>Weight (net/gross)</b>	4.22 kg (9.28 lb)/5.3 kg (11.68 lb)	6.2 kg (13.67 lb)/7.2 kg (15.87 lb)	12 kg (26.49 lb)/13.3 kg (29.36 lb)
<b>Certifications</b>	CE	CE	CE compliance
<b>EOS Support</b>	WES7	WES7	6th gen platform: Win 7 32/64-bit & Win 10 64-bit 7th gen platform: Win 10 64-bit



# IPC962-511-FL

2-slot Fanless Industrial System with LGA1151 Socket 7th/6th Gen Intel® Core™ i7/i5/i3 & Celeron® Processor, Intel® H110, Front-access I/O, PCIe and PCI Slots

## Features

- LGA1151 socket 7th/6th gen Intel® Core™ i7/i5/i3 & Celeron® processor, up to 35W (codename: Kaby Lake/Skylake)
- Intel® H110 chipset
- Supports 2 expansion slots
- Power input: 24 VDC (uMin=19V/uMax=30V)
- Compact & front I/O design
- -10°C to +60°C operating temperature range
- Supports 2 swappable 2.5" HDD
- Supports WLAN module & antenna (optional)
- Supports TPM 2.0 (optional)



▲ Rear view

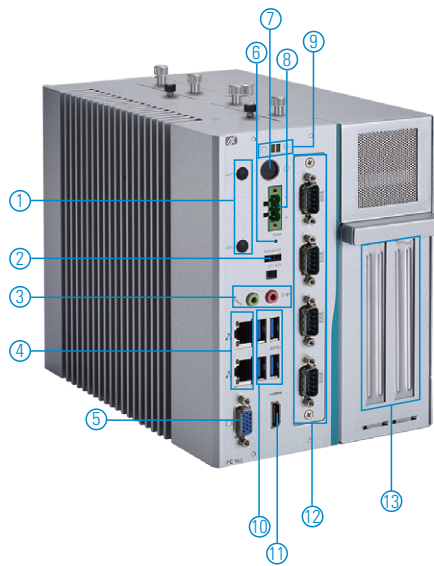

- |                        |                     |  |
|------------------------|---------------------|--|
| 1. 2 x Antenna opening | 6. Reset switch     | 12. (1) AX93511: 4 x RS-232/422/485 (default RS-232)   |
| 2. Remote switch       | 7. Power switch     | (2) AX93512: 2 x RS-232/422/485 with isolated 1.5KVDC & 8-in/8-out DIO with isolated 1.5KVDC |
| 3. Mic-in & Line-out   | 8. Terminal block   | (3) AX93516: 4 x RS-232/422/485 with isolated 2KVDC module                                   |
| 4. 2 x LAN             | 9. HDD & Power LEDs | 13. (1) AX96205: 1 PCIe x16 + 1 PCIe x4  |
| 5. VGA                 | 10. 4 x USB 3.0     | (2) AX96206: 1 PCIe x16 + 1 PCI  |
|                        | 11. HDMI            | (3) AX96207: 2 PCI   |

## Specifications

Standard Color	Silver	
Construction	Aluminum extrusion heavy-duty cold-rolled steel, IP40 (w/o fan module)	
Processor System	CPU Level	7th/6th gen Intel® Core™ i7/i5/i3 & Celeron® processor, up to 35W (codename: Kaby Lake/Skylake)
	Max. Speed	3.4 GHz
	Chipset	Intel® H110
	System Memory	2 x DDR4-2133/2400 un-buffered SO-DIMM, up to 32GB
System I/O	1 x Switch for power on/off (ATX)	
	1 x Remote switch	
	1 x Reset switch	
	1 x 3-pin terminal block	
	1 x AT/ATX selectable switch	
	2 x 10/100/1000 Mbps Ethernet (Intel® i211-AT)	
	4 x USB 3.0	
	1 x HDMI	
	1 x VGA	
	1 x Audio (Mic-in/Line-out)	
Expansion I/O Module	AX93511: 4 x RS-232/422/485 (default RS-232)	
	AX93512: 2 x RS-232/422/485 with isolated 1.5KVDC & 8-in/8-out DIO with isolated 1.5KVDC	
	AX93516: 4 x RS-232/422/485 with isolated 2KVDC module	
TPM	TPM 2.0 (optional)	

Expansion Interface	AX96205: 1 x PCIe x16 Gen3 + 1 x PCIe x4 AX96206: 1 x PCIe x16 Gen3 + 1 x PCI AX96207: 2 x PCI 1 x Full-size PCI Express Mini Card slot with USB interface
Storage	2 x 2.5" swappable HDD (15 mm height)
System Indicators	1 x Power LED 1 x HDD LED
Power Input	Type: ATX/AT Input: 24 VDC (uMin=19V/uMax=30V)
Operating Temperature	-10°C to +60°C (+14°F to +140°F) with 6th gen Intel® Core™ and W.T. HDD/SSD
	-10°C to +50°C (+14°F to +122°F) with 7th gen Intel® Core™ and W.T. HDD/SSD
Storage Temperature	-20°C to +80°C (-4°F to +176°F)
Humidity	10% to 90%, non-condensing
Dimensions	147.5 mm (5.80") (W) x 192 mm (7.54") (H) x 230 mm (9.04") (D)
Weight (net/gross)	4.382 kg (9.66 lb)/5.346 kg (11.80 lb)
Certifications	CE compliance

\* All specifications and photos are subject to change without notice.

## Ordering Information

System	
IPC962-511-DC-FL (P/N: E26G962A00)	2-slot fanless industrial system with LGA1151 socket 7th/6th gen Intel® Core™ i7/i5/i3 & Celeron® processor, Intel® H110 chipset, and front-access I/O
IPC962-511-DC-ECM-FL (P/N: E26G962A02)	2-slot fanless EtherCAT master controller with 7th/6th gen Intel® Core™ i7/i5/i3 processor and Intel® H110, and front-access I/O

I/O Module & Riser Card	
AX93511 (P/N: 8816G962020E)	4 x RS-232/422/485 module (default RS-232)
AX93512	4 x RS-232/422/485 with isolated 1.5KV
AX93516 (P/N: 8816G962030E)	2 x RS-232/422/485 with isolated 1.5KVDC & 8-in/8-out with DIO isolated 2KVDC
726G9620610E	IPC962-511 blank I/O cover
AX96205 (P/N: 83962051000E)	1 x PCIe x16 + 1 PCIe x4 expansion kit
AX96206 (P/N: 83962061000E)	1 x PCIe x16 + 1 PCI expansion kit
AX96207 (P/N: 83962071000E)	2 x PCI expansion kit

Optional	
2.5" SATA HDD/SSD	
DDR4-2133/2400 un-buffered SO-DIMM, up to 32GB	
826G9620010E / 8816G9620A0E	IPC962-511-FL fan module kit
826G9620020E / 8816G9621A0E	Wall mount bracket kit
50906D24000E	Adaptor 24V/120W, wire only
AX92320 (P/N: E392320100)	4-port PCI Express GbE PoE communication card
AX92351 (P/N: E392351100)	32-in/32-out isolated 1.5KV DIO module

## Dimensions

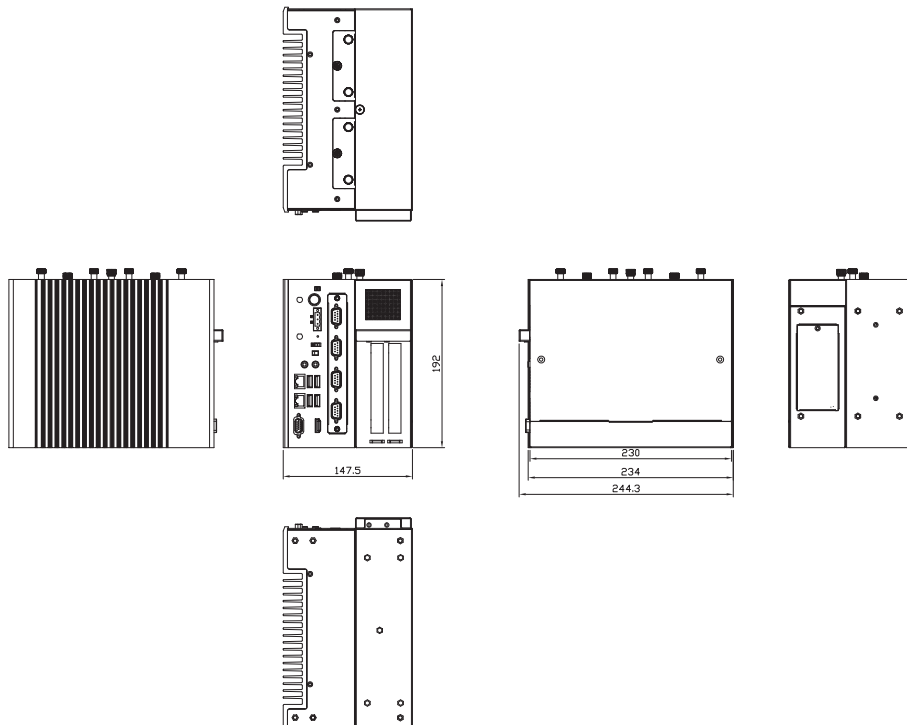

## Power Protection

DC Version
OVP (over voltage protection)
SCP (short circuit protection)
OCP (over current protection)

## Packing List

- 1 x IPC962-511-FL unit
- 1 x Driver CD
- 1 x Screw pack
- 4 x Foot pad
- 1 x CPU grease
- 1 x Terminal block
- 1 x Remote power switch cable
- 1 x Holder bracket

# IPC962-512-FL NEW

2-slot Fanless Industrial System with LGA1151 Socket 7th/6th Gen Intel® Core™ i7/i5/i3 & Celeron® Processor, Intel® Q170, Front-access I/O, PCIe and PCI Slots

## Features

- LGA1151 Socket 7th/6th gen Intel® Core™ i7/i5/i3 & Celeron® processor, up to 35W
- Intel® Q170 chipset
- Supports 2 expansion slots
- Power input: 24 VDC (uMin=19V/uMax=30V)
- Compact & front I/O design
- -10°C to +60°C operating temperature range
- Supports 2 swappable 2.5" HDD & RAID 0,1
- Supports WLAN module & antenna (optional)
- Supports TPM 2.0 (optional)



▲ Rear view



- |                        |                     |   |
|------------------------|---------------------|---|
| 1. 2 x Antenna opening | 6. Reset switch     | 12. (1) AX93511: 4 x RS-232/422/485 module (default RS-232)   |
| 2. Remote switch       | 7. Power switch     | (2) AX93512: 2 x RS-232/422/485 with isolated 1.5KVDC & 8-in/8-out with isolated 1.5KVDC DIO module |
| 3. Mic-in & Line-out   | 8. Terminal block   | (3) AX93516: 4 x RS-232/422/485 with isolated 2KVDC module  |
| 4. 2 x LAN             | 9. HDD & Power LEDs | (4) AX93519: 1 x 10/100/1000 Mbps Ethernet 2 x RS-232/422/485 2 x USB 3.0 module                    |
| 5. VGA                 | 10. 4 x USB 3.0     | 13. (1) AX96205: 1 PCIe x16 + 1 PCIe x4   |
|                        | 11. HDMI            | (2) AX96206: 1 PCIe x16 + 1 PCI   |
|                        |                     | (3) AX96207: 2 PCI  |

## Specifications

Standard Color	Silver	
Construction	Aluminum extrusion heavy-duty cold-rolled steel, IP40 (w/o fan module)	
Processor System	CPU Level	7th/6th gen Intel® Core™ i7/i5/i3 & Celeron® processor, up to 35W (codename: Kaby Lake/Skylake)
	Max. Speed	3.4 GHz
	Chipset	Intel® Q170
System Memory	2 x DDR4-2133/2400 un-buffered SO-DIMM, up to 32GB	
System I/O	1 x Switch for power on/off (ATX)	
	1 x Remote switch	
	1 x Reset switch	
	1 x 3-pin terminal block	
	1 x AT/ATX selectable switch	
	2 x 10/100/1000 Mbps Ethernet (Intel® i211-AT)	
	4 x USB 3.0	
	1 x HDMI	
	1 x VGA	
	1 x Audio (Mic-in/Line-out)	
Extension System IO Module	AX93511: 4 x RS-232/422/485 (default RS-232)	
	AX93512: 2 x RS-232/422/485 with isolated 1.5KVDC & 8-in/8-out DIO with isolated 1.5KVDC	
	AX93516: 4 x RS-232/422/485 with isolated 2KVDC module	
	AX93519: 1 x 10/100/1000 Mbps Ethernet, 2 x RS-232/422/485 and 2 x USB 3.0 module	
TPM	TPM 2.0 (optional)	

Expansion Interface	AX96205: 1 x PCIe x16 Gen3 + 1 x PCIe x4 Gen3 AX96206: 1 x PCIe x16 Gen3 + 1 x PCI AX96207: 2 x PCI 1 x Full-size PCI Express Mini Card slot with USB & PCIe interface
Storage	2 x 2.5" swappable HDD (15 mm height), support RAID 0,1
System Indicators	1 x Power LED 1 x HDD LED
Power Input	Type: ATX/AT Input: 24 VDC (uMin=19V/uMax=30V)
Operating Temperature	-10°C to +60°C (+14°F to +140°F) with 6th gen. Intel® Core™ and W.T. HDD/SSD -10°C to +50°C (+14°F to +122°F) with 7th gen. Intel® Core™ and W.T. HDD/SSD
Storage Temperature	-20°C to +80°C (-4°F to +176°F)
Humidity	10% to 90%, non-condensing
Dimensions	147.5 mm (5.80") (W) x 192 mm (7.54") (H) x 230 mm (9.04") (D)
Weight (net/gross)	4.382 kg (9.66 lb)/5.346 kg (11.80 lb)
Certifications	CE compliance

\* All specifications and photos are subject to change without notice.



## Ordering Information

System	
IPC962-512-DC-FL (P/N: E26G962A01)	2-slot fanless industrial system with 7th/6th gen Intel® Core™ i7/i5/i3 processor and Intel® Q170, and front-access I/O
IPC962-512-DC-ECM-FL (P/N: E26G962A03)	2-slot fanless EtherCAT master controller with 7th/6th gen Intel® Core™ i7/i5/i3 processor and Intel® Q170, and front-access I/O

I/O Module & Riser Card	
AX93511 (P/N: 8816G962020E)	4 x RS-232/422/485 IO module (default RS-232)
AX93512	2 x RS-232/422/485 with isolated 1.5KVDC & 8-in/8-out with isolated 1.5KVDC DIO module
AX93516 (P/N: 8816G962030E)	4 x RS-232/422/485 with isolated 2KVDC module
AX93519	1 x 10/100/1000 Mbps Ethernet, 2 x RS-232/422/485 and 2 x USB 3.0 module
726G9620610E	IPC962-511 blank I/O cover
AX96205 (P/N: 83962051000E)	1 x PCIe x16 + 1 PCIe x4 expansion kit
AX96206 (P/N: 83962061000E)	1 x PCIe x16 + 1 PCI expansion kit
AX96206 (P/N: 83962061000E)	2 x PCI expansion kit

Optional	
2.5" SATA HDD/SSD	
DDR4-2133/2400 un-buffered SO-DIMM, up to 32GB	
826G9620010E / 8816G9620A0E	IPC962-512-FL fan module kit
826G9620020E / 8816G9621A0E	Wall mount bracket kit
50906D24000E	Adaptor 24V/120W, wire only
AX92320 (P/N: E392320100)	4-port PCI Express GbE PoE communication card
AX92351 (P/N: E392351100)	32-in/32-out isolated 1.5KV DIO module

## Dimensions

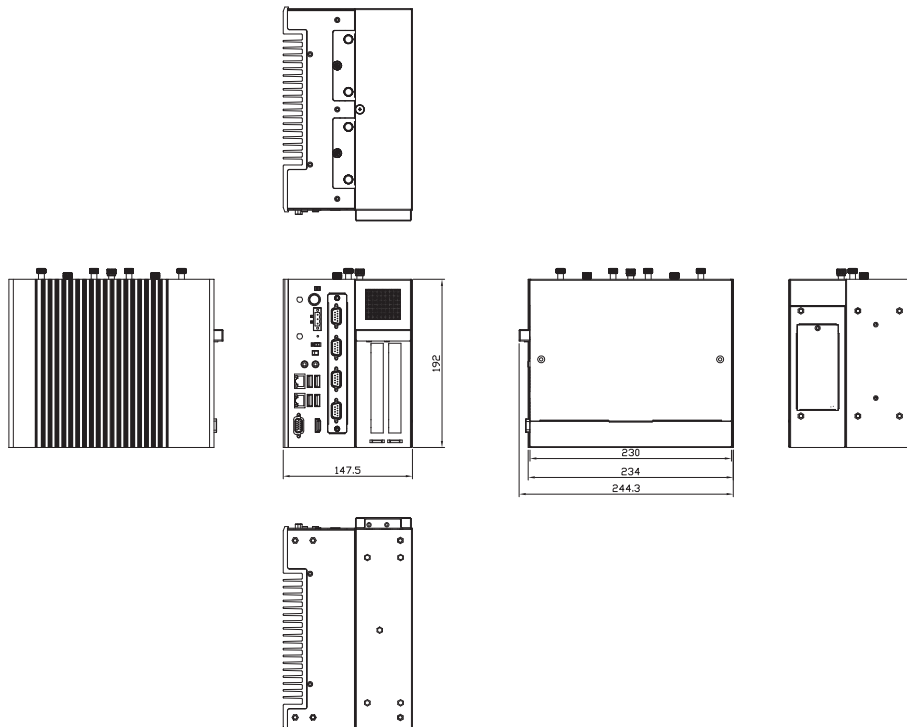

## Power Protection

DC Version
OVP (over voltage protection)
SCP (short circuit protection)
OCP (over current protection)

## Packing List

- 1 x IPC962-512-FL unit
- 1 x Driver CD
- 1 x Screw pack
- 4 x Foot pad
- 1 x CPU grease
- 1 x Terminal block
- 1 x Remote power switch cable
- 1 x Holder bracket

# IPC964-512-FL

4-slot Fanless Industrial System with LGA1151 Socket 7th/6th Gen Intel® Core™ i7/i5/i3 & Celeron® Processor, Intel® Q170, Front-access I/O, PCIe and PCI Slots

## Features

- LGA1151 Socket 7th/6th gen Intel® Core™ i7/i5/i3 & Celeron® processor, up to 35W (codename: Kaby Lake/Skylake)
- Intel® Q170 chipset
- Supports 4 expansion slots
- Power input: 24 VDC (uMin=19V/uMax=30V)
- Compact & front I/O design
- -10°C to +60°C operating temperature range
- Supports 2 swappable 2.5" HDD & RAID 0,1
- Supports WLAN module & antenna (optional)
- Supports TPM 2.0 (optional)



▲ Rear view

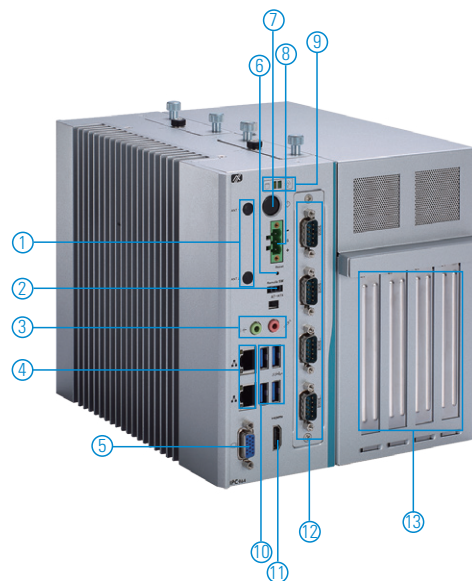

- |                        |                    |   |
|------------------------|--------------------|---|
| 1. 2 x Antenna opening | 6. Reset switch    | 12. (1) AX93511: 4 x RS-232/422/485 module (default RS-232)   |
| 2. Remote switch       | 7. Power switch    | (2) AX93512: 2 x RS-232/422/485 with isolated 1.5KVDC & 8-in/8-out with isolated 1.5KVDC DIO module |
| 3. Mic-in & Line-out   | 8. Terminal block  | (3) AX93516: 4 x RS-232/422/485 with isolated 2KVDC module  |
| 4. 2 x LAN             | 9. HDD & Power LED | (4) AX93519: 1 x 10/100/1000 Mbps Ethernet 2 x RS-232/422/485 2 x USB 3.0 module                    |
| 5. VGA                 | 10. 4 x USB 3.0    | 13. (1) AX96410: 1 PCIe x16 + 3 PCIe x4   |
|                        | 11. HDMI           | (2) AX96411: 1 PCIe x16 + 1 PCIe x4 + 2 PCI   |



## Specifications

Standard Color	Silver	
Construction	Aluminum extrusion heavy-duty cold-rolled steel, IP40	
Processor System	CPU Level	7th/6th gen Intel® Core™ i7/i5/i3 & Celeron® processor up to 35W (codename: Kaby Lake/Skylake)
	Max. Speed	3.4 GHz
	Chipset	Intel® Q170
System Memory	2 x DDR4-2133/2400 un-buffered SO-DIMM, up to 32GB	
System I/O	1 x Switch for power On/Off (ATX)	
	1 x Remote switch	
	1 x Reset switch	
	1 x 3-pin terminal block	
	1 x AT/ATX selectable switch	
	2 x 10/100/1000 Mbps Ethernet (Intel® i211-AT)	
	4 x USB 3.0	
	1 x HDMI	
	1 x VGA	
	1 x Audio (Mic-in/Line-out)	
Extension System IO Module	AX93511: 4 x RS-232/422/485 (default RS-232)	
	AX93512: 2 x RS-232/422/485 with isolated 1.5KVDC & 8-in/8-out isolated DIO	
	AX93516: 4 x RS-232/422/485 with isolated 2KVDC	
	AX93519: 1x 10/100/1000 Mbps Ethernet, 2 x RS-232/422/485 and 2 x USB 3.0 module	
TPM	TPM 2.0 (optional)	

Expansion Interface	AX96410: 1 x PCIe x16 Gen3 + 3 x PCIe x4 Gen3 AX96411: 1 x PCIe x16 Gen3 + 1 x PCIe x4 Gen3 + 2 x PCI 1 x full-size PCI Express Mini Card slot with USB & PCIe interface
Storage	2 x 2.5" swappable HDD (15 mm height), support RAID 0,1
System Indicators	1 x Power LED 1 x HDD LED
Power Input	Type: ATX/AT Input: 24 VDC (uMin=19V/uMax=30V)
Operating Temperature	-10°C to +60°C (+14°F to +140°F) with 6th gen Intel® Core™ and W.T. HDD/SSD
	-10°C to +50°C (+14°F to +122°F) with 7th gen Intel® Core™ and W.T. HDD/SSD
Storage Temperature	-20°C to +80°C (-4°F to +176°F)
Humidity	10% to 90%, non-condensing
Dimensions	188.1 mm (7.39") (W) x 192 mm (7.54") (H) x 230 mm (9.04") (D)
Weight (net/gross)	4.8 Kg (10.56 lb) / 5.9 Kg (12.98 lb)
Certifications	CE compliance

\* All specifications and photos are subject to change without notice.

## Ordering Information

System	
IPC964-512-DC-FL (P/N: E26G964A00)	4-slot fanless industrial system with 7th/6th gen Intel® Core™ i7/i5/i3 processor, Intel® Q170, and front-access I/O
IPC964-512-DC-ECM-FL (P/N: E26G964A02)	4-slot fanless EtherCAT master controller embedded industrial system with 7th/6th gen Intel® Core™ i7/i5/i3 processor and Intel® Q170, and front-access I/O

I/O Module & Riser Card	
AX93511 (P/N: 8816G962020E)	4 x RS-232/422/485 IO (default RS-232)
AX93512	2 x RS-232/422/485 with isolated 1.5KVDC & 8-in/8-out isolated DIO
AX93516 (P/N: 8816G962030E)	4 x RS-232/422/485 with isolated 2KVDC module
AX93519	1 x 10/100/1000 Mbps Ethernet, 2 x RS-232/422/485 and 2 x USB 3.0 module
726G9620610E	IPC962-511 blank I/O cover
AX96205 (P/N: 83962051000E)	1 x PCIe x16 + 3 PCIe x4
AX96206 (P/N: 83962061000E)	1 x PCIe x16 + 1 PCIe x4 + 2 PCI

Optional	
2.5" SATA HDD/SSD	
DDR4-2133/2400 un-buffered SO-DIMM, up to 32GB	
826G9640020E / 8816G9640A0E	IPC964-512-FL fan module kit
826G9620020E / 8816G9621A0E	Wall mount bracket kit
50906D24000E	Adaptor 24V/120W, wire only
AX92320 (P/N: E392320100)	4-port PCI Express GbE PoE communication card
AX92351 (P/N: E392351100)	32-in/32-out isolated 1.5KV DIO module

## Dimensions

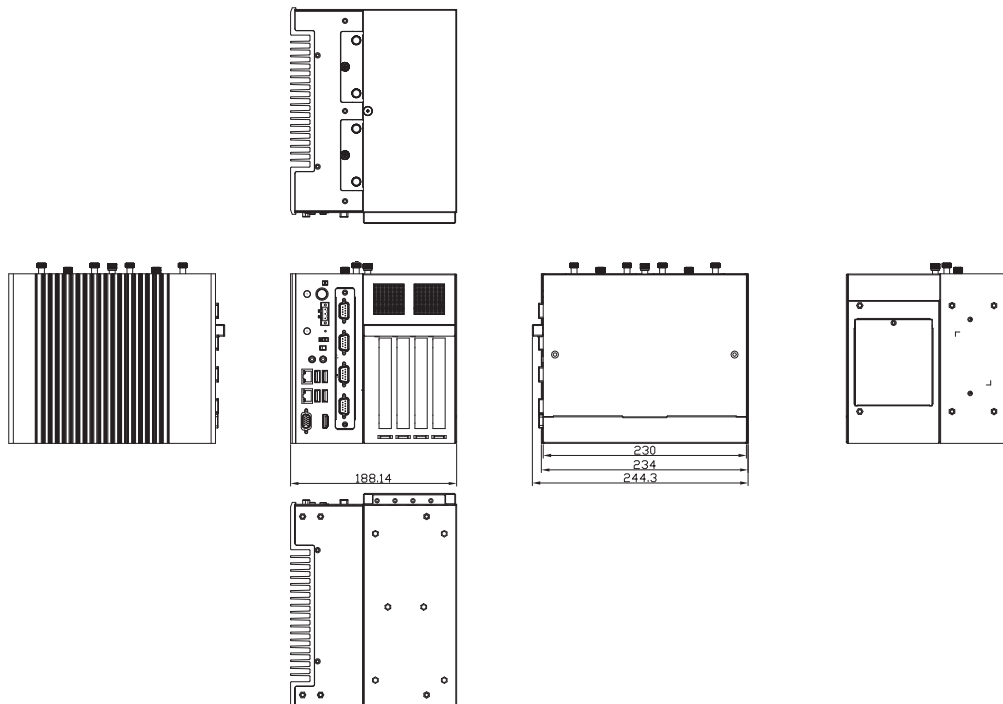

## Power Protection

DC Version
OVP (over voltage protection)
SCP (short circuit protection)
OCP (over current protection)

## Packing List

- 1 x IPC964-512-FL unit
- 1 x Driver CD
- 1 x Screw pack
- 4 x Foot pad
- 1 x CPU grease
- 1 x Terminal block
- 1 x Remote power switch cable
- 1 x Holder bracket

# IPC922-215-FL

2-slot Fanless Industrial System with Intel® Celeron® Processor J1900, Front-access I/O, PCIe and PCI Slots

## Features

- Intel® Celeron® processor J1900, up to 2.42 GHz
- Fanless & ventilation-free
- Supports 2 expansion slots
- 10 to 30 VDC to DC power supply
- Compact & front I/O design
- -10°C to +50°C operating temperature range



▲ Rear view

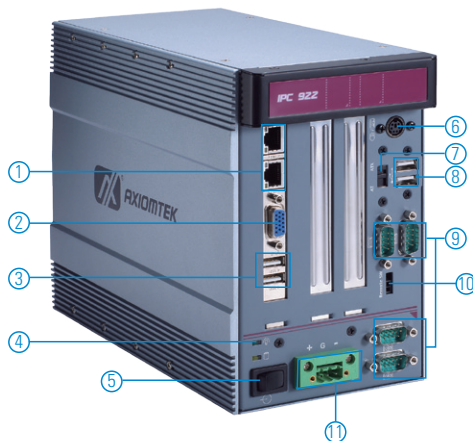

- |                     |   |
|---------------------|---|
| 1. 2 x LAN          | 7. AT/ATX mode switch                             |
| 2. VGA              | 8. 2 x USB 2.0                                    |
| 3. 2 x USB 2.0      | 9. 4 x RS-232/422/485                             |
| 4. HDD & Power LEDs | 10. Remote power switch                           |
| 5. ATX power switch | 11. Power connector<br>(Din-jack or phoenix plug) |
| 6. PS/2 connector   |   |



## Specifications

Standard Color	Silver
Construction	Aluminum extrusion heavy-duty cold-rolled steel
System Board	SHB215
Processor	CPU Level Intel® Celeron® processor J1900
System	Max. Speed 2.42 GHz
	Chipset SoC integrated
System Memory	1 x 204-pin DDR3L 1333 SO-DIMM, up to 8GB
I/O Interface	4 x USB 2.0
	4 x RS-232/422/485
	2 x 10/100/1000 Mbps Ethernet
	1 x VGA
	1 x Remote switch
	1 x Power on/off switch
Expansion Interface	1 x ATX/AT mode switch
	1 x PS/2 key broad & mouse
	HAB108: 2 x PCI
	HAB103: 1 x PCI & 1 x PCIe x4 (PCIe x4 slot only support PCIe x1 signal)

Storage	1 x 2.5" SATA HDD
	1 x Onboard CFast™ socket
System Indicators	1 x Power on/off 1 x HDD
Power Input	DC ATX 120W: Input: 10 to 30 VDC Output: +5V @ 6A, +3.3V @ 5A, +12V @ 5A, -12V @ 0.1A, 5Vsb @ 2.5A
Operating Temperature	-10°C to +50°C (14°F to +122°F)
Storage Temperature	-20°C to +80°C (-4°F to +176°F)
Humidity	10% to 90%, non-condensing
Dimensions	118 mm (4.6") (W) x 248 mm (9.8") (D) x 185 mm (7.3") (H)
Weight (net/gross)	4.22 kg (9.28 lb)/5.3 kg (11.68 lb)
Certifications	CE

## Ordering Information

System	
IPC922-215-FL-HAB103-DC (P/N: E26G922106)	2-slot fanless Industrial System with Intel® Celeron® processor J1900, PCI & PCIe slots and DC-in ATX 120W P/S
IPC922-215-FL-HAB108-DC (P/N: E26G922104)	2-slot fanless Industrial System with Intel® Celeron® processor J1900, 2 PCI slots and DC-in ATX 120W P/S

\*Specifications and certifications may vary according to various options.

### Optional

2.5" SATA HDD: 250GB, 320GB, 500GB	
DDR3 SO-DIMM: 2GB, 4GB, 8GB	
E393221100	AX93221-18/36-RC
59493221000E	AX93221 40-40P, LVDS cable, L=300 mm (RC)
71193221200E	AX93221 with bracket DVIX1 (RC)

## Power Protection

### DC Version

SCP (short circuit protection)  
OVP (over voltage protection)  
OLP (over load protection)

## Packing List

- 1 x Driver CD
- 1 x Quick manual
- 2 x Wall mount bracket
- 4 x Foot pad
- 1 x Screw pack
- 1 x Thermal pad for RAM
- 1 x Terminal block (for DC version)
- 1 x Remote power switch cable
- 1 x HDD bracket

## Dimensions

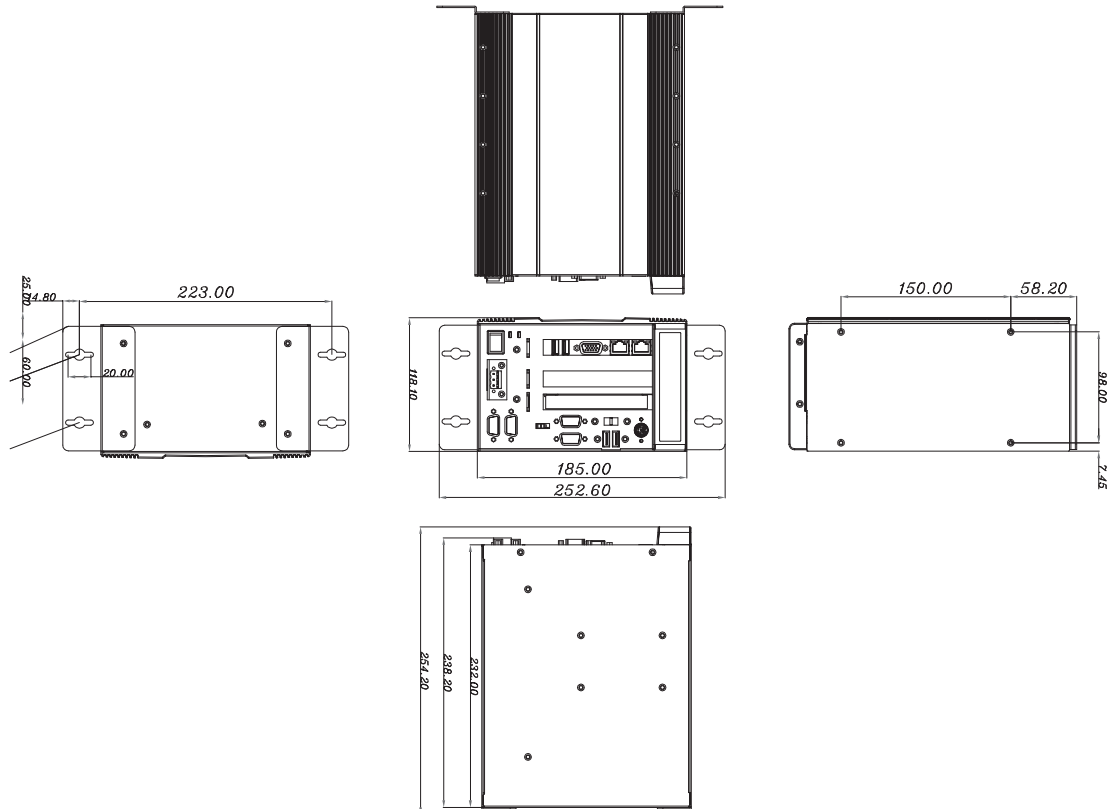

# IPC932-230-FL

2-slot Fanless Industrial System with 4th Gen Intel® Core™ i7/i5/i3 & Celeron® Processor, Intel® Q87, Front-access I/O, PCIe and PCI Slots

## Features

- 4th gen Intel® Core™ i7/i5/i3 & Celeron® processor, up to 45W (codename: Haswell/Haswell Refresh)
- Intel® Q87 chipset
- Supports 2 expansion slots
- 10 to 30 VDC to DC power supply
- Compact & front I/O design
- -10°C to +50°C operating temperature range
- Supports Intel® AMT 9.0
- Supports two 2.5" SATA HDD
- Supports SATA 6Gbs with RAID 0,1

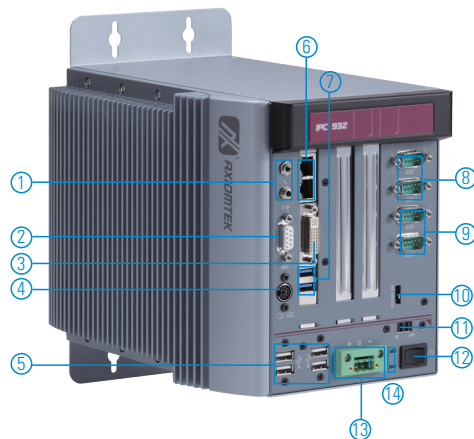

- |                          |                         |  |
|--------------------------|-------------------------|--|
| 1. Mic-in & Line-out     | 6. 2 x LAN              | 11. ATX/AT mode switch                         |
| 2. Digital I/O           | 7. 2 x USB 3.0          | 12. ATX power switch                           |
| 3. DVI-I                 | 8. RS-232/422/485       | 13. Power connector (Din-jack or phoenix plug) |
| 4. PS/2 keyboard & mouse | 9. RS-232               | 14. HDD & Power LEDs                           |
| 5. 4 x USB 2.0           | 10. Remote power switch |  |



Optional fan module helps heat dissipation generated by PCI/PCIe cards  
Size: 80 mm (W) x 80 mm (H) x 25 mm (D)

Supports 2 x SATA HDD, Easy-to-install

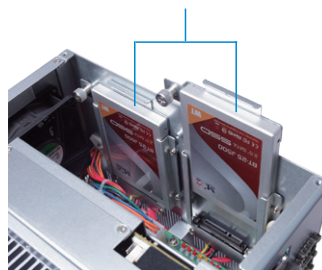

## Specifications

Standard Color	Silver
Construction	Aluminum extrusion heavy-duty cold-rolled steel, IP30
System Board	SHB230DGGGA
Processor	CPU Level Intel® Celeron® processor J1900
System	Max. Speed 2.42 GHz Chipset Intel® Q87
System Memory	2 x 204-pin DDR3-1333/1600 SO-DIMM, up to 16GB
I/O Interface	ATX power on/off switch 1 x 2-pin connector output for remote on/off switch 2 x USB 3.0 4 x USB 2.0 2 x RS-232 2 x RS-232/422/485 2 x 10/100/1000 Mbps Ethernet 1 x DVI-I 1 x DIO (Female DB9 Connector) (4-in and 4-out) 1 x PS/2 keyboard/mouse 1 x Audio (Mic-in/Line-out) 1 x AT/ATX mode switch
Expansion Interface	HAB100: 1 x PCIe x1 & 1 x PCIe x4 HAB103: 1 x PCIe x4 & 1 x PCI HAB108: 2 x PCI HAB110: 1 x PCIe x4 & 1 x PCIe x16

Storage	2 x 2.5" SATA HDD, 1 x CFast™ socket
System Indicators	1 x Power on/off 1 x HDD
Power Input	DC ATX 150W: Input: 10 to 30 VDC Output: +5V@11A, +3.3V@5A, +12V@9A, -12V@-150mA, 5Vsb@2A AC-DC power adapter: Input: 90 to 264 VAC Output: 19V@7.89A
Operating Temperature	-10°C to +55°C (+14°F to +140°F) (with W.T. SSD or CFast)
Storage Temperature	-20°C to +80°C (-4°F to +176°F)
Humidity	10% to 90%, non-condensing
Dimensions	159.9 mm (6.36") (W) x 251.8 mm (10.02") (D) x 185 mm (7.2") (H)
Weight (net/gross)	6.2 kg (13.67 lb)/7.2 kg (15.87 lb)
Certifications	CE compliance

\*\*The maximum power rating for expansion slots at +50°C can not be exceeded the following values: The maximum loading of +3.3V/1A and +5V/5A and +12V/3A <60W



## Ordering Information

### PCIe Version

IPC932-230-FL-HAB100-DC (PN: E26G932107)	2-slot fanless industrial system with 4th gen Intel® Core™ i7/i5/i3 processor and front-access I/O, PCIe slots and DC-in ATX 150W P/S
---	---

\*Specifications and certifications may vary according to various options.

### Optional

2.5" SATA HDD: 320 GB, 500 GB	
DDR3 SO-DIMM: 2GB, 4GB, 8GB	
CFast™: 2GB, 4GB, 8GB	
E26G932104	IPC932-230-FL fan module kit
594826A0010E	Y-Cable for CRT and DVI 150 mm
59381560000E	6P PS/2 KB + MS cable

## Power Protection

### AC Version

OVP (over voltage protection)
OTP (over temperature protection)
OPP (over power protection)
SCP (over circuit protection)

### DC Version

OVP (over voltage protection)
SCP (short circuit protection)
OCP (over current protection)

## Packing List

- 1 x IPC932-230-FL series unit
- 1 x 19 V 15 0W adapter (for AC Version)
- 1 x Driver CD
- 1 x Quick manual
- 2 x Wall mount bracket
- 1 x Screw pack
- 4 x Foot pad
- 1 x CPU thermal pad
- 2 x HDD bracket
- 2 x HDD mylar
- 1 x Terminal block (for DC version)
- 1 x Remote power switch cable

## Dimensions

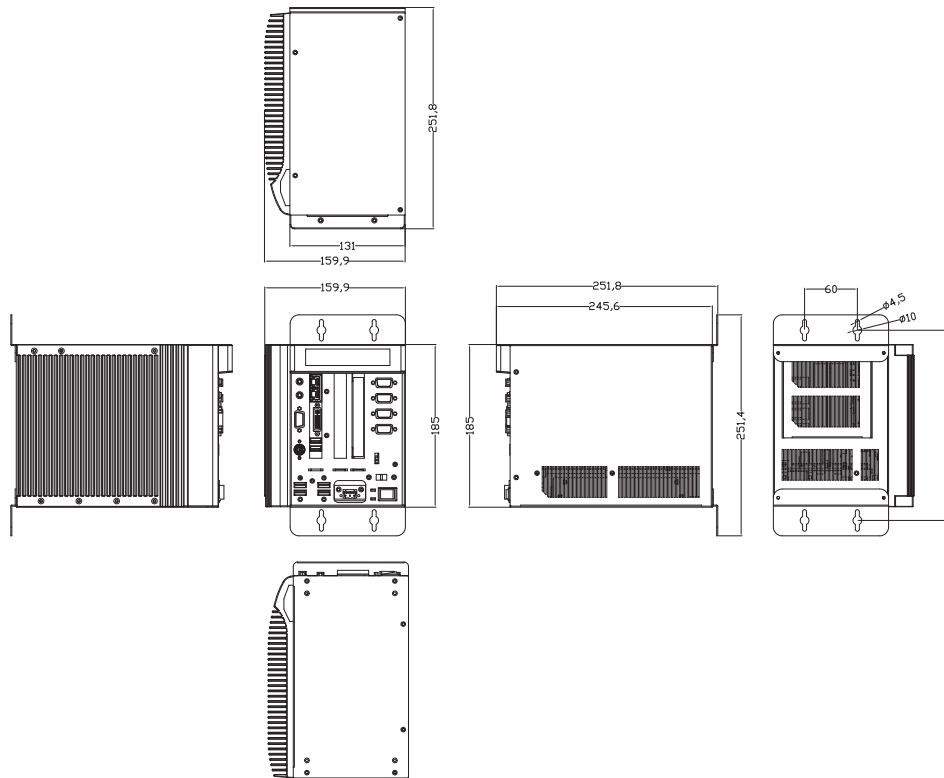

# IPC310-501 NEW

Wall Mount Industrial System with LGA1151 Socket 7th/6th Gen Intel® Core™ Processor, Intel® H110, USB 3.0, SATA 3.0, Dual LANs, VGA, DisplayPort, HDMI and mSATA

## Features

- Wall mount industrial computer chassis
- LGA1151 socket 7th/6th gen Intel® Core™ i7/i5/i3, Pentium® & Celeron® processor (Kaby Lake/Skylake)
- 2 288-pin DDR4-2133/1866 DIMM, up to 32GB
- DisplayPort, HDMI and VGA with dual-view supported
- 3 SATA-600
- 4 USB 3.0 and 4 USB 2.0
- Supports mSATA and PCI Express Mini Card slot



## Specifications

CPU	LGA1151 socket 7th/6th gen Intel® Core™ i7/i5/i3, Pentium® & Celeron® processor						
System Memory	2 x 288-pin DDR4-2133/1866 DIMM, up to 32GB						
Chipset	Intel® H110						
Display	Intel® HD Graphic Share system memory						
BIOS	AMI BIOS						
Watchdog Timer	255 levels, 1 to 255 sec.						
Expansion Interface	1 x PCIe x16 2 x PCIe x4 slot (only support x1 signal) 4 x PCI 1 x PCI Express Mini Card slot 1 x SIM						
I/O	<table border="0"> <tr> <td>External</td> <td>1 x PS/2 keyboard &amp; mouse 1 x RS-232/422/485 4 x USB 3.0 1 x DisplayPort 1 x HDMI 1 x VGA 2 x 10/100/1000 Mbps Ethernet (Intel® i219-LM &amp; Intel® i210) 1 x Audio (Mic-in/Line-in/Line-out)</td> </tr> <tr> <td>Internal</td> <td>4 x RS-232 (internal box header) 1 x RS-232/422/485 (internal box header) 2 x USB 2.0 (internal 2.54-pin header) 1 x 8-CH programmable DIO</td> </tr> </table>	External	1 x PS/2 keyboard & mouse 1 x RS-232/422/485 4 x USB 3.0 1 x DisplayPort 1 x HDMI 1 x VGA 2 x 10/100/1000 Mbps Ethernet (Intel® i219-LM & Intel® i210) 1 x Audio (Mic-in/Line-in/Line-out)	Internal	4 x RS-232 (internal box header) 1 x RS-232/422/485 (internal box header) 2 x USB 2.0 (internal 2.54-pin header) 1 x 8-CH programmable DIO		
External	1 x PS/2 keyboard & mouse 1 x RS-232/422/485 4 x USB 3.0 1 x DisplayPort 1 x HDMI 1 x VGA 2 x 10/100/1000 Mbps Ethernet (Intel® i219-LM & Intel® i210) 1 x Audio (Mic-in/Line-in/Line-out)						
Internal	4 x RS-232 (internal box header) 1 x RS-232/422/485 (internal box header) 2 x USB 2.0 (internal 2.54-pin header) 1 x 8-CH programmable DIO						
Storage	3 x SATA-600 1 x mSATA						
Hardware Monitoring	Detect CPU/system temperature, voltage and supports Smart fan control						
SMBus	Yes						
Front panel	<table border="0"> <tr> <td>LED Indicators</td> <td>1 x power on/off 1 x HDD</td> </tr> <tr> <td>Control</td> <td>1 x power button 1 x reset button</td> </tr> <tr> <td>I/O</td> <td>2 x USB 2.0</td> </tr> </table>	LED Indicators	1 x power on/off 1 x HDD	Control	1 x power button 1 x reset button	I/O	2 x USB 2.0
LED Indicators	1 x power on/off 1 x HDD						
Control	1 x power button 1 x reset button						
I/O	2 x USB 2.0						
Power Input	350W ATX						

Operating Temperature	0°C to +40°C (+32°F to +104°F)
Storage Temperature	-20°C to +80°C (-4°F to +176°F)
Humidity	10% to 90%, non-condensing
Dimensions	196 mm (7.716") (W) x 407.4 mm (16.039") (D) x 330 mm (12.992") (H)
Weight (net/gross)	12 kg (26.49 lb)/13.3 kg (29.36 lb)
Certifications	CE compliance

## Ordering Information

System	
IPC310-501WM-US (P/N:E26G310100)	Wall mount industrial system with Intel® Core™ i7/i5/i3 & Celeron® processor, Intel® H110 chipset and 350W power supply

## Dimensions

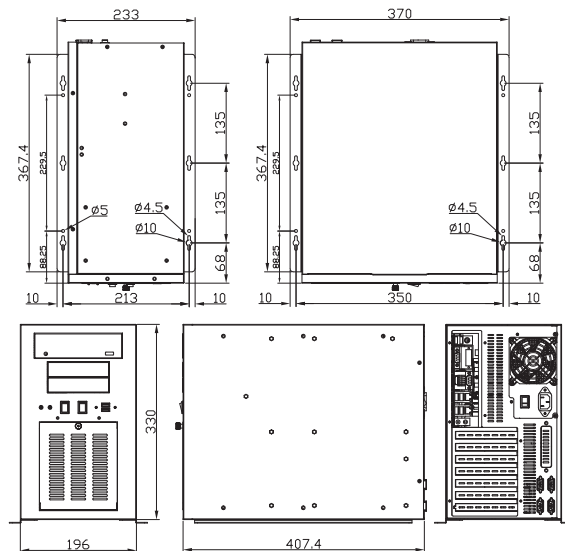





# 7

## Intelligent Platform Solutions

Axiomtek's IPS series is designed to focus on vision inspection, guidance, measurement and identification applications. The products have already gone through a complete set of compatibility experiments to eliminate potential integration problems, significantly helping users reduce development and staffing costs as well as accelerate system deployment in factory automation environment.

Selection Guide		220
 IPS960-511-PoE	Vision System with LGA1151 Socket 7th/6th Gen Intel® Core™ i7/i5/i3 & Celeron®, Intel® H110, 4 PoE, 4 USB 3.0, and Real-time Vision I/O	221
 IPS962-512-PoE	Vision System with LGA1151 Socket 7th/6th Gen Intel® Core™ i7/i5/i3 & Celeron®, Intel® Q170, 4 PoE, 4 USB 3.0, and Real-time Vision I/O	223

## Systems and Platforms

# Intelligent Platform Solutions

## Selection Guide



Features/Models	IPS960-511-PoE	IPS962-512-PoE
<b>CPU Level</b>	7th/6th gen Intel® Core™ i7/i5/i3 & Celeron®, up to 35W	7th/6th gen Intel® Core™ i7/i5/i3 & Celeron®, up to 35W
<b>System Memory</b>	2 x DDR4-2133 un-buffered SO-DIMM, up to 32GB	2 x DDR4-2133/2400 un-buffered SO-DIMM, up to 32GB
<b>Chipset</b>	Intel® H110	Intel® Q170
<b>Vision I/O</b>	4 x trigger input 4 or 8 x trigger output 4 x LED lighting control 1 x quadrature encoder input 16 x isolated DIO 1 x auto measurement function	4 x trigger input 4 or 8 x trigger output 4 x LED lighting control 1 x quadrature encoder input 16 x isolated DIO 1 x auto measurement function
<b>Display</b>	1 x HDMI 1 x VGA	1 x HDMI 1 x VGA
<b>Audio</b>	Yes	Yes
<b>PoE</b>	4 x IEEE802.3at GbE LAN port	4 x IEEE802.3at GbE LAN port
<b>Ethernet</b>	2 x 10/100/1000 Mbps Ethernet	2 x 10/100/1000 Mbps Ethernet
<b>USB</b>	4 x USB 3.0	4 x USB 3.0
<b>I/O Expansion Module</b>	AX93511: 4 x RS-232/422/485 (default RS-232) AX93512: 2 x isolated RS-232/422/485 & 1 x isolated 8-in/8-out DIO AX93516: 4 x isolated RS-232/422/485 AX93519: 1 x 10/100/1000 Mbps Ethernet, 2 x USB 3.0 & 2 x RS-232/422/485 (default RS-232)	AX93511: 4 x RS-232/422/485 (default RS-232) AX93512: 2 x isolated RS-232/422/485 & 1 x isolated 8-in/8-out DIO AX93516: 4 x isolated RS-232/422/485 AX93519: 1 x 10/100/1000 Mbps Ethernet, 2 x USB 3.0 & 2 x RS-232/422/485 (default RS-232)
<b>Expansion Interface</b>	1 x Full-size PCI Express Mini Card slot with USB interface	1 x PCIe x16 Gen3 1 x PCIe x4 Gen3 1 x Full-size PCI Express Mini Card slot with USB & PCIe interface
<b>Storage</b>	2 x Swappable 2.5" HDD	2 x Swappable 2.5" HDD
<b>TPM</b>	TPM 2.0	TPM 2.0
<b>Watchdog Timer</b>	255 levels, 1 to 255 sec.	255 levels, 1 to 255 sec.
<b>Power Input</b>	24 VDC (uMin=19V/uMax=30V)	24 VDC (uMin=19V/uMax=30V)
<b>Operating Temperature</b>	-10°C to +55°C (+14°F to +131°F) with 6th gen CPU -10°C to +45°C (+14°F to +113°F) with 7th gen CPU	-10°C to +55°C (+14°F to +131°F) with 6th gen CPU -10°C to +45°C (+14°F to +113°F) with 7th gen CPU
<b>Dimensions (W x D x H)</b>	147.5 x 192 x 230 mm (5.80" x 7.54" x 9.04")	188.1 x 192 x 230 mm (7.39" x 7.54" x 9.04")
<b>Weight (net/gross)</b>	4.582 kg (10.10lb)/5.546 kg (12.23lb)	5 Kg (11.02 lb)/6.1 Kg (13.45 lb)
<b>Mounting</b>	Wall Mount	Wall Mount
<b>Certifications</b>	CE compliance	CE compliance
<b>EOS Support</b>	6th gen platform: Win 7 32/64-bit & Win 10 64-bit 7th gen platform: Win 10 64-bit	6th gen platform: Win 7 32/64-bit & Win 10 64-bit 7th gen platform: Win 10 64-bit



Intelligent Platform Solutions

# IPS960-511-PoE NEW

Vision System with LGA1151 Socket 7th/6th Gen Intel® Core™ i7/i5/i3 & Celeron®, Intel® H110, 4 PoE, 4 USB 3.0, and Real-time Vision I/O

## Features

- Integrated real-time vision I/O
  - 4 CH trigger input
  - 4 or 8 CH trigger output
  - 4 CH LED lighting control
  - 1 CH quadrature encoder input
  - 16 CH isolated DIO
  - 1 CH auto measurement function
- Supports camera interfaces
  - 4 IEEE802.3at GbE LAN ports (PoE)
  - 4 USB 3.0 ports
- Power input: 24 VDC (uMin=19V/uMax=30V)
- -10°C to +55°C operating temperature range
- Supports 2 swappable 2.5" HDD
- Supports optional WLAN module & antenna
- Supports TPM 2.0 function
- Compact & front I/O design

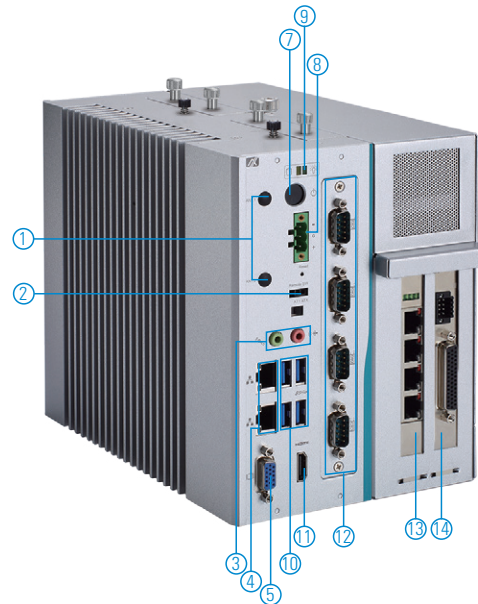

- |                        |                   |   |
|------------------------|-------------------|---|
| 1. 2 x Antenna opening | 7. Power switch   | 12. I/O module slot   |
| 2. Remote switch       | 8. Terminal block | (1) AX93511: 4 x RS-232/422/485 (default RS-232)  |
| 3. Mic-in & Line-out   | 9. HDD/Power LED  | (2) AX93512: 2 x RS-232/422/485 & 1 x 8-in/8-out DIO with isolated 1.5 kVDC protection        |
| 4. 2 x LAN             | 10. 4 x USB 3.0   | (3) AX93516: 4 x RS-232/422/485 with isolated 1.5 kV protection                               |
| 5. VGA                 | 11. HDMI          | (4) AX93519: 1 x 10/100/1000 Mbps Ethernet, 2 x USB 3.0 & 2 x RS-232/422/485 (default RS-232) |
| 6. Reset switch        |                   | 13. 4 x IEEE802.3at GbE LAN port  |
|                        |                   | 14. Real-time vision I/O  |



## Specifications

Standard Color	Silver	
Construction	Aluminum extrusion heavy-duty cold-rolled steel, IP40	
Processor System	CPU Level	7th/6th gen Intel® Core™ i7/i5/i3 & Celeron® processors, up to 35W (Kaby Lake/Skylake)
	Max. Speed	3.4 GHz
	Chipset	Intel® H110
System Memory	2 x DDR4-2133/2400 un-buffered SO-DIMM, up to 32GB	
System I/O	1 x Switch for power On/Off (ATX) 1 x Remote switch 1 x Reset switch 1 x 3-pin terminal block 1 x AT/ATX selectable switch 2 x 10/100/1000 Mbps Ethernet (Intel® i211-AT) 4 x IEEE802.3at GbE LAN port (Intel® i210-AT, IEEE802.3at compliant, total max. power output 60W) 1 x Real-time vision I/O 4 x USB 3.0 1 x HDMI 1 x VGA 1 x Mic-in 1 x Line-out	
I/O Expansion Modules	AX93511: 4 x RS-232/422/485 (default RS-232) AX93512: 2 x RS-232/422/485 & 1 x 8-in/8-out DIO with isolated 1.5 kVDC protection AX93516: 4 x RS-232/422/485 with isolated 1.5 kV protection AX93519: 1 x 10/100/1000 Mbps Ethernet, 2 x USB 3.0 & 2 x RS-232/422/485 (default RS-232)	
TPM	TPM 2.0	

Vision I/O	- 4 CH trigger input (response time<1us, sink type, input range: 0 to 30V) - 4 or 8 CH trigger output (response time<1 us, output voltage: 12V) - 4 CH LED lighting control (24V, Max. 0.5A per channel, LED lighting control setting: Duty 50% and duration time 3.5s) - 1 CH quadrature encoder input (A/B/Z) - 8 CH isolated DI (sink/source type, input range: 0 to 30V) - 8 CH isolated DO (sink type, open collector, supply voltage: 5-30V) - 1 CH auto measurement function (Timer that measures response interval between trigger input and trigger output) - Programmable interrupt functions
Camera Interface	4 x IEEE802.3at GbE LAN port (PoE) 4 x USB 3.0 port
Expansion Interface	1 x Full-size PCI Express Mini Card slot with USB interface
Storage	2 x 2.5" swappable HDD (15 mm height)
System Indicators	1 x Power LED 1 x HDD LED
Power Input	Type: ATX/AT Input: 24 VDC (uMin=19V/uMax=30V)
Operating Temperature	-10°C to +55°C (+14°F to +131°F) with 6th gen Intel® Core™ and W.T. HDD or W.T. SSD -10°C to +45°C (+14°F to +113°F) with 7th gen Intel® Core™ and W.T. HDD or W.T. SSD
Storage Temperature	-20°C to +80°C (-4°F to +176°F)
Humidity	10% to 90%, non-condensing
Dimensions	188.1 mm (7.39") (W) x 192 mm (7.54") (H) x 230 mm (9.04") (D)
Weight (net/gross)	4.582 kg (10.10lb)/5.546 kg (12.23lb)
Certifications	CE compliance



## Ordering Information

System	
IPS960-511-PoE	Vision system with 7th/6th gen Intel® Core™ i7/i5/i3 processor and Intel® H110
I/O Modules	
AX93511 (P/N: 8816G962020E)	4 x RS-232/422/485 (default RS-232)
AX93512	2 x RS-232/422/485 & 8-in/8-out DIO with isolated 1.5 kVDC protection
AX93516 (P/N: 8816G962030E)	4 x RS-232/422/485 with isolated 1.5 kV
AX93519	1 x 10/100/1000 Mbps Ethernet, 2 x USB 3.0 & 2 x RS-232/422/485 (default RS-232)
726G9620610E	Blank metal cover

### Optional

2.5" SATA HDD/SSD	
DDR4-2133/2400 un-buffered SO-DIMM max. up to 32GB	
826G9620020E / 8816G9621A0E	Wall mount bracket kit
50906D24000E	Adaptor 24V/120W, wire only
E981806008	44-pin DIN-rail terminal board DM44-AP12
E981806013	44-pin D-SUB cable, L=1m WHDM44/1.0-6954
E981806014	44-pin D-SUB cable, L=2m WHDM44/2.0-6954
E981806015	44-pin D-SUB cable, L=3m WHDM44/3.0-6954

\* Specifications and certifications may vary based on different requirements.

## Power Protection

### DC Version

OVP (over voltage protection)
SCP (short circuit protection)
OCP (over current protection)

## Packing List

1 x IPS960-511-PoE
1 x Driver CD
1 x Screw pack
4 x Foot pad
1 x CPU grease
1 x Terminal block
1 x Remote power switch cable
1 x Holder bracket

## Dimensions

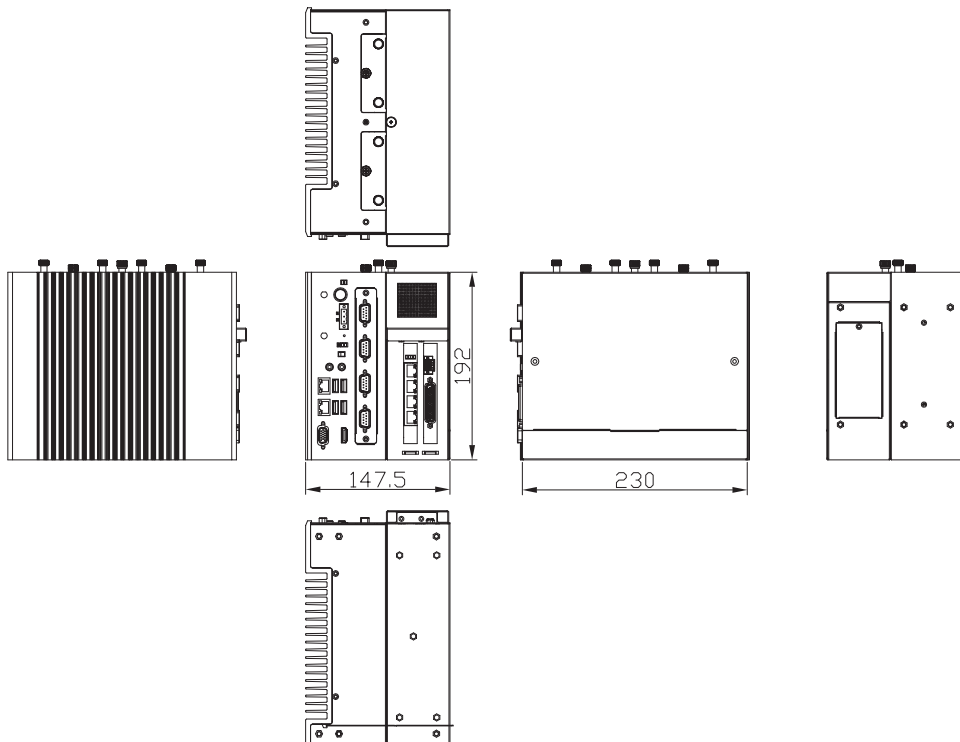

# IPS962-512-PoE NEW

Vision System with LGA1151 Socket 7th/6th Gen Intel® Core™ i7/i5/i3 & Celeron®, Intel® Q170, 4 PoE, 4 USB 3.0, and Real-time Vision I/O

## Features

- Integrated real-time vision I/O
  - 4 CH trigger input
  - 4 or 8 CH trigger output
  - 4 CH LED lighting control
  - 1 CH quadrature encoder input
  - 16 CH isolated DIO
  - 1 CH auto measurement function
- Supports camera interfaces
  - 4 IEEE802.3at GbE LAN ports (PoE)
  - 4 USB 3.0 ports
- Power input: 24 VDC (uMin=19V/uMax=30V)
- -10°C to +55°C operating temperature range with W.T. SSD
- Supports 2 swappable 2.5" HDD
- Supports optional WLAN module & antenna
- Supports TPM 2.0 function
- Compact & front I/O design

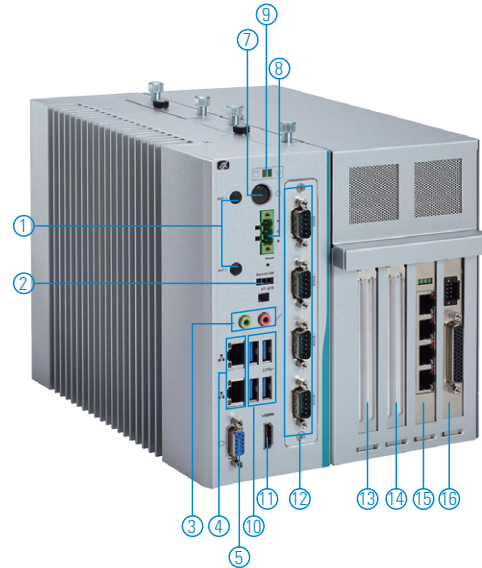

- |                        |                   |   |
|------------------------|-------------------|---|
| 1. 2 x Antenna opening | 7. Power switch   | 12. I/O module slot   |
| 2. Remote switch       | 8. Terminal block | (1) AX93511: 4 x RS-232/422/485 (default RS-232)  |
| 3. Mic-in & Line-out   | 9. HDD/Power LED  | (2) AX93512: 2 x RS-232/422/485 & 1 x 8-in/8-out DIO with isolated 1.5 kVDC protection        |
| 4. 2 x LAN             | 10. 4 x USB 3.0   | (3) AX93516: 4 x RS-232/422/485 with isolated 1.5 kV protection                               |
| 5. VGA                 | 11. HDMI          | (4) AX93519: 1 x 10/100/1000 Mbps Ethernet, 2 x USB 3.0 & 2 x RS-232/422/485 (default RS-232) |
| 6. Reset switch        |                   | 13. 1 x PCIe x16 slot   |
|                        |                   | 14. 1 x PCIe x4 slot  |
|                        |                   | 15. 4 x IEEE802.3at GbE LAN port  |
|                        |                   | 16. Real-time vision I/O  |



## Specifications

Standard Color	Silver
Construction	Aluminum extrusion heavy-duty cold-rolled steel, IP40
Processor System	CPU Level 7th/6th gen Intel® Core™ i7/i5/i3 & Celeron® processors, up to 35W (Kaby Lake/Skylake)
	Max. Speed 3.4 GHz
	Chipset Intel® Q170
System Memory	2 x DDR4-2133/2400 un-buffered SO-DIMM, up to 32GB
System I/O	1 x Switch for power On/Off (ATX) 1 x Remote switch 1 x Reset switch 1 x 3-pin terminal block 1 x AT/ATX selectable switch 2 x 10/100/1000 Mbps Ethernet (Intel® i211-AT) 4 x IEEE802.3at GbE LAN port (Intel® i210-AT, IEEE802.3at compliant, total max. power output 60W) 1 x Real-time vision I/O 4 x USB 3.0 1 x HDMI 1 x VGA 1 x Mic-in 1 x Line-out
I/O Expansion Modules	AX93511: 4 x RS-232/422/485 (default RS-232) AX93512: 2 x RS-232/422/485 & 1 x 8-in/8-out DIO with isolated 1.5 kVDC protection AX93516: 4 x RS-232/422/485 with isolated 1.5 kV protection AX93519: 1 x 10/100/1000 Mbps Ethernet, 2 x USB 3.0 & 2 x RS-232/422/485 (default RS-232)
TPM	TPM 2.0

Vision I/O	- 4 CH trigger input (response time<1us, sink type, input range: 0 to 30V) - 4 or 8 CH trigger output (response time<1us, output voltage: 12V) - 4 CH LED lighting control (24V, Max. 0.5A per channel, LED lighting control setting: Duty 50% and duration time 3.5s) - 1 CH quadrature encoder input (A/B/Z) - 8 CH isolated DI (sink/source type, input range: 0 to 30V) - 8 CH isolated DO (sink type, open collector, supply voltage: 5-30V) - 1 CH auto measurement function (Timer that measures response interval between trigger input and trigger output) - Programmable interrupt functions
Camera Interface	4 IEEE802.3at GbE LAN port (PoE) 4 USB 3.0 port
Expansion Interface	1 x PCIe x16 Gen3 1 x PCIe x4 Gen3 1 x Full-size PCI Express Mini Card slot with USB & PCIe interface
Storage	2 x 2.5" swappable HDD (15 mm height) (RAID 0,1)
System Indicators	1 x Power LED 1 x HDD LED
Power Input	Type: ATX/AT Input: 24 VDC (uMin=19V/uMax=30V)
Operating Temperature	-10°C to +55°C (+14°F to +131°F) with 6th gen Intel® Core™ and W.T. HDD or W.T. SSD -10°C to +45°C (+14°F to +113°F) with 7th gen Intel® Core™ and W.T. HDD or W.T. SSD
Storage Temperature	-20°C to +80°C (-4°F to +176°F)
Humidity	10% to 90%, non-condensing
Dimensions	188.1 mm (7.39") (W) x 192 mm (7.54") (H) x 230 mm (9.04") (D)
Weight (net/gross)	5 Kg (11.02 lb) / 6.1 Kg (13.45 lb)
Certifications	CE compliance

## Ordering Information

System	
IPS962-512-PoE	Vision system with 7th/6th gen Intel® Core™ i7/i5/i3 processor and Intel® Q170
I/O Modules	
AX93511 (P/N: 8816G962020E)	4 x RS-232/422/485 (default RS-232)
AX93512	2 x RS-232/422/485 with isolated 1.5 kVDC protection & 8-in/8-out DIO with isolated 1.5 kVDC protection
AX93516 (PN: 8816G962030E)	4 x RS-232/422/485 with isolated 1.5 kV
AX93519	1 x 10/100/1000 Mbps Ethernet, 2 x USB 3.0 & 2 x RS-232/422/485 (default RS-232)
726G9620610E	Blank metal cover

### Optional

2.5" SATA HDD/SSD	
DDR4-2133/2400 un-buffered SO-DIMM max. up to 32GB	
AX92351	32-in/32-out isolated 1.5 kV DIO module
826G9620020E / 8816G9621A0E	Wall mount bracket kit
50906D24000E	Adaptor 24V/120W, wire only
E981806008	44-pin DIN-rail terminal board DM44-AP12
E981806013	44-pin D-SUB cable, L=1m WHDM44/1.0-6954
E981806014	44-pin D-SUB cable, L=2m WHDM44/2.0-6954
E981806015	44-pin D-SUB cable, L=3m WHDM44/3.0-6954

\* Specifications and certifications may vary based on different requirements.

## Power Protection

### DC Version

OVP (over voltage protection)
SCP (short circuit protection)
OCV (over current protection)

## Packing List

1 x IPS962-512-PoE
1 x Driver CD
1 x Screw pack
4 x Foot pad
1 x CPU grease
1 x Terminal block
1 x Remote power switch cable
1 x Holder bracket

## Dimensions

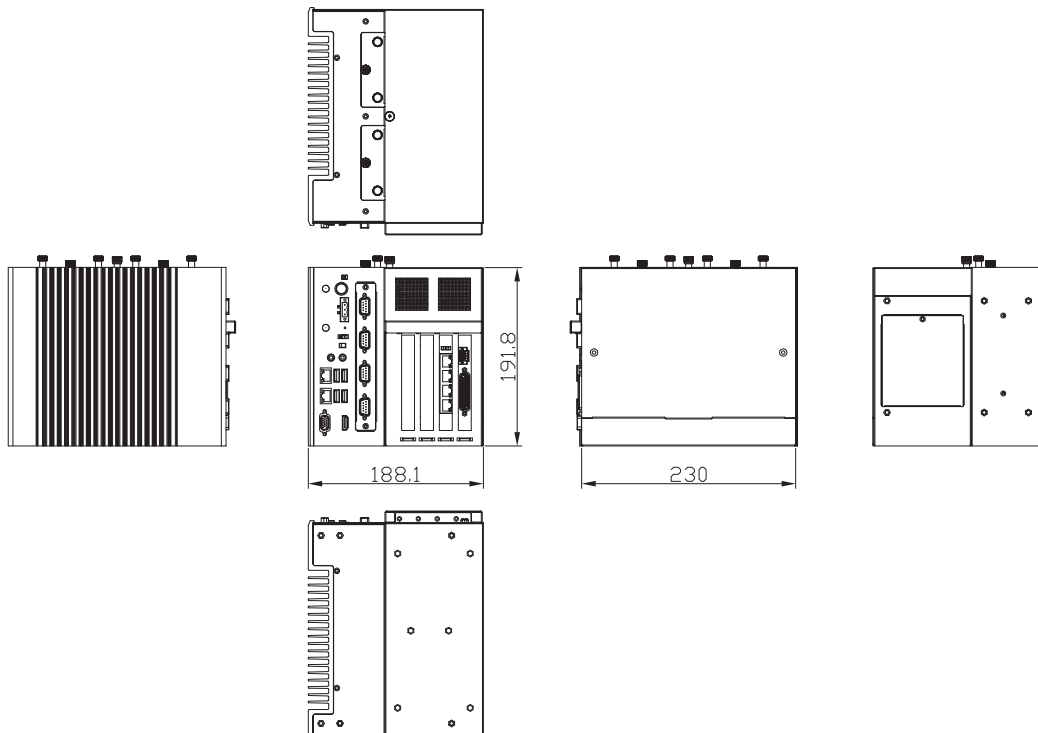



Embedded Systems

Transportation Embedded Systems

DIN-rail Embedded Systems

Digital Signage Players

Embedded MicroBoxes

Industrial Systems

Intelligent Platform Solutions

Industrial Chassis

# Systems and Platforms

# 8

## Industrial Chassis

Axiomtek's industrial chassis are easy maintainable, flexible design, reliable quality; abundant choice for two categories which are Backplane type and motherboard type. Axiomtek have various chassis, such as rack-mount for 1U, 2U, 4U, shoebox, wallmount, etc, for different application fields. Axiomtek have diversity of industrial know-how to supply right product in right application.

Selection Guide		227
AX60501	6-slot ShoeBox Chassis	228
 AX60810	Wall Mount Chassis for ATX & mATX Standard Board	229
AX61131TM	1U Cost-effective Rackmount Chassis for ATX Motherboard	231
AX61223TM	2U Rackmount Chassis for ATX Motherboard	233
AX61410	4U 14-slot Rackmount Chassis	235
AX6156LE	COM Express Type 10 Mini Module with Intel® Pentium® Processor N4200 & Celeron® Processor N3350	237

# Industrial Chassis

## Selection Guide



Features/Models	AX60501	AX60810	AX61131TM
<b>Height</b>	-	-	1U
<b>Number of Slots</b>	6	7	1
<b>Backplane Selection</b>	FAB105, FAB109, FAB110, HAB206, ATX6022/6	N/A	N/A
<b>MB Support</b>	N/A	Yes, 12" x 9.6"(ATX), 9.6" x 9.6"(mATX)	Yes, 12" x 9.6" (ATX)
<b>Drive Capacity</b>	5.25"	1	N/A
	3.5"	2 (1 internal)	2 (internal)
<b>Cooling System</b>	1 x 9 cm	1 x 12 cm (with a removable filter)	2 x 4 cm
<b>Fault Detection</b>	N/A	N/A	N/A
<b>Power Supply</b>	PS/2 type	PS/2 type	1U type
<b>Dimensions (W x D x H)</b>	235 x 400 x 154.7 mm (9.25" x 15.8" x 6.1")	196 x 407.4 x 330 mm (7.716" x 16.039" x 12.992")	440 x 428 x 44mm (17.3" x 16.8" x 1.73")
<b>Weight (net/gross)</b>	9 kg (19.84 lb)/10.3 kg (22.7 lb)	9 kg (19.84 lb)/10.3 kg (22.7 lb)	9.8 kg (21.6 lb)/10.8 kg (23.81 lb)



Features/Models	AX61223TM	AX61410	AX6156LE
<b>Height</b>	2U	4U	4U
<b>Number of Slots</b>	2	14	14
<b>Backplane Selection</b>	N/A	FAB100, FAB101, FAB112, FAB113, FAB114, FAB118, FAB119, ATX6022/14, ATX6022/14G, ATX6022/13L, ATX6022/14GP7	FAB100, FAB101, FAB112, FAB113, FAB114, FAB118, FAB119, ATX6022/14, ATX6022/14G, ATX6022/14G, ATX6022/13
<b>MB Support</b>	Yes, 12" x 9.6" (ATX)	Yes, 12" x 9.6" (ATX)	Yes, 12" x 9.6" (ATX)
<b>Drive Capacity</b>	5.25"	1	3
	3.5"	3 (2 internal)	2 (1 internal)
<b>Cooling System</b>	1 x 8 cm	1 x 12 cm	1 x 12 cm
<b>Fault Detection</b>	N/A	N/A	N/A
<b>Power Supply</b>	PS/2 type	PS/2 type	PS/2 type (optional HRP)
<b>Dimensions (W x D x H)</b>	482.6 x 450 x 88 mm (19" x 17.7" x 3.5")	482.6 x 450 x 177 mm (19" x 17.7" x 7")	484.7 x 537.6 x 176.7 mm (19" x 21.2" x 7")
<b>Weight (net/gross)</b>	12 kg (26.45 lb)/13.5 kg (29.77 lb)	15 kg (33.07 lb)/16.3 kg (35.94 lb)	18 kg (39.68 lb)/19.5 kg (43 lb)



# AX60501

## 6-slot ShoeBox Chassis

### Features

- Desktop or wallmount industrial computer chassis
- One 5.25" and two 3.5" HDD drive bays
- Equipped with a PS/2 type power supply

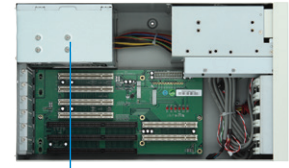

▲ Top view

Equipped with a power supply bracket securing the power supply better when the chassis is positioned in 90° orientation

### Specifications

Standard Color	Beige	
Construction	Heavy-duty steel	
Drive Capacity	Exposed	1 x 5.25" HDD drive bay 1 x 3.5" HDD drive bay
	Internal	1 x 3.5" HDD drive bay
Cooling	1 x 9 cm ball-bearing fan (51 CFM/each) with a removable filter	
Front Panel Indicators	1 x Power on/off	
Front Panel Controls	1 x Power on/off	
	1 x System reset	
Front Panel Connector	1 x PS/2 6-pin keyboard & mouse	
	2 x USB	
System Board	SBCs	
Expansion Interface	6-slot backplane	
Operating Temperature	0°C to +40°C (+32°F to +104°F)	
Dimensions	240.2 mm (9.45") (W) x 401.4 mm (15.8") (D) x 154.7 mm (6.1") (H)	
Weight (net/gross)	9 kg (19.84 lb)/10.3 kg (22.7 lb)	

### Power Supply Specifications

Items	Watt	Input	Specifications Output	MTBF
PS302-XP2	ATX 300W (PFC)	AC 100 to 240V (Auto)	+5V @ 16A	100,000 hours
			+12V1 @ 17A	
			+12V2 @ 17A	
			-12V @ 0.3A	
			+3.3V @ 19A	
+5VSB @ 2.5A				

### Dimensions

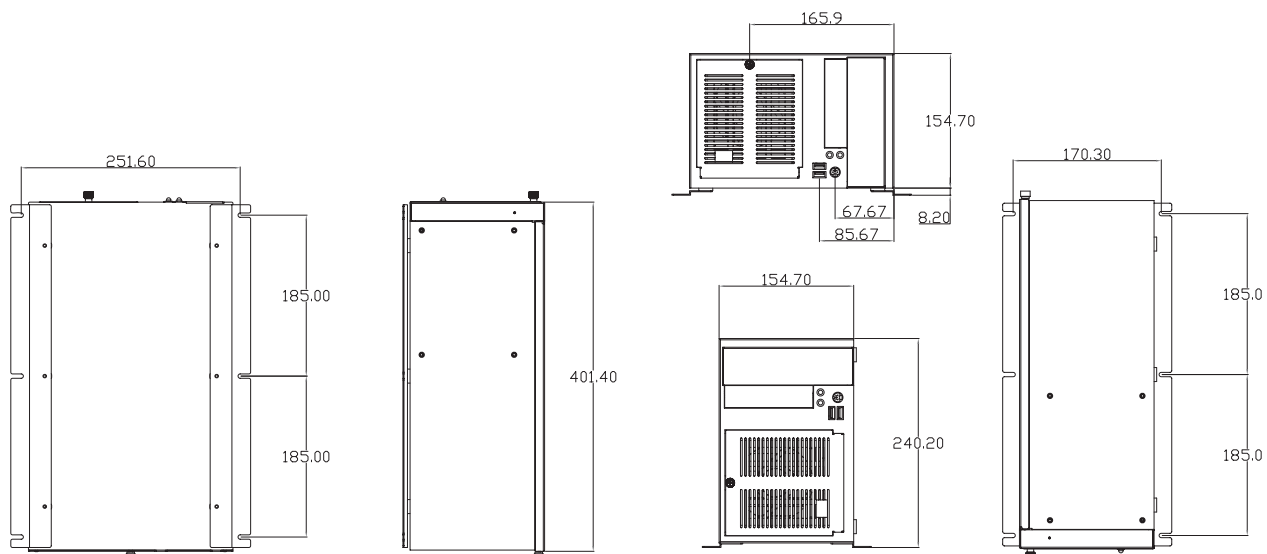

### Ordering Information

AX60501WB/X300	6-slot shoebox chassis with ATX 300W power supply
AX60501WB/X400	6-slot shoebox chassis with ATX 400W power supply
AX60501WB/X500	6-slot shoebox chassis with ATX 500W power supply

\*Specifications and certifications are based on options and may vary.

### Backplane Options

#### PICMG 1.0

Models	Slots per Segment (ISA/PCI/PCIE/CPU)	Segment
ATX6022/6	1/4/0/1	Single

#### PICMG 1.3

Models	Slots per Segment (ISA/PCI/PCIE/CPU)	Segment
FAB105	0/3/1/1	Single
FAB109	0/0/4/1	Single
FAB110	0/2/2/1	Single
HAB206	0/3/1/1	Single

### Optional Items

- ATX 400W power supply with PFC
- ATX 500W power supply with PFC

# AX60810 NEW

Wall Mount Chassis for ATX and Micro-ATX Motherboards

## Features

- Supports ATX/micro-ATX motherboard
- Front-accessible one 5.25" HDD and two 3.5" HDD drive bays
- Equipped with a PS/2 type power supply
- One 12cm ball-bearing fan
- Bidirectional mounting chassis
- Easy removable filter
- Flexible I/O opening on rear



▲ Top view



▲ Rear view

## Specifications

Standard Color	Warm gray
Construction	Heavy-duty steel
System Board	ATX or mATX
Drive Capacity	Exposed 1 x 5.25" HDD drive bay 2 x 3.5" HDD drive bays
Cooling	1 x 12cm DC fan with a removable filter
Front Panel Indicators	1 x Power on/off 1 x HDD
Front Panel Controls	1 x Power on/off 1 x System reset
Front Panel Connector	2 x USB
Operating Temperature	0°C to +40°C (+32°F to +104°F)
Dimensions	196 mm (7.716") (W) x 407.4 mm (16.039") (D) x 330 mm (12.992") (H)
Weight (net/gross)	9 kg (19.84 lb)/10.3 kg (22.7 lb)

## Ordering Information

AX60810WM/X300W	Wall mount chassis with ATX 300W power supply
AX60810WM/X400W	Wall mount chassis with ATX 400W power supply
AX60810WM/X500W	Wall mount chassis with ATX 500W power supply

\*Specifications and certifications are based on options and may vary.

## Optional Items

2 x 3.5" HDD drive bays bracket or 1 USB dongle kit

## Dimensions

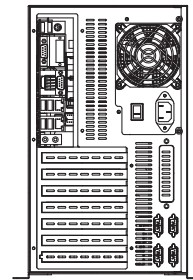
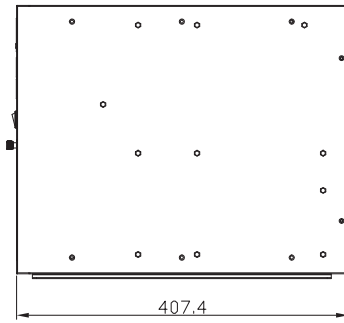
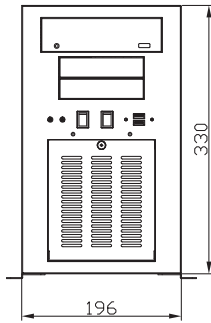
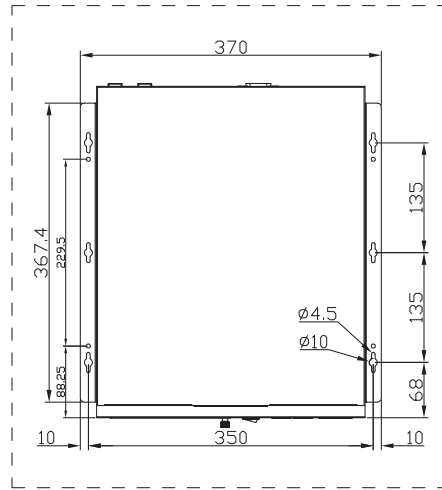
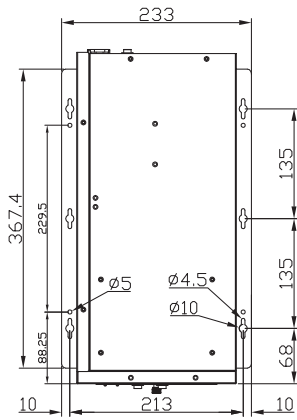

- 1
- 2
- 3
- 4
- 5
- 6
- 7

# AX61131TM

1U Cost-effective Rackmount Chassis for ATX Motherboard

## Features

- Supports 12" x 9.6" standard ATX MB (IMB206/IMB207/IMB208)
- Two 4 cm system fan
- Supports 1U Flex ATX power supply
- Internal two 3.5 HDD drive bays

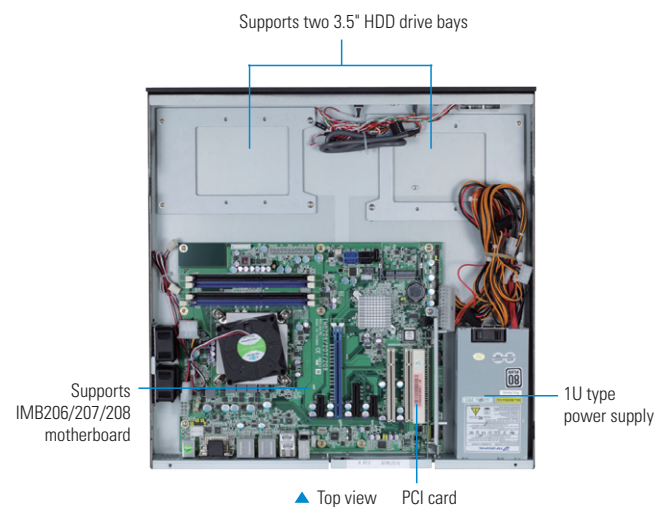

▲ Front view



▲ Rear view

## Specifications

Standard Color	Black
Construction	Heavy-duty steel
System Board	IMB206, IMB207, IMB208
Drive Capacity	Internal 2 x 3.5" HDD drive bay
Cooling	2 x 4 cm ball-bearing fan
Front Panel Indicators	1 x Power on/off 1 x HDD
Front Panel Controls	1 x Power on/off
Front Panel Connectors	2 x USB

Rear-Punched Panel	Rear 1 x 9-pin, 1 x 25-pin
Expansion Interface	1 x PCI slot (32 bits/33 MHz)
Operating Temperature	0°C to +40°C (+32°F to +104°F)
Dimensions	440 mm (17.3") (W) x 428 mm (16.8") (D) x 44 mm (1.73") (H)
Weight (net/gross)	9.8 kg (21.6 lb)/10.8 kg (23.81 lb)

## Ordering Information

AX61131TM/X270 1U rackmount chassis with ATX 270W power supply

\*Specifications and certifications are based on options and may vary.

## Packing List

AX61131TM chassis x 1  
CPU cooler x 1  
PCI riser card bracket x 1  
Screw pack x 1

## Recommended MB Selections

IMB206 with LGA1156 Heatsink (manufacture option)  
IMB207 with LGA1156 Heatsink (manufacture option)  
IMB208 with LGA1156 Heatsink (manufacture option)

## Optional Item

E296200100 AX96200-RC 1-slot 32-bit PCI riser card

## Dimensions

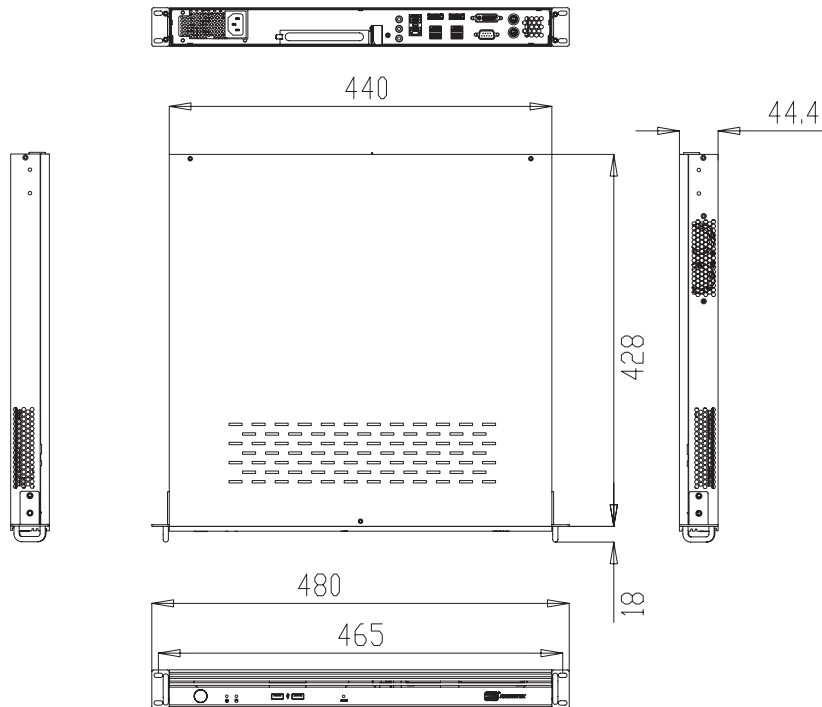

# AX61223TM NEW

2U Rackmount Chassis for ATX/Micro-ATX Motherboard

## Features

- Supports ATX/Micro-ATX motherboard
- Supports ATX power supply
- Internal one 3.5" HDD drive baysn Front-accessible one 3.5", one 5.25" and one slim CD-ROM

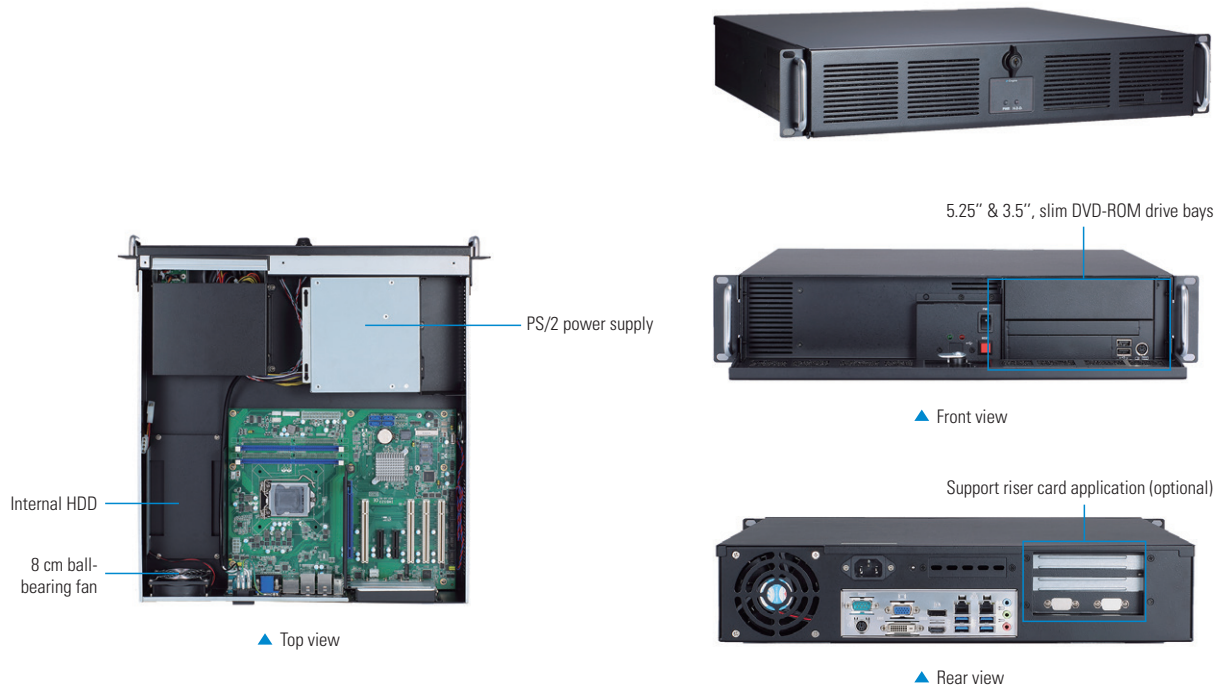

## Specifications

Standard Color	Black	
Construction	Heavy-duty steel	
System Board	ATX or mATX	
Drive Capacity	Exposed	1 x Slim-line CD-ROM bay 1 x 3.5" HDD drive bay 1 x 5.25" HDD drive bay
	Internal	1 x 3.5" HDD drive bay
Cooling	1 x 8 cm ball-bearing fan (38.6 CFM/each)	
Front Panel Indicators	1 x Power on/off 1 x HDD	
Front Panel Controls	1 x Power on/off 1 x System reset	

Front Panel Connectors	4 x USB 1 x PS/2
Rear plane	2 x COM opening 1 x flexible I/O opening
Expansion Interface	By riser card below (optional)
Speaker	1 x 0.3W speaker
Operating Temperature	0°C to +40°C (+32°F to +104°F)
RangeDimensions	482.6 mm (19") (W) x 450 mm (17.7") (D) x 88.9 mm (3.5") (H)
Weight (net/gross)	12 kg (26.45 lb)/13.5 kg (29.77 lb)



## Power Supply Specifications

Items	Watt	Input	Specifications		MTBF
			Output		
PS302-XP2	ATX 300W (PFC)	AC 100 to 240V (Auto)	+3.3V @ 19A	100,000 hours	
			+5V @ 16A		
			+12V1 @ 17A		
			+12V2 @ 17A		
PS400-XP2	ATX 400W (PFC)	AC 90 to 264V (Auto)	-12V @ 0.3A	100,000 hours	
			+5VSB @ 2.5A		
			+5V @ 20A		
			+12V1 @ 16A		
			+12V2 @ 16A		
			-12V @ 0.5A		
			+3.3V @ 20A		
PS500-XP2	ATX 500W (PFC)	AC 90 to 264V (Auto)	+5VSB @ 2.5A	100,000 hours	
			+5V @ 24A		
			+12V @ 34A		
			+12V1 @ 17A		
			+12V2 @ 17A		
			-12V @ 0.8A		
			+3.3V @ 24A		
+5VSB @ 2.5A					

## Ordering Information

AX61223TM/X300	2U rackmount chassis with ATX 300W power supply
AX61223TM/X400	2U rackmount chassis with ATX 400W power supply
AX61223TM/X500	2U rackmount chassis with ATX 500W power supply

\*Specifications and certifications are based on options and may vary.

## Optional Items

5A009672200E	PCIe x16 to one PCIe x 16 riser card
5A009672100E	PCIe x16 to two PCIe x 8 riser card
843LKF38410E	PCIe x1 to two PCI riser card

## Dimensions

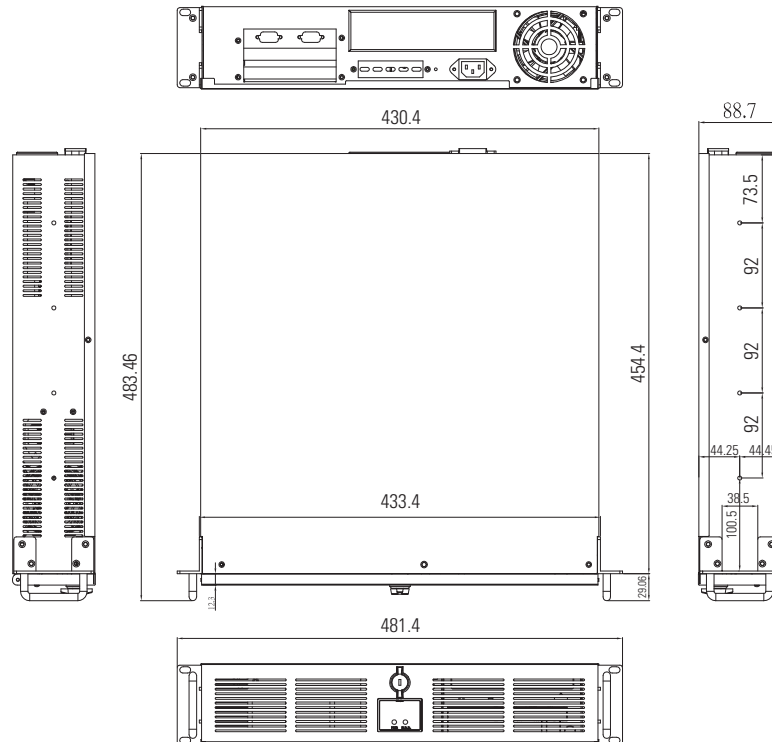

# AX61410 NEW

TP version: 4U 14-slot Rackmount Chassis for Full-size SHB/SBC series

TM version: 4U 7-slot Rackmount Chassis for ATX/Micro-ATX Motherboard

## Features

- Desktop or wallmount industrial computer chassis
- Three 5.25" HDD and one 3.5" HDD drive bays
- ATX or redundant power supply (optional)
- Lockable front door
- AX61410TP:
  - Supports 14-slot backplane
  - Desktop or wall mount industrial computer chassis
  - Three 5.25" HDD and one 3.5" HDD drive bays
  - ATX or redundant power supply (optional)
  - Lockable front door
- AX61410TM:
  - Supports ATX, micro-ATX MB
  - Desktop or wallmount industrial computer chassis
  - Three 5.25" HDD and one 3.5" HDD drive bays
  - ATX or redundant power supply (optional)
  - Lockable front door



▲ Front view

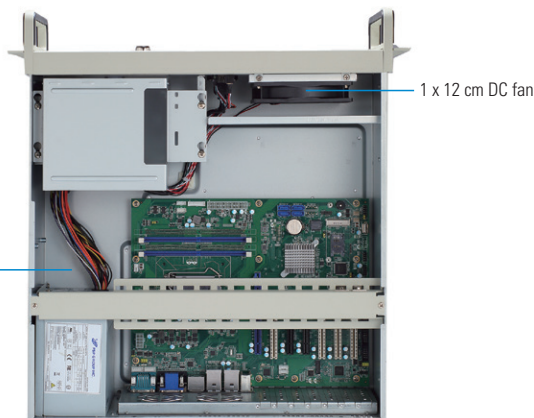

▲ Top view



▲ Rear view

## Specifications

Standard Color	Warm gray
Construction	Heavy-duty steel
System Board	TM version ATX or mATX TP version SBCs
Drive Capacity	Exposed 3 x 5.25" HDD drive bay 1 x 3.5" HDD drive bay Internal 1 x 3.5" HDD
Cooling	1 x 12 cm DC fan with a removable filter
Front Panel Indicators	1 x Power 1 x HDD
Front Panel Controls	1 x Power on/off 1 x System reset
Front Panel Connector	4 x USB

Operating Temperature	0°C to +40°C (+32°F to +104°F)
Dimensions	483mm (19.01") (W) x 480.9mm (18.93") (D) x 177mm (6.887") (H)
Weight (net/gross)	18 kg (39.68 lb)/19.5 kg (43 lb)
Speaker	Optional
Rear Panel	2 x COM opening, 2 x flexible I/O opening

## Ordering Information

AX61410TP	4U 14-slot rackmount chassis for full-size SBC
AX61410TM	4U 7-slot rackmount chassis for motherboard

\*Specifications and certifications are based on options and may vary.

# Dimensions

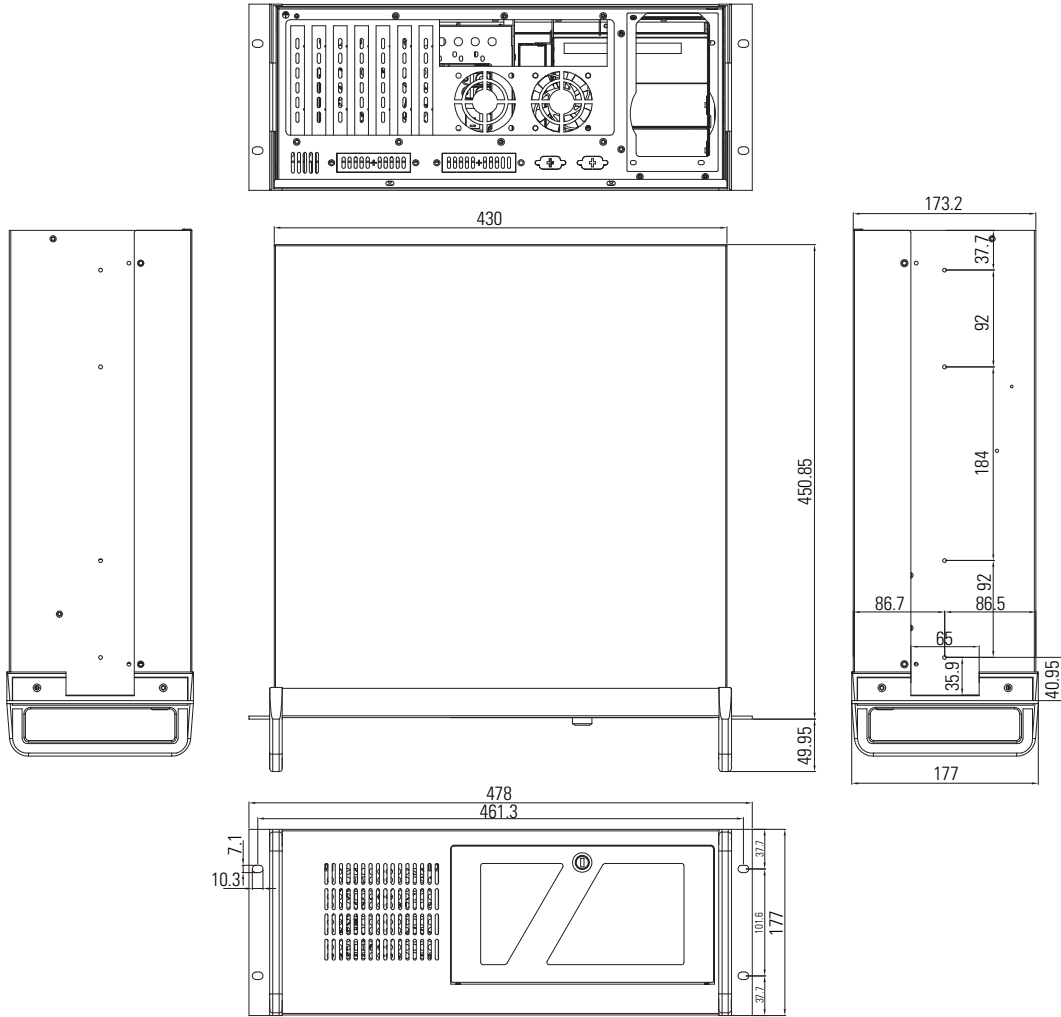

- 1
- 2
- 3
- 4
- 5
- 6
- 7

# AX6156LE

4U 14-slot Rackmount Chassis

## Features

- Three 5.25" and one 3.5" HDD drive bays
- One 12 cm ball-bearing fan (optional two 12 cm fans)
- Supports 14-slot backplane or ATX motherboard
- Hot-swap redundant power supply supported

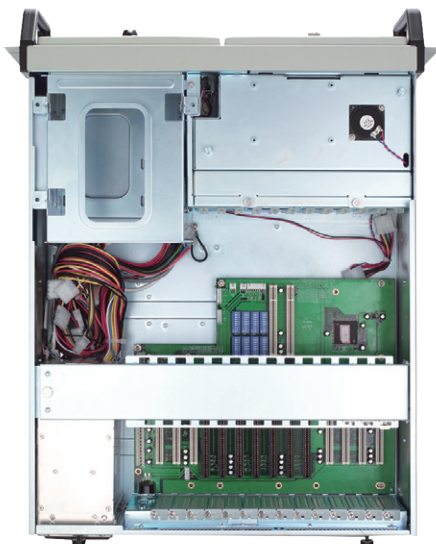

▲ Top view



## Specifications

Standard Color	Beige
Construction	Heavy-duty steel
Drive Capacity	Exposed 3 x 5.25" HDD drive bay 1 x 3.5" HDD drive bay
Cooling	1 x 12 cm ball-bearing fan (88 CFM/each) with a removable filter (optional two fans) Front Panel Indicators 1 x power on/off; 1 x HDD
Front Panel Controls	1 x Power on/off 1 x System reset
Front Panel Connectors	1 x USB 1x PS/2 5-pin keyboard

Pre-punched Panel	2 x 9-pin; 1 x DIN 5-pin keyboard
System Board	SBCs, ATX MB or IMB series
Expansion Interface	14-slot backplane
Speaker	1 x 0.3W speaker
Operating Temperature	0°C to +40°C (+32°F to +104°F)
Dimensions	484.7 mm (19") (W) x 537.6 mm (21.2") (D) x 176.7 mm (7") (H)
Weight (net/gross)	18 kg (39.68 lb)/19.5 kg (43 lb)

## Power Supply Specifications

Items	Watt	Input	Specifications		MTBF
			Output		
PS302-XP2	ATX 300W (PFC)	AC 100 to 240V (Auto)	+5V @ 16A	100,000 hours	
			+12V1 @ 17A		
RPS400-HRP	ATX 400W HRP (PFC)	AC 90 to 264V (Auto)	+12V2 @ 17A	100,000 hours	
			+3.3V @ 19A		
PS400-XP2	ATX 400W (PFC)	AC 90 to 264V (Auto)	+5VSB @ 2.5A	100,000 hours	
			-12V @ 0.3A		
PS501-HRP	ATX 500W HRP (PFC)	AC 90 to 264V (Auto)	+5V @ 35A	100,000 hours	
			+12V @ 28A		
PS400-XP2	ATX 400W (PFC)	AC 90 to 264V (Auto)	-5V @ 0.5A	100,000 hours	
			+3.3V @ 25A		
PS501-HRP	ATX 500W HRP (PFC)	AC 90 to 264V (Auto)	+5VSB @ 2.0A	100,000 hours	
			+5V @ 25A		
PS400-XP2	ATX 400W (PFC)	AC 90 to 264V (Auto)	+12 @ 41A	100,000 hours	
			-12V @ 0.8A		
PS501-HRP	ATX 500W HRP (PFC)	AC 90 to 264V (Auto)	+3.3V @ 25A	100,000 hours	
			+5VSB @ 3.5A		

## Ordering Information

AX6156LET(W)B/X300	14-slot version, with ATX 300W power supply
AX6156LET(W)B/X400	14-slot version, with ATX 400W power supply
AX6156LET(W)B/X300R	14-slot version, with ATX 300W redundant power supply
AX6156LET(W)M/X300	MB version, with ATX 300W power supply
AX6156LET(W)M/X400	MB version, with ATX 400W power supply
AX6156LET(W)M/X300R	MB version, with ATX 300W redundant power supply

\*Specifications and certifications are based on options and may vary.

\*\* T-Black color; W-Beige color

## Dimensions

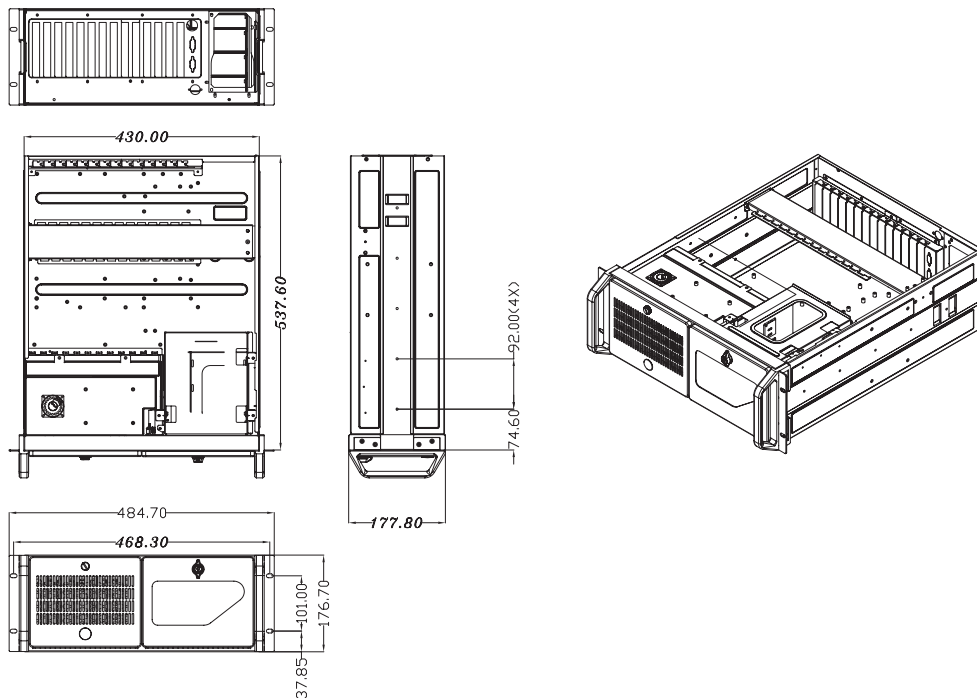

## Backplane Options

### PICMG 1.0

Models	Slots per Segment (ISA/PCI/PCle/CPU)	Segment
ATX6022/13L	8/4/0/1	Single
ATX6022/14	9/4/0/1	Single
ATX6022/14G	1/12/0/1	Single
ATX6022/14GP7	6/7/0/1	Single

### PICMG 1.3

Models	Slots per Segment (ISA/PCI/PCle/CPU)	Segment
FAB100	4/4/5/1	Single
FAB101	0/13/0/1	Single
FAB112	0/10/2/1	Single
FAB113	0/4/8/1	Single
FAB114	0/8/4/1	Single
FAB118	0/7/6/1	Single
FAB119	0/10/2/1	Single

## Optional Items

ATX 500W power supply with PFC

ATX 300W redundant power supply with PFC

ATX 500W redundant power supply with PFC





# Table of Contents

## Industrial Panel PCs

### 1 Fanless Touch Panel Computers

---

Selection Guide		245
<b>NEW</b> GOT107W-319	7" WSVGA TFT Fanless Touch Panel Computer with Intel® Celeron® Processor N3350	247
GOT110-316	10.4" XGA TFT Fanless Touch Panel Computer with Intel® Celeron® Processor N3350	249
<b>NEW</b> GOT115-319	15" XGA TFT Fanless Touch Panel Computer with Intel® Celeron® Processor N3350	251
GOT5103W-845	10.1" WXGA TFT Fanless Touch Panel Computer with Intel® Celeron® Processor N3060	253
GOT5153W-845	15.6" WXGA TFT Fanless Touch Panel Computer with Intel® Celeron® Processor N3060	255

### 2 Heavy-duty Fanless Touch Panel Computers

---

Selection Guide		259
<b>NEW</b> GOT315WL-845-PCT	15.6" WXGA TFT Multi-touch Panel Computer with Intel® Pentium® Processor N3710	261
GOT317-502-FR	17" SXGA TFT Expandable Touch Panel Computer with 7th/6th Gen Intel® Core™ i7/i5/i3 Processor	263
GOT3177T-311-FR	17" SXGA TFT Flat Bezel Expandable Touch Panel Computer with Intel® Pentium® Processor N4200	265
<b>NEW</b> GOT318WL-845-PCT	18.5" WXGA TFT Multi-touch Panel Computer with Intel® Pentium® Processor N3710	267
GOT321W-502-PCT	21.5" FHD TFT Multi-touch Panel Computer with 7th/6th Gen Intel® Core™ i7/i5/i3 Processor	269
GOT3217WL-845-PCT	21.5" FHD TFT Multi-touch Panel Computer with Intel® Pentium® Processor N3710	271

### 3 Vehicle Mount Terminal Computer

---

Selection Guide		274
GOT610-837	10.4" XGA Fanless Touch Panel PC with Intel® Atom® Processor E3845 1.91 GHz for Heavy-duty Vehicle [-30°C to +55°C]	275

## 4 Stainless Touch Panel Computers

---

Selection Guide		279
GOT812L(H)-880	12.1" XGA TFT IP66 & IP69K-rated Stainless Steel Fanless PCT (or Resistive Touch) Panel Computer with Intel® Core™ i5 Processor and Flat Bezel Design (-20°C to +50°C)	281
GOT812LR-834	12.1" XGA TFT IP66-rated Stainless Steel Fanless Touch Panel Computer with Intel® Atom® Processor E3827 and High Brightness (-20°C to +55°C)	283
GOT815L-511	15" XGA TFT IP66 & IP69K-rated Stainless Steel Fanless PCT (or Resistive Touch) Panel Computer with Intel® Core™ i5-7300U Processor and Flat Bezel Design (-20°C to +50°C)	285
GOT815-834	15" XGA TFT IP66 & IP69K-rated Stainless Steel Fanless PCT (or Resistive Touch) Panel Computer with Intel® Atom® Processor E3827 and Flat Bezel Design (-20°C to +55°C)	287
GOT817L-511	17" SXGA TFT IP66 & IP69K-rated Stainless Steel Fanless PCT (or Resistive Touch) Panel Computer with Intel® Core™ i5-7300U Processor and Flat Bezel Design (-20°C to +50°C)	289
GOT817-834	17" SXGA TFT IP66 & IP69K-rated Stainless Steel Fanless PCT (or Resistive Touch) Panel Computer with Intel® Atom® Processor E3827 and Flat Bezel Design (-20°C to +55°C)	291

## 5 Transportation Touch Panel Computers & Displays

---

Selection Guide		295
GOT710-837	10.4" SVGA TFT EN 50155 Railway Fanless Touch Panel PC with Intel® Atom® Processor E3845 1.91 GHz (-25°C to +70°C)	297
GOT712-837	12.1" XGA TFT EN 50155 Railway Fanless Touch Panel PC with Intel® Atom® Processor E3845 1.91 GHz (-25°C to +70°C)	299
P6105	10.4" XGA TFT EN 50155 Railway Touch Display (-25°C to +55°C)	301
 P6125	12.1" XGA TFT EN 50155 Railway Touch Display (-25°C to +55°C)	303

## 6 Industrial Touch Panel Computers

---

Selection Guide		307
P1127E-500	12.1" XGA TFT Expandable Industrial Touch Panel Computer with 7th/6th Gen Intel® Core™ i7/i5/i3, Celeron® & Pentium® Processor and PCI/PCIe Slot	309
P1157E-500	15" XGA TFT Expandable Industrial Touch Panel Computer with 7th/6th Gen Intel® Core™ i7/i5/i3, Celeron® & Pentium® Processor and PCI/PCIe Slot	311
P1177E-500	17" SXGA TFT Expandable Industrial Touch Panel Computer with 7th/6th Gen Intel® Core™ i7/i5/i3, Celeron® & Pentium® Processor and PCI/PCIe Slot	313
P1197E-500	19" SXGA TFT Expandable Industrial Touch Panel Computer with 7th/6th Gen Intel® Core™ i7/i5/i3, Celeron® & Pentium® Processor, PCI/PCIe Slot	315

## 7 Industrial Touch Monitors

---

Selection Guide		319
P6157W-V2	15.6" WXGA TFT Widescreen Industrial LCD Monitor	321
P6171-V2	17" SXGA TFT Industrial LCD Monitor	323
P6187W-V2	18.5" WXGA TFT Widescreen Industrial LCD Monitor	325
P6217W	21.5" FHD TFT Widescreen Industrial LCD Monitor	327

## 8 Medical Panel Computers

---

Selection Guide		331
MPC103-845	10.1" WXGA TFT Fanless Medical Grade Touch Panel Computer with Intel® Celeron® Processor N3060	333
MPC102-845	10.4" XGA TFT Fanless Medical Grade Touch Panel Computer with Intel® Celeron® Processor N3060	335
MPC152-845	15" XGA TFT Fanless Medical Grade Touch Panel Computer with Intel® Celeron® Processor N3060	337
MPC153-834	15.6" WXGA TFT Fanless Medical Grade Touch Panel Computer with Intel® Celeron® Processor J1900	339
MPC240	24" FHD TFT Medical Grade Panel Computer with 4th Gen Intel® Core™ i7/i5/i3, Celeron® & Pentium® Mobile Processor	341

## 9 Open Frame Panel Computer

---

Selection Guide		344
FDK172-834	17" SXGA TFT Open Frame Panel Computer with Intel® Celeron® Processor J1900	345



Fanless Touch Panel Computers

Heavy-duty Fanless Touch Panel Computers

Vehicle Mount Terminal Computer

Stainless Touch Panel Computers

Transportation Touch Panel Computers and Displays

Industrial Touch Panel Computers

Industrial Touch Monitors

Medical Panel Computers

Open Frame Panel Computer

# Industrial Panel PCs

# 1

## Fanless Touch Panel Computers

The GOT100/GOT5000 series features fanless operation, ultra slim and modern ID design. Incorporating the low power consumption Intel® Celeron® processors and an ultra slim housing makes this product line a perfect choice for various applications across many industries.

	Selection Guide	245	
	GOT107W-319	7" WSVGA TFT Fanless Touch Panel Computer with Intel® Celeron® Processor N3350	247
	GOT110-316	10.4" XGA TFT Fanless Touch Panel Computer with Intel® Celeron® Processor N3350	249
	GOT115-319	15" XGA TFT Fanless Touch Panel Computer with Intel® Celeron® Processor N3350	251
	GOT5103W-845	10.1" WXGA TFT Fanless Touch Panel Computer with Intel® Celeron® Processor N3060	253
	GOT5153W-845	15.6" WXGA TFT Fanless Touch Panel Computer with Intel® Celeron® Processor N3060	255

# Fanless Touch Panel Computers

## Selection Guide

NEW



NEW

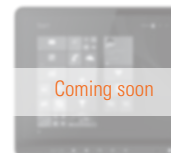

Features/Models	GOT107W-319	GOT110-316	GOT115-319
<b>CPU Level</b>	Intel® Celeron® Processor N3350, 2C@1.1GHz, TDP 6W (default)	Intel® Celeron® N3350, 2C @ 1.1 GHz, TDP 6W	Intel® Celeron® Processor N3350, 2C@1.1GHz, TDP 6W (default)
<b>Chipset</b>	SoC integrated	SoC integrated	SoC integrated
<b>System Memory</b>	1 x SO-DIMM 204-pin DDR3L, up to 8GB	1 x 204-pin DDR3L SO-DIMM socket, up to 8GB	1 x SO-DIMM 204-pin DDR3L, up to 8GB
<b>Display</b>	7" WSVGA TFT LCD, 320 nits	10.4" XGA TFT, 350 nits	15" XGA TFT LCD, 300 nits
<b>I/O</b>	1 x RS-232/422/485 1 x RS-232 2 x 10/100/1000 Mbps Ethernet 2 x USB 3.0 1 x Screw type connector for power 1 x Power switch 1 x Line-out	1 x RS-232/422/485 1 x RS-232 2 x 10/100/1000 Mbps Ethernet (PoE PD optional) 4 x USB 3.0 1 x Screw type connector for power 1 x Power button (ATX) 1 x Remote power switch 1 x Line-out 1 x ATX/AT selectable switch 1 x HDMI	1 x RS-232/422/485 1 x RS-232 2 x 10/100/1000 Mbps Ethernet (PoE PD optional) 2 x USB 3.0 2 x USB 2.0 1 x Screw type connector for power 1 x Power button (ATX) 1 x Remote power switch 1 x Line-out 1 x ATX/AT selectable switch
<b>Storage</b>	1 x mSATA 1 x MicroSD Card	1 x 2.5" SATA HDD 1 x mSATA	1 x 2.5" SATA HDD 1 x mSATA
<b>Expansion Interface</b>	1 x PCI Express Mini Card slot 1 x M.2 Key E	2 x PCI Express Mini Card slot	1 x PCI Express Mini Card slot 1 x M.2 Key E
<b>Touchscreen</b>	Projected capacitive multi-touch	5-wire resistive touch	5-wire resistive touch or Projected capacitive multi-touch
<b>Operating System</b>	Windows® 10 (64-bit)	Windows® 10 (64-bit)	Windows® 10 (64-bit)
<b>Power Supply</b>	100 to 240 VAC, 60W power adapter or DC cable for 24 VDC	DC version: 12/19 to 24 VDC adapter cable AC version: 100 to 240V AC-DC, 60W power adapter	100 to 240 VAC, 60W power adapter or DC cable for 24 VDC
<b>Power Consumption</b>	TBD	24W	TBD
<b>Watchdog Timer</b>	255 levels, 0 to 255 sec.	255 levels, 0 to 255 sec.	255 levels, 0 to 255 sec.
<b>Dimensions (W x D x H)</b>	TBD	259.43 x 43.5 x 232.73 mm (10.21" x 1.71" x 9.16")	TBD
<b>Weight (net/gross)</b>	TBD	1.8 kg (3.96 lb)/3 kg (6.61 lb)	TBD
<b>Operating Temperature</b>	0°C to +50°C (+32°F to +122°F)	0°C to +50°C (+32°F to +122°F)	0°C to +50°C (+32°F to +122°F)
<b>Certifications</b>	CE, FCC	CE, FCC	CE, FCC





Features/Models	GOT5103W-845	GOT5153W-845
<b>CPU Level</b>	Intel® Celeron® N3060 up to 2.48 GHz	Intel® Celeron® N3060 up to 2.48 GHz
<b>Chipset</b>	SoC integrated	SoC integrated
<b>System Memory</b>	1 x 204-pin DDR3L-1600 SO-DIMM, up to 8GB	1 x 204-pin DDR3L-1600 SO-DIMM, up to 8GB
<b>Display</b>	10.1" WXGA TFT, 350 nits	15.6" WXGA TFT, 300 nits
<b>I/O</b>	1 x RS-232 1 x RS-232/422/485 2 x 10/100/1000 Mbps Ethernet 2 x USB 2.0 2 x USB 3.0 1 x Audio (Line-out) 1 x HDMI 1 x Switch for power on/off 1 x AT/ATX mode selection switch	1 x RS-232 1 x RS-232/422/485 2 x 10/100/1000 Mbps Ethernet 2 x USB 2.0 2 x USB 3.0 1 x Audio (Line-out) 1 x HDMI 1 x Switch for power on/off 1 x AT/ATX mode selection switch
<b>Storage</b>	1 x Half-slim SATA SSD (optional) 1 x mSATA	1 x mSATA 1 x 2.5" SATA HDD (AC version only)
<b>Expansion Interface</b>	2 x PCI Express Mini Card slot	2 x PCI Express Mini Card slot
<b>Touchscreen</b>	Projected capacitive multi-touch	Projected capacitive multi-touch 5-wire flat resistive type
<b>Operating System</b>	Windows® 10, Windows® 8.1, WE8S, Windows® 7, WES 7	Windows® 10, Windows® 8.1, WE8S, Windows® 7, WES 7
<b>Power Supply</b>	24 VDC 100 to 240 VAC, 60W power adapter	DC version: 9 to 36 VDC with over-current protection fuse AC version: 100 to 240 VAC-DC, 60W power adapter
<b>Power Consumption</b>	40.32W	30W
<b>Watchdog Timer</b>	255 levels, 0 to 255 sec.	255 levels, 0 to 255 sec.
<b>Dimensions (W x D x H)</b>	260.8 x 38 x 194.1 mm (10.27" x 1.50" x 7.65")	394.2 x 57 x 257.2 mm (15.53" x 2.25" x 10.13")
<b>Weight (net/gross)</b>	1.08 kg (2.38 lb)/2.18 kg (4.8 lb)	3.0 kg (6.61 lb)/4.5 kg (9.92 lb)
<b>Operating Temperature</b>	0°C to +50°C (+32°F to +122°F)	0°C to +50°C (+32°F to +122°F)
<b>Certifications</b>	CE, FCC	CE, FCC

# GOT107W-319 NEW

7" WSVGA TFT Fanless Touch Panel Computer with Intel® Celeron® Processor N3350

## Features

- 7" WSVGA TFT LCD display with LED backlight
- Fanless design with Intel® Celeron® processor N3350
- 2 GbE LANs, 2 USB and 2 COM
- Plastic and IP65-rated front bezel
- Supports RFID (optional)
- External AT/ATX mode selection switch
- Easy access storage design
- Supports panel mount, wall mount, VESA arm and desktop stand



▲ Side view



▲ Rear view



## Introduction

The GOT107W-319 is a 7" fanless touch panel computer. In response to market demand, this panel computer is a cost effective solution. It adopts a modern, super sleek and fanless design and is equipped with the Intel® Celeron® processor N3350 up to 2.40 GHz. For wireless network connection, the GOT107W-319 offers one PCI Express Mini Card slot and one M.2 Key E for wireless module. By just plugging in the WLAN card, customers can have instant access to wireless LAN/GPRS/GSM/4G environments.

### Super Slim Design

The GOT107W-319 is a super slim touch panel computer for space-limited applications.

### Support Front Membrane Keys

The GOT107W-319 has 5 membrane keys on the front panel which allows users to adjust the LCD on/off, LCD brightness and volume setting easily.

### Aluminum Back Chassis with Excellent Thermal Solution

With Axiomtek's patent for plastic plus aluminum mechanism design, the GOT107W-319 can dissipate the heat easily and keep the system operation stable.

## Specifications

Front Bezel	IP65, NEMA 4 rugged protection, plastic front bezel	
LCD Panel	Display Type	7" WSVGA TFT LCD with LED backlight
	Brightness (cd/m <sup>2</sup> )	320 nits
	Resolution	1024 x 600
	Viewing Angel (H/V)	145°/150°
Main System	CPU	Intel® Celeron® processor N3350 2 cores (up to 2.40 GHz)
	System Memory	1 x 204-pin DDR3L-1600 SO-DIMM, up to 8GB
	BIOS	AMI UEFI BIOS
	Storage	1 x mSATA 1 x MicroSD card
	Watchdog Timer	255 levels, 0 to 255 sec.
	Onboard Graphics	Integrated in Intel® GFX

## Specifications

I/O Connector	1 x RS-232/422/485 1 x RS-232 2 x 10/100/1000 Mbps Ethernet 2 x USB 3.0 1 x Screw type connector for power 1 x Power switch 1 x Line-out
Expansion Interface	1 x M.2 KEY E for wireless module 1 x Full-size PCI Express Mini Card slot with SIM
Touchscreen	Projected capacitive multi-touch
Power Supply	DC version: 12/19 to 24 VDC adapter cable AC version: 100 to 240 VAC-DC, 60W power adapter
Power Consumption	TBC
Dimensions	TBC
Packing Dimensions	TBC
Weight (net/gross)	TBC
Operating Temperature	0°C to +50°C (+32°F to +122°F)
Relative Humidity	20% to 90% @ +40°C; non-condensing
Operation Vibration	2G, 5 to 500Hz, random for SSD
Certifications	CE, FCC class B

## Ordering Information

Standard	
GOT107W-319	7" WSVGA fanless touch panel computer with Intel® Celeron® processor N3350, projected capacitive multi-touch and AC-DC 60W power adapter (screw type connector)

## Optional Accessories

Wi-Fi + Bluetooth kit
Panel mount kit
Wall mount kit
Stand kit
RFID kit

\* Specifications and certifications may vary based on different requirements.

## Optional OS Installation

Windows® 10
-------------



# GOT110-316 NEW

10.4" XGA TFT Fanless Touch Panel Computer with Intel® Celeron® Processor N3350

## Features

- 10.4" XGA TFT LCD display with LED backlight
- Fanless design with Intel® Celeron® processor N3350
- 2 GbE LANs, 4 USB and 2 COM
- IP65-rated front bezel and IPX1 rated back cover
- Peripheral support including MSR, RFID, Wi-Fi, barcode scanner
- External AT/ATX mode selection switch
- Easy maintenance design for storage and memory
- Supports panel mount, wall mount, VESA arm and desktop stand
- Adjustable RS-232/422/485 setting via BIOS
- Aluminum cover for the better thermal dissipation and reliability



1. Power LED
2. HDD LED
3. Brightness adjust +/-
4. Display on/off
5. Volume on/off



▲ Side view

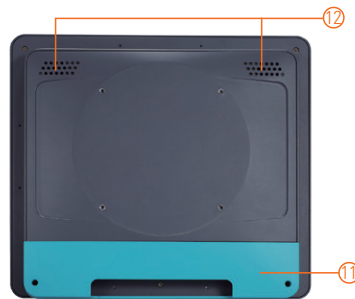

▲ Rear view

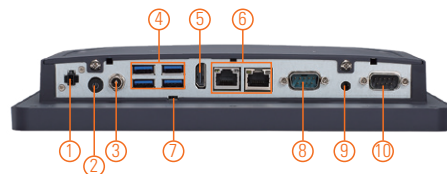

1. Remote power switch
2. Power button
3. Screw connector for adapter
4. 4 x USB 3.0
5. 1 x HDMI
6. 2 x LAN
7. AT/ATX switch
8. 1 x RS-232/422/485
9. Audio (Line-out)
10. 1 x RS-232
11. Cable cover (optional)
12. Speaker



## Introduction

The GOT110-316 is a 10.4" fanless touch panel computer. In response to market demand, this panel computer is a cost effective solution. It adopts a modern, super sleek and fanless design and is equipped with the Intel® Celeron® processor N3350 dual core up to 2.40 GHz. For wireless network connection, the GOT110-316 offers two PCI Express Mini Card slots. By just plugging in the WLAN card, customers can have instant access to wireless LAN. Besides, it can be integrated with peripheral devices including barcode scanner, RFID, MSR, Wi-Fi, and Bluetooth.

### Super Slim Design

With a thickness of 41.5 mm, the GOT110-316 is a super slim touch panel computer for space-limited environment.

### Optional PoE Solution

GOT110-316 provides PoE solution which provides data and power to the system. This infrastructure allows to centralized power management; therefore, it is a cost-effective solution for access control, home and industrial automation.

### Aluminum Back Chassis with Excellent Thermal Solution

With Axiomtek's patent for plastic plus aluminum mechanism design, the GOT110-316 can dissipate the heat easily and keep the system operation stable.

## Specifications

Front Bezel	IP65, NEMA 4 rugged protection, plastic front bezel	
LCD Panel	Display Type	10.4" XGA TFT LCD with LED backlight
	Brightness (cd/m <sup>2</sup> )	350 nits (XGA)
	Resolution	1024 x 768
	Viewing Angel (H/V)	160°/160°
Main System	CPU	Intel® Celeron® processor N3350 2 cores (up to 2.40 GHz)
	System Memory	1 x 204-pin DDR3L-1600 SO-DIMM, up to 8GB
	BIOS	AMI UEFI BIOS
	Storage	1 x 2.5" SATA HDD (9.5 mm height) 1 x mSATA
	Watchdog Timer	255 levels, 0 to 255 sec.
	Onboard Graphics	Integrated in Intel® GFX

## Specifications

I/O Connector	1 x RS-232/422/485 (default RS-232) 1 x RS-232 2 x 10/100/1000 Mbps Ethernet (PoE PD optional) 4 x USB 3.0 1 x Screw type connector for power 1 x Power button (ATX) 1 x Remote power switch 1 x Line-out 1 x ATX/AT selectable switch 1 x HDMI
Expansion Interface	1 x Full-size PCI Express Mini Card slot with mSATA 1 x Full-size PCI Express Mini Card slot with SIM
Touchscreen	Projected capacitive multi-touch 5-wire flat resistive touch
Power Supply	DC version: 12/19 to 24 VDC adapter cable AC version: 100 to 240 VAC-DC, 60W power adapter
Power Consumption	24W
Dimensions	259.43 mm (10.21") (W) x 43.5 mm (1.71") (D) x 232.73 mm (9.16") (H)
Packing Dimensions	415 mm (16.34") (W) x 100 mm (3.94") (D) x 315 mm (12.4") (H)
Weight (net/gross)	1.8 kg (3.96 lb)/3 kg (6.61 lb)
Operating Temperature	0°C to +50°C (+32°F to +122°F)
Relative Humidity	20% to 90% @ +40°C; non-condensing
Operation Vibration	2G, 5 - 500Hz, random for SSD
Certifications	CE, FCC

## Packing List

- 1 x GOT110-316
- 1 x Driver DVD
- 1 x Adapter (GOT110-316-J)
- 1 x DC cable (GOT110-316-DC)

## Ordering Information

Standard	
GOT110-316-J	10.4" XGA fanless touch panel computer with Intel® Celeron® processor N3350, 5-wire flat resistive touch AC-DC 60W power adapter and EMI Class A (screw type connector)
GOT110-316-DC	10.4" XGA fanless touch panel computer with Intel® Celeron® processor N3350, resistive touch and logo, and screw type power input with DC cable

## Optional Accessories

- Wi-Fi + Bluetooth kit
- Panel mount kit
- Wall mount kit
- Stand kit
- RFID kit
- MSR card reader kit
- Barcode scanner kit
- DC cable
- PoE PD card

\* Specifications and certifications may vary based on different requirements.

## Optional OS Installation

Windows® 10



## Dimensions

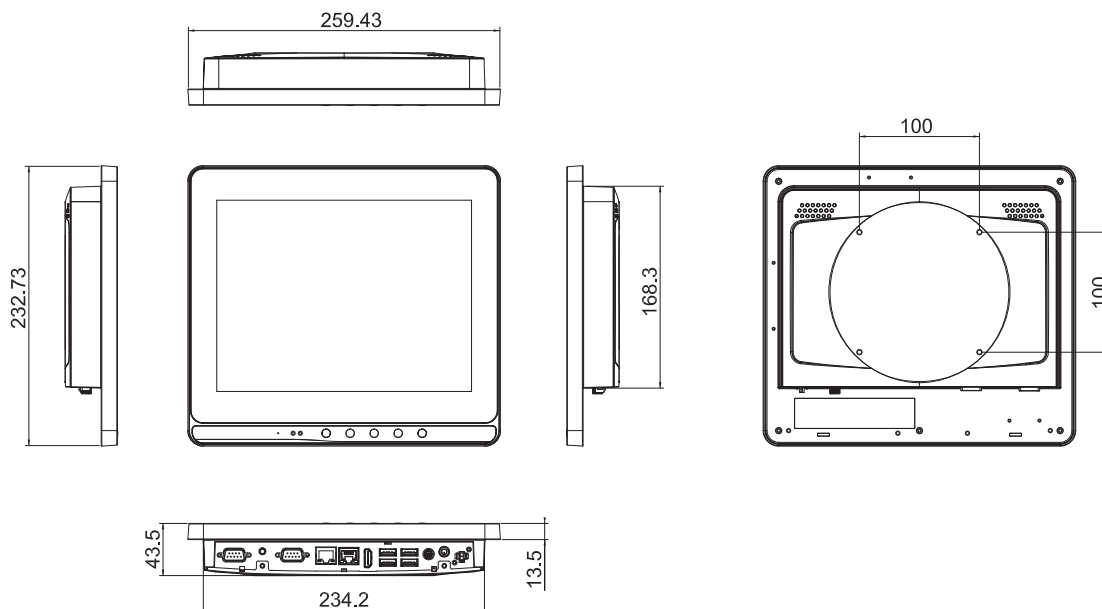

# GOT115-319 NEW

15" XGA TFT Fanless Touch Panel Computer with Intel® Celeron® Processor N3350

## Features

- 15" XGA TFT LCD display with LED backlight
- Fanless design with Intel® Celeron® processor N3350
- 2 GbE LANs, 4 USB and 2 COM
- Plastic and IP65-rated front bezel
- Supports RFID (optional)
- External AT/ATX mode selection switch
- Easy access storage design
- Supports panel mount, wall mount, VESA arm and desktop stand
- Adjustable RS-232/422/485 setting and 5V/12V powered COM via BIOS
- Supports PoE card (optional)



## Introduction

The GOT115-319 is a 15" fanless touch panel computer. In response to market demand, this panel computer is a cost effective solution. It adopts a modern, super sleek and fanless design and is equipped with the Intel® Celeron® processor N3350 up to 2.40 GHz. For wireless network connection, the GOT115-319 offers two PCI Express Mini Card slots. By just plugging in the WLAN card, customers can have instant access to wireless LAN/GPRS/GSM/4G environments. Besides, it can be integrated with peripheral devices including barcode scanner, RFID, MSR, Wi-Fi, Bluetooth and smart card reader.

### Super Slim Design

With a thickness of 43 mm, the GOT115-319 is a super slim touch panel computer for space-limited environment.

### Optional PoE Solution

GOT115-319 provide PoE solution which make system operated with only one Ethernet cable that provide data and power to the system. This infrastructure allows to centralized power management, therefore it is a cost-effective solution for access control, home and industrial automation.

### Aluminum Back Chassis with Excellent Thermal Solution

With Axiomtek's patent for plastic plus aluminum mechanism design, the GOT115-319 can dissipate the heat easily and keep the system operation stable.

## Specifications

Front Bezel	IP65, NEMA 4 rugged protection, plastic front bezel	
LCD Panel	Display Type	15" XGA TFT LCD with LED backlight
	Brightness (cd/m <sup>2</sup> )	420 nits (XGA)
	Resolution	1024 x 768
	Viewing Angel (H/V)	140°/100°
Main System	CPU	Intel® Celeron® processor N3350 2 cores (up to 2.40 GHz)
	System Memory	1 x 204-pin DDR3L-1600 SO-DIMM, up to 8GB
	BIOS	AMI UEFI BIOS
	Storage	1 x 2.5" SATA HDD (9.5 mm height) 1 x mSATA
	Watchdog Timer	255 levels, 0 to 255 sec.
	Onboard Graphics	Integrated in Intel® GFX



## Specifications

I/O Connector	1 x RS-232/422/485 (default RS-232) 1 x RS-232 2 x 10/100/1000 Mbps Ethernet (PoE PD optional) 4 x USB 3.0 1 x Screw type connector for power 1 x Power button (ATX) 1 x Remote power switch 1 x Line-out 1 x ATX/AT selectable switch
Expansion Interface	1 x Full-size PCI Express Mini Card slot with mSATA 1 x Full-size PCI Express Mini Card slot with SIM
Touchscreen	Projected capacitive multi-touch 5-wire flat resistive touch
Power Supply	DC version: 12/19 to 24 VDC adapter cable AC version: 100 to 240 VAC-DC, 60W power adapter
Power Consumption	TBC
Dimensions	TBC
Packing Dimensions	TBC
Weight (net/gross)	TBC
Operating Temperature	0°C to +50°C (+32°F to +122°F)
Relative Humidity	20% to 90% @ +40°C; non-condensing
Operation Vibration	2G, 5 to 500Hz, random for SSD
Certifications	CE

## Ordering Information

Standard	
GOT115-319	15" XGA fanless touch panel computer with Intel® Celeron® processor N3350, 5-wire flat resistive touch and AC-DC 60W power adapter (screw type connector)

## Optional Accessories

Wi-Fi + Bluetooth kit
Panel mount kit
Wall mount kit
Stand kit
RFID kit

\* Specifications and certifications may vary based on different requirements.

## Optional OS Installation

Windows® 10
-------------



# GOT5103W-845

10.1" WXGA TFT Fanless Touch Panel Computer with Intel® Celeron® Processor N3060

## Features

- 10.1" WXGA wide screen TFT LCD display with LED backlight
- Projected capacitive multi-touch
- Fanless design with Intel® Celeron® processor N3060 (up to 2.48 GHz)
- 1 mSATA and 1 half-slim SATA SSD (optional)
- 2 GbE LAN, 4 USB, 2 COM, 2W speakers and optional Mic-in
- IP65-rated front bezel and IPX1 full enclosure design
- Supports panel mount, wall mount, VESA arm and desktop stand
- External AT/ATX mode selection switch



## Introduction

The GOT5103W-845 is a 10.1" fanless touch panel computer. In response to market demand, this panel computer is a cost effective solution. It adopts a modern, sleek and fanless design and is equipped with the Intel® Celeron® processor N3060 up to 2.48 GHz. For wireless network connection, the GOT5103W-845 offers two PCI Express Mini Card slots. By just installing a WLAN card and antennas, customers can have instant access to wireless LAN/GPRS/GSM/4G environments. Besides, it provides two types of power input: DC power with terminal block connector and AC power adapter with screw type connector.

### Slim & Lightweight Design

The GOT5103W-845 is slim and lightweight which make it fit for limited space installation.

### Optional Internal WLAN Antenna

The GOT5103W-845 provides two PCI Express Mini Card slots and optional internal WLAN antennas for wireless network connections. Customers can use the GOT5103W-845 in wireless LAN/GPRS/GPS/4G environment.

### Support Front Membrane Keys (optional)

The GOT5103W-845 has 5 membrane keys on the front panel which allows users to adjust the LCD on/off, LCD brightness and volume setting easily.

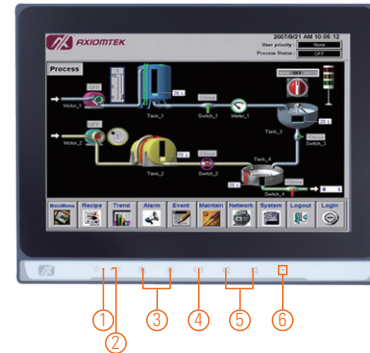

1. Power LED
2. HDD LED
3. Brightness adjust +/- (optional)
4. Display on/off (optional)
5. Volume adjust (optional)
6. Mic-in (optional)

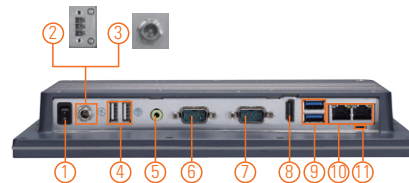

1. Power switch (ATX)
2. Terminal block for DC power input
3. Screw connector for AC power adapter
4. 2 x USB 2.0
5. Audio (Line-out)
6. 1 x RS-232/422/485
7. 1 x RS-232
8. 1 x HDMI
9. 2 x USB 3.0
10. 2 x LAN
11. AT/ATX switch
12. Speaker

## Specifications

Front Bezel	IP65, plastic front bezel	
LCD Panel	Display Type	10.1" WXGA TFT LCD with LED backlight
	Brightness (cd/m <sup>2</sup> )	350 nits
	Resolution	1280 x 800
Main System	CPU	Intel® Celeron® processor N3060 2 cores (up to 2.48 GHz)
	System Memory	1 x 204-pin DDR3L-1600 SO-DIMM, up to 8GB
	BIOS	AMI UEFI BIOS
	Storage	1 x Half-slim SATA SSD (for GOT5103W-845-PCT-J, optional) 1 x mSATA
	Watchdog Timer	255 levels, 0 to 255 sec.
	Onboard Graphics	Integrated Intel® HD GFX

## Specifications

I/O Connector	1 x RS-232 1 x RS-232/422/485 1 x HDMI 1 x Switch for power on/off 1 x AT/ATX mode selection switch 2 x USB 2.0 2 x USB 3.0 1 x Audio (Line-out) 2 x 10/100/1000 Mbps Ethernet (Intel® i211-AT)
TPM	N/A
Expansion Interface	1 x Full-size PCI Express Mini Card with mSATA 1 x Full-size PCI Express Mini Card with SIM
Touchscreen	Projected capacitive multi-touch
Power Supply	AC version: 100 to 240 VAC-DC, 60W power adapter or DC version: 24 VDC with over current protection fuse
Power Consumption	40.32W
Dimensions	260.8 mm (10.27") (W) x 38 mm (1.50") (D) x 194.1 mm (7.65") (H)
Packing Dimensions	380 mm (14.96") (W) x 100 mm (3.94") (D) x 280 mm (11.02") (H)
Weight (net/gross)	1.08 kg (2.38 lb)/2.18 kg (4.8 lb)
Operating Temperature	0°C to +50°C (+32°F to +122°F)
Relative Humidity	20% to 90% @ 40°C, non-condensing
Operation Vibration	2G, 10 - 500Hz, random for SSD
Certifications	CE

\* W.T.: Wide Temperature. All W.T. supported products have to be sorted by Axiomtek.

## Packing List

- 1 x GOT5103W-845
- 1 x Driver CD
- 1 x Adapter (GOT5103W-845-J)
- 1 x Power cord (GOT5103W-845-J)
- 1 x Phoenix connector (GOT5103W-845 24 VDC)

## Dimensions

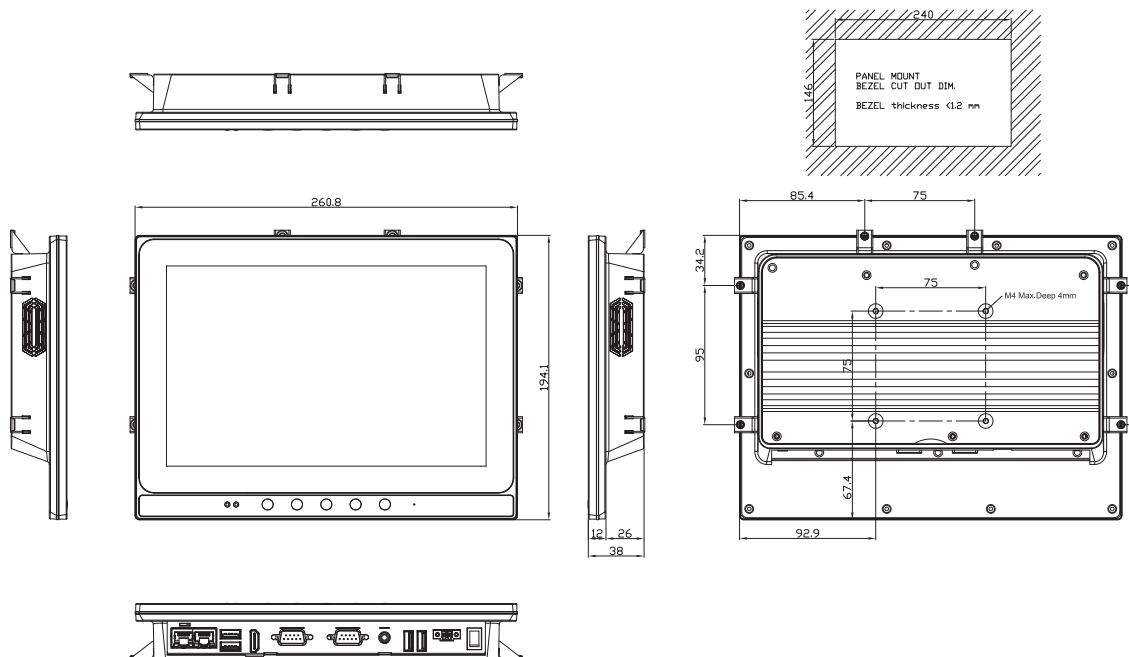

## Ordering Information

Standard	
GOT5103W-845-PCT-J	10.1" WXGA fanless touch panel computer with Intel® Celeron® processor N3060, projected capacitive multi-touch screen, AC-DC 60W power adapter (screw type connector) and EMI class A
GOT5103W-845-PCT-24VDC	10.1" WXGA fanless touch panel computer with Intel® Celeron® processor N3060, projected capacitive multi-touch screen and 24 VDC terminal block connector
GOT5103W-845-PCT-J with OSD	10.1" WXGA fanless touch panel computer with Intel® Celeron® processor N3060, projected capacitive multi-touch screen, AC-DC 60W power adapter (screw type connector) and EMI class A (with membrane keys)
GOT5103W-845-PCT-24VDC with OSD	10.1" WXGA fanless touch panel computer with Intel® Celeron® processor N3060, projected capacitive multi-touch screen and 24 VDC terminal block connector (with membrane keys)

## Optional Accessories

Wi-Fi + Bluetooth kit	
82251030080E	GOT5103W-845 half slim SSD kit SFP for GOT5103W-845-PCT-J
881251030A0E	Panel mount kit
881238460A0E	Wall mount kit
881251203A0E	RFID kit
E226171119	Stand kit

\* Specifications and certifications may vary based on different requirements.

## Optional EOS Installation

WES7
WE8S (64-bit)
Windows® 10 IoT Enterprise (64bit)

## Optional OS Installation

Windows® 7
Windows® 8.1 (64-bit)
Windows® 10

# GOT5153W-845

15.6" WXGA TFT Fanless Touch Panel Computer with Intel® Celeron® Processor N3060

## Features

- 15.6" WXGA wide screen TFT LCD display with LED backlight
- 15.6" projected capacitive touch or 5-wire flat resistive touch
- Fanless design with Intel® Celeron® processor N3060
- 2.5" SATA HDD or mSATA
- 2 GbE LANs, 4 USB, 2 COM and speakers
- IP65-rated front bezel and IPX1 full enclosure
- Supports wall mount, VESA arm and desktop stand
- Supports RFID (optional)



▲ Rear view

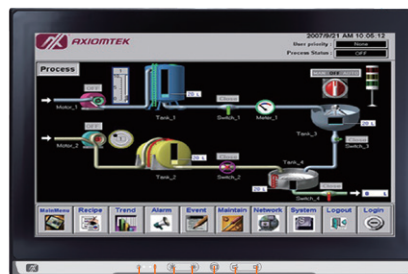

1. Power LED
2. HDD LED
3. Brightness adjust +/-
4. Display on/off
5. Volume adjust

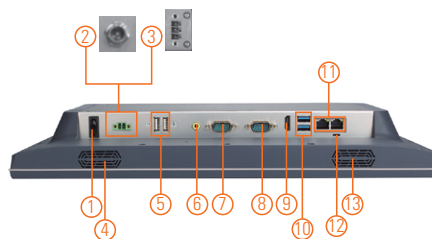

1. Power switch (ATX)
2. Power input connector (screw)
3. Power input connector (phoenix)
4. Speaker
5. 2 x USB 2.0
6. Audio (Line-out)
7. 1 x RS-232/422/485
8. 1 x RS-232
9. 1 x HDMI
10. 2 x USB 3.0
11. 2 x LAN
12. AT/ATX selectable switch
13. Speaker

## Introduction

The GOT5153W-845 is a 15.6" fanless touch panel computer. In response to market demand, this panel computer is a cost effective solution. It adopts a modern, sleek and fanless design and is equipped with the Intel® Celeron® processor N3060 up to 2.48 GHz. For wireless network connection, the GOT5153W-845 offers two PCI Express Mini Card slots. By just plugging in a WLAN card, customers can have instant access to wireless LAN/GPRS/GSM/4G environments. Besides, it provides two types of power input. One is DC power input (9 to 36VDC) with terminal block connector, and another is AC power adapter with screw type connector.

### Slim & Lightweight Design

The GOT5153W-845 is slim and lightweight which make it fit for limited space installation.

### Built-in Internal WLAN Antenna

The GOT5153W-845 provides two PCI Express Mini Card slots and a built-in WLAN antenna for wireless network connections. By simply plugging in the wireless LAN card, customers can use the GOT5153W-845 in wireless LAN/GPRS/GPS/4G environment.

### Support Front Membrane Keys (optional)

The GOT5153W-845 has 5 membrane keys on the front panel which allows users to adjust the LCD on/off, LCD brightness and volume setting easily.

## Specifications

Front Bezel	IP65, NEMA 4 rugged protection, plastic front bezel	
LCD Panel	Display Type	15.6" WXGA TFT LCD with LED backlight
	Brightness (cd/m <sup>2</sup> )	300 nits
	Resolution	1366 x 768
Main System	CPU	Intel® Celeron® processor N3060 2 cores (up to 2.48 GHz)
	System Memory	1 x 204-pin DDR3L-1600 SO-DIMM, up to 8GB
	BIOS	AMI UEFI BIOS
	Storage	1 x 2.5" SATA HDD (9.5 mm height) (AC version only) 1 x mSATA
	Watchdog Timer	255 levels, 0 to 255 sec.
	Onboard Graphics	Integrated Intel® HD GFX

## Specifications

I/O Connector	1 x RS-232/422/485 (default RS-232) 1 x RS-232 1 x AT/ATX mode selection switch 1 x Switch for power on/off 2 x USB 2.0 2 x USB 3.0 1 x HDMI 1 x Audio (Line-out) 2 x 10/100/1000 Mbps Ethernet (Intel® i211-AT)
TPM	N/A
Expansion Interface	1 x Full-size PCI Express Mini Card with mSATA 1 x Full-size PCI Express Mini Card with SIM
Touchscreen	Projected capacitive multi-touch 5-wire flat resistive touch
Power Supply	DC version: 9 to 36 VDC with over-current protection fuse AC version: 100 to 240 VAC-DC, 60W power adapter
Power Consumption	30W
Dimensions	394.2 mm (15.53") (W) x 57 mm (2.25") (D) x 257.2 mm (10.13") (H)
Packing Dimensions	510 mm (20.09") x 190 mm (7.48") x 540 mm (21.26")
Weight (net/gross)	3.0 kg (6.61 lb)/4.5 kg (9.92 lb)
Operating Temperature	0°C to +50°C (+32°F to +122°F) with W.T. DRAM/SSD
Relative Humidity	20% to 90% @ 40°C; non-condensing
Operation Vibration	2G, 5 - 500Hz, random for CFast™
Certifications	CE

\* W.T.: Wide Temperature. All W.T. supported products have to be sorted by Axiomtek.

## Packing List

- 1 x GOT5153W-845
- 1 x Driver CD
- 1 x Adapter (GOT5153W-845-J)
- 1 x Power cord (GOT5153W-845-J)
- 1 x Phoenix connector (GOT5153W-845 24 VDC)

## Ordering Information

Standard	
GOT5153W-845-PCT-J	15.6" WXGA fanless touch panel computer with Intel® Celeron® processor N3060, projected capacitive multi-touch screen and AC-DC 60W power adapter (screw type connector)
GOT5153W-845-FR-J	15.6" WXGA fanless touch panel computer with Intel® Celeron® processor N3060, 5-wire flat resistive touch screen and AC-DC 60W power adapter (screw type connector)
GOT5153W-845-PCT-DC	15.6" WXGA fanless touch panel computer with Intel® Celeron® processor N3060, projected capacitive multi-touch screen and 9 to 36 VDC terminal block connector
GOT5153W-845-FR-DC	15.6" WXGA fanless touch panel computer with Intel® Celeron® processor N3060, 5-wire flat resistive touch screen and 9 to 36 VDC terminal block connector

## Optional Accessories

Wi-Fi + Bluetooth kit	
881251203A0E	RFID kit
E226171119	Stand kit
82231770050E	Wall mount kit

\* Specifications and certifications may vary based on different requirements.

## Optional EOS Installation

- WES7
- WE8S (64-bit)
- Windows® 10 IoT Enterprise (64bit)

## Optional OS Installation

- Windows® 7
- Windows® 8.1 (64-bit)
- Windows® 10

## Dimensions

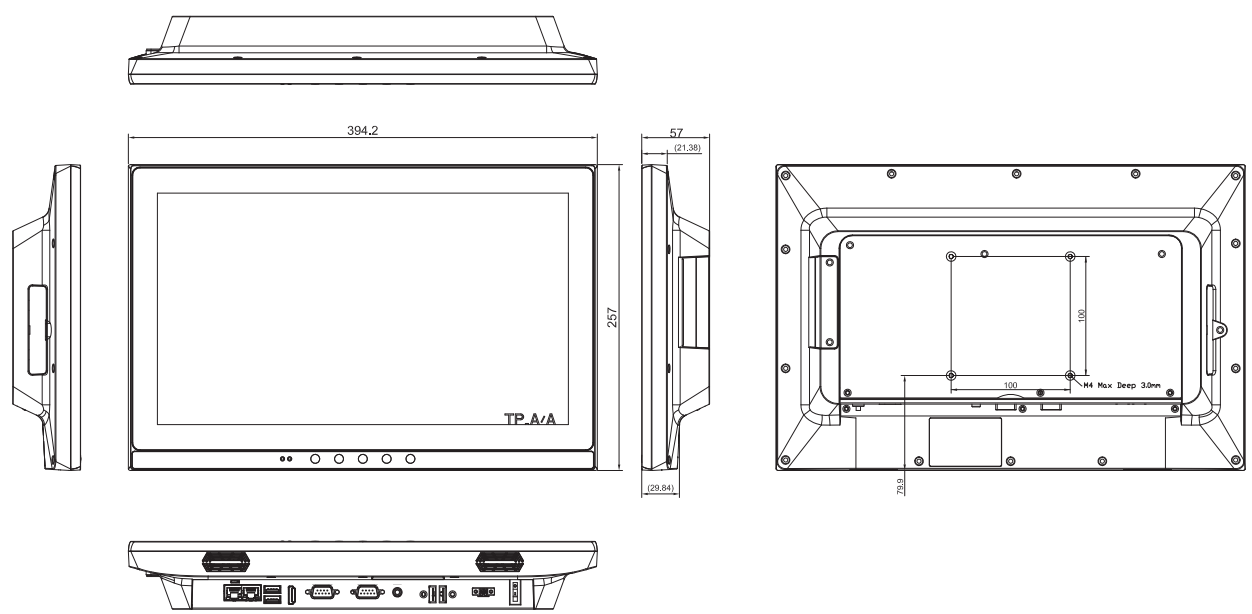



Fanless Touch Panel Computers

Heavy-duty Fanless Touch Panel Computers

Vehicle Mount Terminal Computer

Stainless Touch Panel Computers

Transportation Touch Panel Computers and Displays

Industrial Touch Panel Computers

Industrial Touch Monitors

Medical Panel Computers

Open Frame Panel Computer



# Industrial Panel PCs



# 2

## Heavy-duty Fanless Touch Panel Computers

Axiomtek's heavy-duty GOT300 series is designed for kiosk and automation applications. It has a fashionable mechanism design and industrial-grade IP65-rated front bezels for water/dust-proof operation. It is suitable for use in industrial automation and control systems, building automation, machinery manufacturing environments, self-service kiosks, and other HMI applications.

	Selection Guide	259	
	GOT315WL-845-PCT	15.6" WXGA TFT Multi-touch Panel Computer with Intel® Pentium® Processor N3710	261
	GOT317-502-FR	17" SXGA TFT Expandable Touch Panel Computer with 7th/6th Gen Intel® Core™ i7/i5/i3 Processor	263
	GOT3177T-311-FR	17" SXGA TFT Flat Bezel Expandable Touch Panel Computer with Intel® Pentium® Processor N4200	265
	GOT318WL-845-PCT	18.5" WXGA TFT Multi-touch Panel Computer with Intel® Pentium® Processor N3710	267
	GOT321W-502-PCT	21.5" FHD TFT Multi-touch Panel Computer with 7th/6th Gen Intel® Core™ i7/i5/i3 Processor	269
	GOT3217WL-845-PCT	21.5" FHD TFT Multi-touch Panel Computer with Intel® Pentium® Processor N3710	271

# Heavy-duty Fanless Touch Panel Computers

## Selection Guide

NEW



Features/Models	GOT315WL-845-PCT	GOT317-502-FR	GOT3177T-311
<b>CPU Level</b>	Intel® Pentium® processor N3710 4C @ 1.6 GHz (Braswell)	LGA1151 socket 7th/6th gen Intel® Core™ i7/i5/i3, Pentium® & Celeron® processor (Kaby lake/Skylake)	Intel® Pentium® N4200 4C @ 1.1 GHz (up to 2.5 GHz)
<b>Chipset</b>	SoC integrated	Intel® H110	SoC integrated
<b>System Memory</b>	1 x 204-pin DDR3L-1333/1600 SO-DIMM, up to 8GB	2 x 260-pin DDR4-2400 SO-DIMM, up to 32GB	1 x 204-pin DDR3L-1333/1600 SO-DIMM, up to 8GB
<b>Display</b>	15.6" WXGA TFT LCD, 400 nits	17" SXGA TFT, 350 nits	17" SXGA TFT, 350 nits
<b>I/O</b>	1 x RS-232 1 x RS-232/422/485 1 x Switch for power on/off (ATX) 1 x Audio (Line-out) 2 x USB 3.0 2 x USB 2.0 2 x 10/100/1000 Mbps Ethernet (Intel® i217-LM & i210-AT)	2 x RS-232/422/485 1 x HDMI v1.4 1 x VGA (up to 1920 x 1200 60Hz) 1 x DisplayPort v1.2 (DP++) 4 x USB 3.0 2 x 10/100/1000 Mbps Ethernet (Intel® i219LM/i211AT) 1 x Audio (Mic-in/Line-out)	2 x RS-232/422/485 2 x RS-232 2 x 10/100/1000 Mbps Ethernet 2 x USB 3.0 2 x USB 2.0 1 x HDMI 2 x Audio (Line-out/Mic-in)
<b>Storage</b>	1 x 2.5" SATA HDD 1 x mSATA	1 x 2.5" SATA HDD	1 x 2.5" HDD 1 x mSATA
<b>Expansion Interface</b>	1 x Full-size PCI Express Mini Card slot 1 x Full-size PCI Express Mini Card slot	1 x Half-size PCI Express Mini Card slot 1 x Full-size PCI Express Mini Card slot	2 x PCI Express Mini Card slot 1 x Half-size PCI Express Mini Card slot Flexible I/O
<b>Touchscreen</b>	Projected capacitive multi-touch	Flat resistive touch	Flat resistive touch
<b>Operating System</b>	Windows® 10	Skylake: Windows® 7, Windows® 8.1, Windows® 10 Kaby Lake: Windows® 10	Windows® 10
<b>Power Supply</b>	DC version: 24 VDC	DC terminal block: +12V / +19V / +24V AC adapter: 19V, 6.32A	9 to 36 VDC
<b>Power Consumption</b>	72W	120W (include 35W processor)	69W
<b>Watchdog Timer</b>	255 levels, 0 to 255 sec.	255 levels, 0 to 255 sec.	255 levels, 0 to 255 sec.
<b>Dimensions (W x D x H)</b>	396.8 x 59.0 x 247.1 mm (15.62" x 2.3" x 9.73")	398.02 x 77.5 x 330.44 mm (15.67" x 3.05" x 13.01")	398.0 x 77.5 x 330.4 mm (15.66" x 3.05" x 13.01")
<b>Weight (net/gross)</b>	4.5 kg (9.9 lb)/6.5 kg (14.3 lb)	6.7 kg (14.77 lb)/9.0 kg (19.84 lb)	5.7 kg (12.6 lb)/8.0 kg (17.6 lb)
<b>Operating Temperature</b>	0°C to +50°C (+32°F to +122°F)	0°C to +40°C (+32°F to +104°F)	-10°C to +50°C (+14°F to +122°F)
<b>Certifications</b>	CE	CE	CE

NEW



Features/Models	GOT318WL-845-PCT	GOT321W-502	GOT3217WL-845
<b>CPU Level</b>	Intel® Pentium® processor N3710 4C @ 1.6 GHz (Braswell)	LGA1151 socket 7th/6th gen Intel® Core™ i7/i5/i3, Pentium® & Celeron® processor (Kaby lake/Skylake)	Intel® Pentium® N3710 4C @ 1.6 GHz (up to 2.56 GHz)
<b>Chipset</b>	SoC integrated	Intel® H110	SoC integrated
<b>System Memory</b>	1 x 204-pin DDR3L-1333/1600 SO-DIMM, up to 8GB	2 x 260-pin DDR4-2400 SO-DIMM, up to 32GB	1 x 204-pin DDR3L-1600 SO-DIMM, up to 8GB
<b>Display</b>	18.5" WXGA TFT LCD, 250 nits	21.5" FHD TFT, 250 nits	21.5" FHD TFT, 250 nits
<b>I/O</b>	<ul style="list-style-type: none"> <li>1 x RS-232</li> <li>1 x RS-232/422/485</li> <li>1 x Switch for power on/off (ATX)</li> <li>1 x Audio (Line-out)</li> <li>2 x USB 3.0</li> <li>2 x USB 2.0</li> <li>2 x 10/100/1000 Mbps Ethernet (Intel® i217-LM &amp; i210-AT)</li> </ul>	<ul style="list-style-type: none"> <li>2 x RS-232/422/485</li> <li>1 x HDMI v1.4</li> <li>1 x VGA (up to 1920 x 1200 60Hz)</li> <li>1 x DisplayPort v1.2 (DP++)</li> <li>4 x USB 3.0</li> <li>2 x 10/100/1000 Mbps Ethernet (Intel® i219-LM/i211-AT)</li> <li>1 x Audio (Mic-in/Line-out)</li> </ul>	<ul style="list-style-type: none"> <li>1 x RS-232</li> <li>1 x RS-232/422/485</li> <li>2 x 10/100/1000 Mbps Ethernet</li> <li>2 x USB 2.0</li> <li>2 x USB 3.0</li> <li>1 x Audio (Line-out)</li> <li>1 x HDMI</li> <li>1 x Switch for power on/off</li> <li>1 x AT/ATX mode selection switch</li> <li>8 x DIO ports (programmable, DB15)</li> </ul>
<b>Storage</b>	1 x 2.5" SATA HDD 1 x mSATA	1 x 2.5" SATA HDD	1 x 2.5" HDD 1 x mSATA
<b>Expansion Interface</b>	1 x Full-size PCI Express Mini Card slot 1 x Full-size PCI Express Mini Card slot	1 x Half-size PCI Express Mini Card slot 1 x Full-size PCI Express Mini Card slot	2 x PCI Express Mini Card slot
<b>Touchscreen</b>	Projected capacitive multi-touch / Flat resistive touch (optional)	10-point projected capacitive multi-touch	10-point projected capacitive multi-touch
<b>Operating System</b>	Windows® 10	Skylake: Windows® 7, Windows® 8.1, Windows® 10 (64-bit) Kaby Lake: Windows® 10	Windows® 10, Windows® 8.1, WEBS, Windows® 7, WES 7
<b>Power Supply</b>	DC version: 24 VDC	DC terminal block: +12V / +19V / +24V AC adapter: 19V, 6.32A	24 VDC 100 to 240V, AC-DC 60W power adapter
<b>Power Consumption</b>	48W	105W	48W
<b>Watchdog Timer</b>	255 levels, 0 to 255 sec.	255 levels, 0 to 255 sec.	255 levels, 0 to 255 sec.
<b>Dimensions (W x D x H)</b>	460.8 x 58.5 x 285 mm (18.11" x 2.3" x 11.22")	547.59 x 339.05 x 75.6 mm (21.56" x 13.49" x 2.98")	547.6 x 58.5 x 339.0 mm (21.56" x 2.30" x 13.35")
<b>Weight (net/gross)</b>	5.8 kg (12.8 lb)/8.2 kg (18.1 lb)	8.4 kg (18.5 lb)/11.3 kg (24.9 lb)	7.6 kg (16.8 lb)/10.5 kg (23.1 lb)
<b>Operating Temperature</b>	0°C to +50°C (+32°F to +122°F)	0°C to +40°C (+32°F to +104°F)	0°C to +50°C (+32°F to +122°F)
<b>Certifications</b>	CE	CE	CE

Heavy-duty  
Fanless  
Touch Panel  
Computers

1

2

3

4

5

6

7

8

9

# GOT315WL-845-PCT NEW

15.6" WXGA TFT Multi-touch Panel Computer with Intel® Pentium® Processor N3710

## Features

- 15.6" WXGA projected capacitive multi-touch wide screen
- Fanless design with Intel® Pentium® processor N3710
- 2.5" SATA HDD & mSATA
- 3G, WLAN module & antennas (optional)
- 2 GbE LANs, 2 USB 3.0, 2 USB 2.0 and 2 COM
- IP65-rated aluminum front bezel
- Supports panel mount and VESA mount (VESA arm/desktop stand/wall mount optional)
- Adjustable RS-232/422/485 setting via BIOS

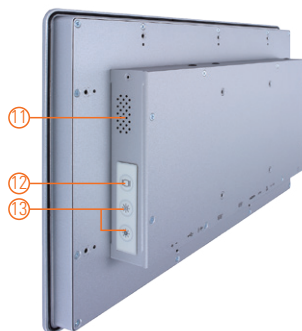

▲ Rear view

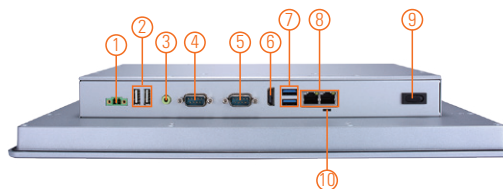

- |                                      |                              |                           |
|--------------------------------------|------------------------------|---------------------------|
| 1. Terminal block for DC power input | 6. HDMI                      | 11. Speaker               |
| 2. 2 x USB 2.0                       | 7. 2 x USB 3.0               | 12. Blacklight switch     |
| 3. Audio (Line-out)                  | 8. 2 x LAN                   | 13. Brightness adjust +/- |
| 4. 1 x RS-232/422/485                | 9. Power switch (ATX)        |                           |
| 5. 1 x RS-232                        | 10. AT/ATX selectable switch |                           |



## Introduction

The GOT315WL-845 adopts a 15.6-inch WXGA LCD and supports low power Intel® Pentium® processor N3710. It also provides two PCI Express Mini Card slots for 3G, wireless network connectivity. This 15.6" multi-touch panel computer is suitable for transportation, heavy-duty industry, smart factory automation, and oil pipe monitoring systems.

### 15.6-inch WXGA LCD with Projected Capacitive Multi-touch

The 15.6" WXGA touch panel PC supports 400 nits brightness, able to display contents in HD resolution. With projected capacitive multi-touch screen, users can operate the device more directly and friendly. The hardness of touch glass surface is up to 7h for anti-scratch purpose.

### WLAN Antenna Supported (optional)

The GOT315WL-845 provides two PCI Express Mini Card slots and WLAN antennas for 3G and wireless network connectivity.

## Specifications

Front Bezel	IP65 front bezel	
LCD Panel	Display Type	15.6" WXGA TFT LCD
	Brightness (cd/m <sup>2</sup> )	400 nits
	Resolution	1366 x 768
Main System	CPU	Intel® Pentium® processor N3710 4C @ 1.6 GHz (Braswell)
	Chipset	SoC integrated
	System Memory	1 x 204-pin DDR3L-1333/1600 SO-DIMM, up to 8GB
	BIOS	AMI UEFI BIOS
	Storage	1 x 2.5" SATA HDD (9.5 mm height) 1 x mSATA
	Watchdog Timer	255 levels, 0 to 255 sec.
	Onboard Graphics	Integrated Intel® HD Graphics

## Specifications

I/O Connector	1 x RS-232 1 x RS-232/422/485 1 x Switch for power on/off (ATX) 1 x Audio (Line-out) 2 x USB 3.0 2 x USB 2.0 2 x 10/100/1000 Mbps Ethernet (Intel® i217-LM & i210-AT)
TPM	N/A
Expansion Interface	1 x Full-size PCI Express Mini Card slot with mSATA 1 x Full-size PCI Express Mini Card slot with SIM
Touchscreen	Projected capacitive multi-touch
Power Supply	DC version: 24 VDC
Power Consumption	72W
Dimensions	396.8 mm (15.62") (W) x 59.0 mm (2.3") (D) x 247.1 mm (9.73") (H)
Packing Dimensions	525 mm (20.67") (W) x 186 mm (7.32") (D) x 470 mm (18.51") (H)
Weight (net/gross)	4.5 kg (9.9 lb)/6.5 kg (14.3 lb)
Operating Temperature	0°C to +50°C (+32°F to +122°F)
Relative Humidity	20% to 90% @ +40°C; non-condensing
Operation Vibration	1G, 10 - 500 Hz, random for 2.5" SATA HDD
Certifications	CE

## Packing List

- 1 x GOT315WL-845
- 1 x Driver CD
- 1 x Phoenix connector
- 1 x Panel mount kit

## Dimensions

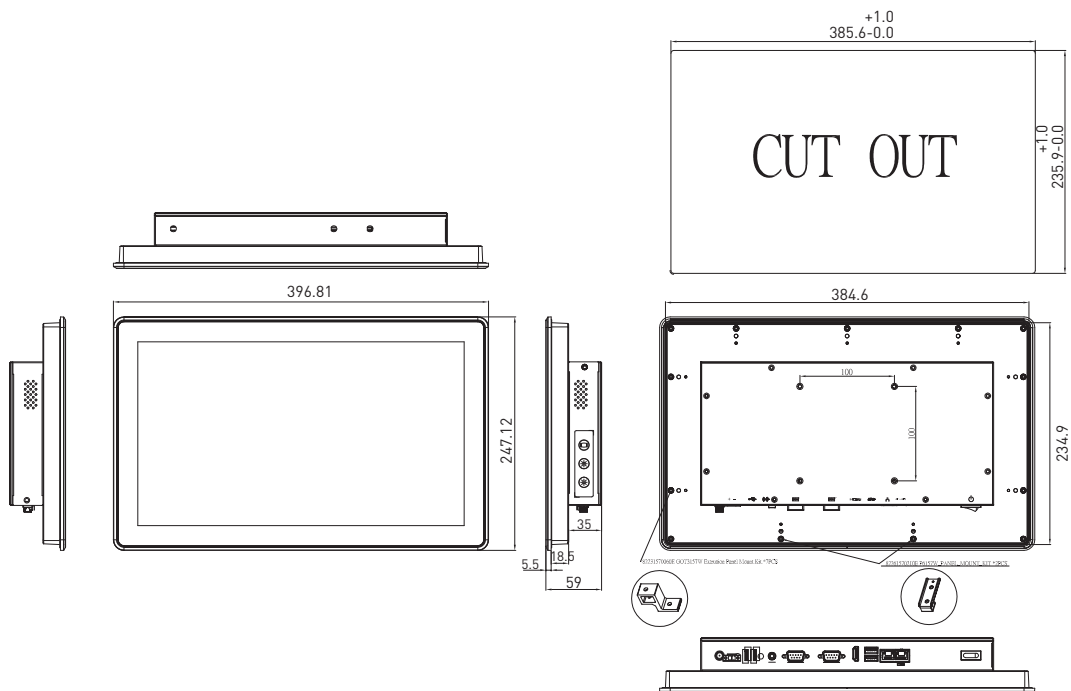

## Ordering Information

GOT315WL-845-PCT-DC	15.6" WXGA TFT fanless touch panel computer with Intel® Pentium® N3710 1.6 GHz quad core processor, projected capacitive multi-touch screen and 24 VDC terminal block connector
---------------------	---

## Optional Accessories

Wi-Fi kit + 4G	
82231770050E	GOT3177T-834 wall mount kit
50906D24000E	Adaptor 24V/120W, wire only, FSP120-AAAN3

\*Specifications and certifications may vary based on different requirements.

## Optional EOS Installation

Windows® 10 IoT Enterprise

## Optional OS Installation

Windows® 10

# GOT317-502-FR

17" SXGA TFT Expandable Touch Panel Computer with 7th/6th Gen Intel® Core™ i7/i5/i3 Processor

## Features

- 17" SXGA TFT flat resistive touch
- LGA1151 socket 7th/6th gen Intel® Core™ i7/i5/i3, Celeron® & Pentium® processor
- Intel® H110 chipset
- 2 LANs, 4 USB 3.0 and 2 COM
- 2.5" SATA HDD and mSATA
- WLAN module & antenna (optional)
- IP65-rated front bezel
- Supports panel mount and VESA mount (VESA arm/desktop stand/wall mount optional)
- Built-in speakers and swappable hard drive design

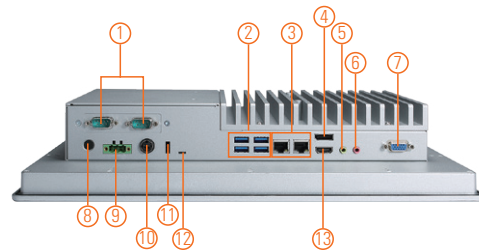
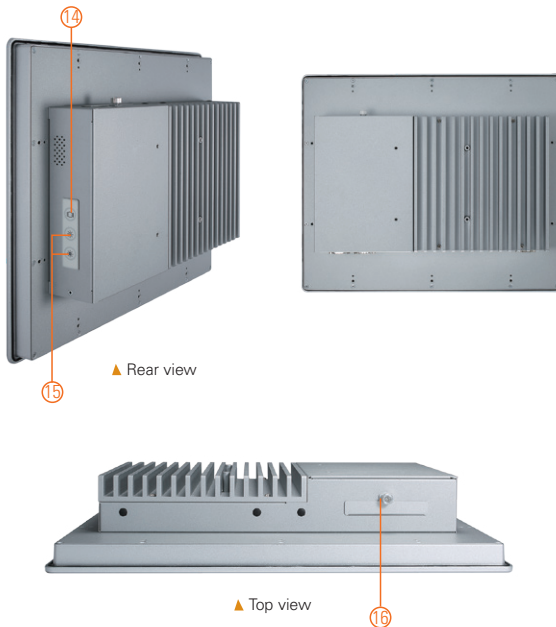
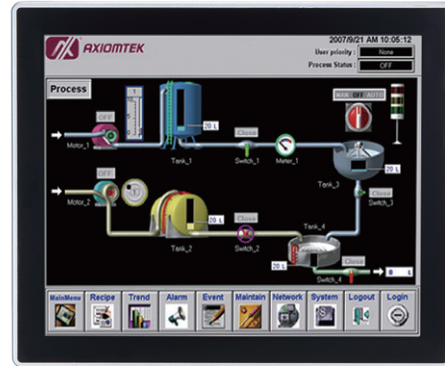

- |                    |                                      |                           |
|--------------------|--------------------------------------|---------------------------|
| 1. 2 x COM (cable) | 7. VGA (cable)                       | 13. HDMI                  |
| 2. 4 x USB 3.0     | 8. Power button (ATX)                | 14. Backlight switch      |
| 3. 2 x LAN         | 9. Terminal block for DC power input | 15. Brightness adjust +/- |
| 4. DisplayPort     | 10. Power input connector            | 16. Swappable HDD         |
| 5. 1 x Line-out    | 11. Remote power switch port         |                           |
| 6. 1 x Mic-in      | 12. AT/ATX selectable switch         |                           |



## Introduction

The GOT317-502-FR is a multimedia 17" touch panel PC for kiosk application. It has a fashionable mechanism design and industrial-grade material front bezel which can avoid damage from chemical corrosion. To meet the demands of multimedia application, the GOT317-502-FR is powered by a high performance LGA1151 socket 7th/6th generation Intel® Core™ processor with the Intel® H110 chipset. It features two COM ports, two Gigabit Ethernet and up to 32GB memory of dual-channel DDR4-2400 that delivers high computing capability for high performance-demanding applications. The industrial touch panel PC is suitable for kiosk and factory automation.

### Swappable hard drive design

The GOT317-502-FR is equipped with an easy-swappable 2.5" HDD for extensive storage needs.

### Speaker and WLAN Antenna Supported

The GOT317-502-FR is equipped with built-in speakers for multimedia applications. It also supports WLAN module antenna (optional) for wireless network connectivity.

## Specifications

Front Bezel	Aluminum w/ IP65/NEMA 4 rugged protection	
LCD Panel	Display Type	17" SXGA TFT LCD
	Brightness	350 nits
	Resolution	1280 x 1024 pixels
	Viewing Angle	160°/140°
Main System	CPU	LGA1151 socket 7th/6th gen Intel® Core™ i7/i5/i3, Celeron® & Pentium® processor
	Chipset	Intel® H110
	System Memory	2 x 260-pin DDR4-2400 SO-DIMM, up to 32GB
	BIOS	AMI UEFI BIOS
	Storage	1 x 2.5" SATA HDD (9.5 mm height)
	Drive	N/A
	Watchdog Timer	255 levels, 1 to 255 sec.



## Specifications

IO Connector	2 x RS-232/422/485 1 x HDMI v1.4 1 x VGA (up to 1920 x 1200 60Hz) 1 x DisplayPort v1.2 (DP++) 4 x USB 3.0 2 x 10/100/1000 Mbps Ethernet (Intel® i219-LM & i211-AT) 1 x Audio (Mic-in & Line-out)
TPM	N/A
Expansion Interface	1 x Half-size PCI Express Mini Card slot with mPCIe 1 1 x Full-size PCI Express Mini Card slot with mSATA or mPCIe 2
Touchscreen	Flat resistive touch
Power Supply	DC terminal block: +12V/+19V/+24V AC adapter: 19V, 6.32A
Power Consumption	120W (include 35W processor)
Dimensions	398.02 mm (15.67") (W) x 77.5 mm (3.05") (D) x 330.44 mm (13.01") (H)
Packing Dimensions	510 mm (20.08") (W) x 190 mm (7.48") (D) x 540 mm (21.26") (H)
Weight (net/gross)	6.7 kg (14.77 lb)/9.0 kg (19.84 lb)
Operating Temperature	0°C to +40°C (+32°F to +104°F)
Relative Humidity	10% to 90% @ +40°C, non-considering
Operating Vibration	1.0G, 5 - 500Hz, random
Certifications	CE

## Packing List

- 1 x GOT317-502-FR
- 1 x Driver CD
- 1 x Phoenix connector
- 1 x Panel mount kit
- 1 x Adapter

## Dimensions

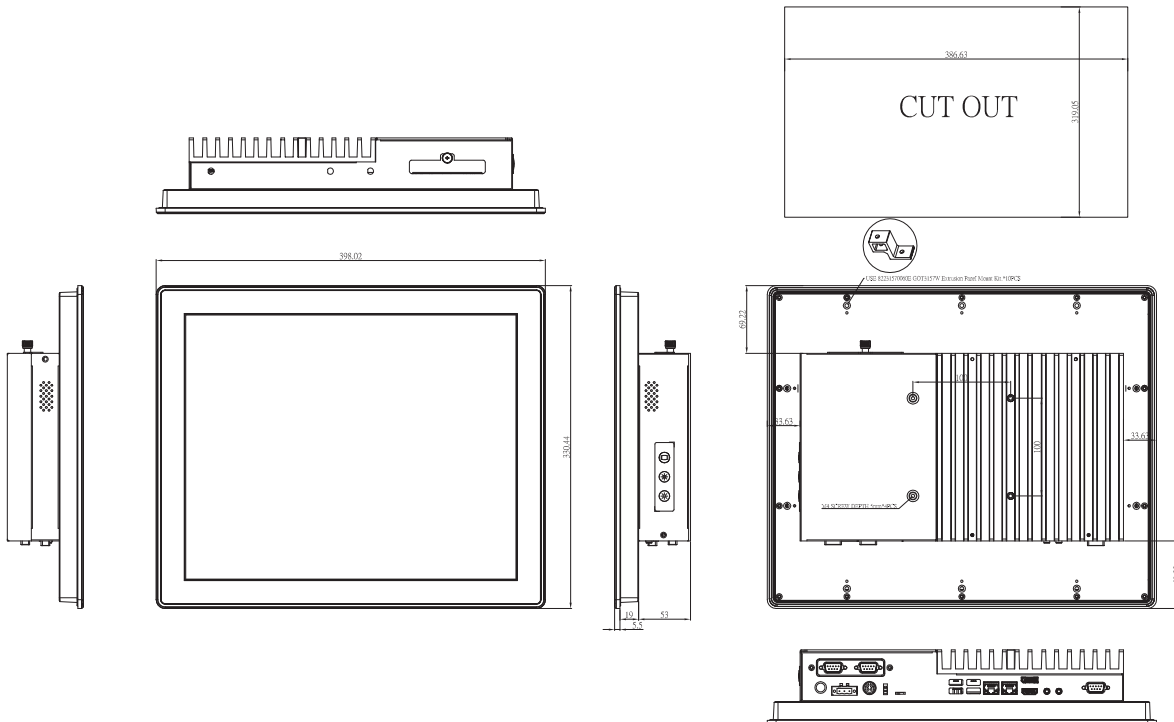

## Ordering Information

GOT317-502-FR-DC	17" SXGA TFT fanless touch panel computer with LGA1151 socket 7th/6th gen Intel® Core™, Pentium® & Celeron® processor, 5-wire flat resistive touch screen and 12/19/24 VDC terminal block connector
------------------	---

\* Specifications and certifications may vary based on different requirements.

## Optional Accessories

Wi-Fi kit	
82231770060E	Rack mount kit
82231770050E	GOT3177T-834 wall mount kit

## Optional EOS Installation

Windows® 7
Windows® 8.1
Windows® 10 IoT Enterprise

## Optional OS Installation

Skylake: Windows® 7
Windows® 8.1
Windows® 10
Kaby Lake: Windows® 10

# GOT3177T-311-FR

17" SXGA TFT Flat Bezel Expandable Touch Panel Computer with Intel® Pentium® Processor N4200

## Features

- 17" SXGA TFT flat resistive touch
- Fanless and modularized design
- Intel® Pentium® processor N4200 (Apollo Lake-M)
- 2.5" 7/9.5 mm SATA HDD and mSATA
- WLAN module & antenna (optional)
- 2 GbE LAN, 2 USB 2.0, 2 USB 3.0 and 4 COM
- 1 PCIe riser card expansion slot (optional)
- IP65-rated front bezel
- Supports panel mount and VESA mount (VESA arm/desktop stand/wall mount optional)

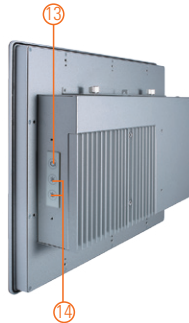
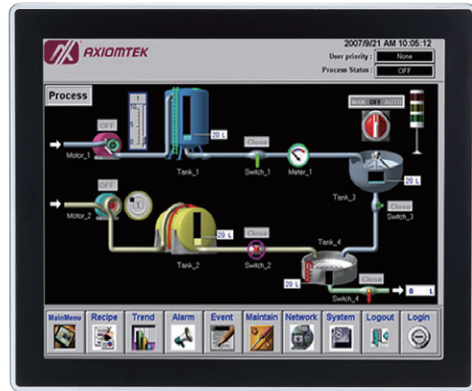

▲ Rear view

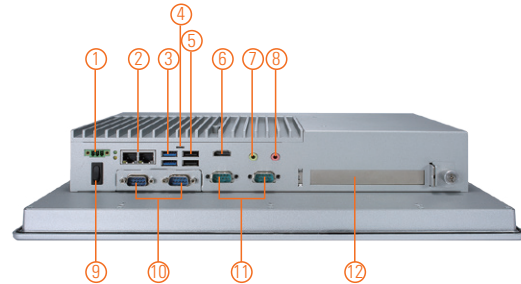

1. Terminal block for DC power input
2. 2 x LAN
3. 2 x USB 3.0
4. AT/ATX selectable switch
5. 2 x USB 2.0
6. 1 x HDMI
7. 1 x Line-out
8. 1 x Mic-in
9. Power switch (ATX)
10. 2 x COM (cable)
11. 2 x COM (onboard)
12. 1 x PCIe riser card expansion slot (optional)
13. Backlight switch
14. Brightness adjust +/-



▲ Top view

## Introduction

The GOT3177T-311-FR adopts a 17-inch SXGA LCD and supports Intel® Apollo Lake processor. By supporting a wide range operating temperature from 0°C to +60°C, it can be used in harsh environment. The rugged industrial panel PC supports low power Intel® Pentium® processor N4200. It also provides 2 PCI Express Mini Card slots for 3G, wireless network connectivity and 1 PCIe riser card slot (optional) for more expansions. The 17" flat front bezel touch panel computer is suitable for transportation, heavy-duty industry, smart factory automation, and oil pipe monitoring systems.

### Wide Temperature Range

The Intel® Apollo Lake-based GOT3177T-311-FR has a wide operating temperature of 0°C to +60°C as well as fanless operation. It also has a compact design for space-constraining applications.

### WLAN Antenna Supported (optional)

The GOT3177T-311-FR provides 2 PCI Express Mini Card slots and WLAN/3G antennas for wireless network connectivity.

## Specifications

Front Bezel	IP65 front bezel	
LCD Panel	Display Type	17" SXGA TFT LCD
	Brightness (cd/m <sup>2</sup> )	350 nits
	Resolution	1280 x 1024
Main System	CPU	Intel® Pentium® processor N4200 4C @ 1.6 GHz (Apollo Lake-M)
	Chipset	SoC integrated
	System Memory	1 x 204-pin DDR3L-1333/1600 SO-DIMM, up to 8GB
	BIOS	AMI UEFI BIOS
	Storage	1 x 2.5" SATA HDD (9.5 mm height) 1 x mSATA
	Watchdog Timer	255 levels, 0 to 255 sec.
	Onboard Graphics	Integrated Intel® HD Graphics

## Specifications

I/O Connector	2 x RS-232 2 x RS-232/422/485 (default RS-232) 2 x Audio (Line-out/Mic-in) 2 x USB 2.0 2 x USB 3.0 2 x 10/100/1000 Mbps Ethernet (Intel® i210-IT)
TPM	N/A
Expansion Interface	1 x Full-size PCI Express Mini Card slot with SIM 1 x Full-size PCI Express Mini Card slot with mSATA 1 x PCIe riser card slot (optional)
Touchscreen	Flat resistive touch
Power Supply	DC version: 9 to 36 VDC
Power Consumption	69W
Dimensions	398.02 mm (15.64") (W) x 59.9 mm (2.36") (D) x 330.44 mm (13.01") (H)
Packing Dimensions	510 mm (20.08") (W) x 190 mm (7.48") (D) x 540 mm (21.26") (H)
Weight (net/gross)	5.7 kg (12.6 lb) /8.0 kg (17.6 lb)
Operating Temperature	0°C to +60°C (+32°F to +140°F)
Relative Humidity	20% to 90% @ +40°C; non-condensing
Operation Vibration	1.0G, 10 - 500Hz
Certifications	CE

## Packing List

- 1 x GOT3177T-311-FR
- 1 x Driver CD
- 1 x Phoenix connector
- 1 x Panel mount kit

## Ordering Information

GOT3177T-311-FR-DC	17" SXGA TFT fanless touch panel computer with Intel® Pentium® processor N4200 1.6 GHz quad core, 5-wire flat resistive touch screen and 9 to 36 VDC terminal block connector
--------------------	---

## Optional Accessories

82231770050E	GOT3177T-834 wall mount kit
83907131000E	AX90713 GOT3177T-311 backplane (PCIe riser card)
50906D24000E	Adaptor 24V/120W, wire only, FSP120-AAAN3

\*Specifications and certifications may vary based on different requirements.

## Optional EOS Installation

Windows® 10 IoT Enterprise

## Optional OS Installation

Windows® 10

## Dimensions

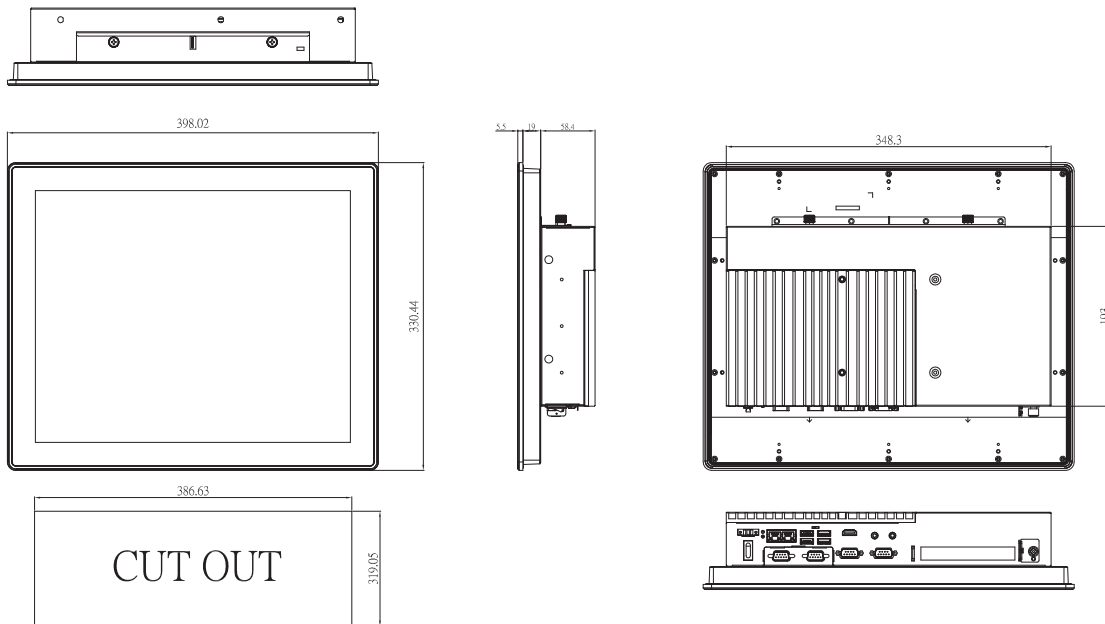

# GOT318WL-845-PCT NEW

18.5" WXGA TFT Multi-touch Panel Computer with Intel® Pentium® Processor N3710

## Features

- 18.5" WXGA multi-touch projected capacitive widescreen or flat resistive touch (optional)
- Fanless design with Intel® Pentium® processor N3710
- 2.5" SATA HDD & mSATA
- 3G, WLAN module & antennas (optional)
- 2 GbE LANs, 2 USB 3.0, 2 USB 2.0 and 2 COM
- IP65-rated aluminum front bezel
- Supports panel mount and VESA mount (VESA arm/desktop stand/wall mount optional)
- Adjustable RS-232/422/485 setting via BIOS

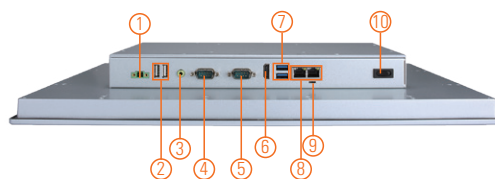
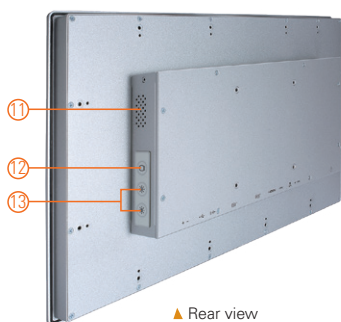

- |                                      |                             |                           |
|--------------------------------------|-----------------------------|---------------------------|
| 1. Terminal block for DC power input | 6. HDMI                     | 11. Speaker               |
| 2. 2 x USB 2.0                       | 7. 2 x USB 3.0              | 12. Backlight switch      |
| 3. Audio (Line-out)                  | 8. 2 x LAN                  | 13. Brightness adjust +/- |
| 4. 1 x RS-232/422/485                | 9. AT/ATX selectable switch |                           |
| 5. 1 x RS-232                        | 10. Power switch (ATX)      |                           |



## Introduction

The GOT318WL-845 adopts an 18.5-inch WXGA LCD and supports low power Intel® Pentium® processor N3710. It also provides two PCI Express Mini Card slots for 3G, wireless network connectivity. This 18.5" multi-touch panel computer is suitable for transportation, heavy-duty industry, smart factory automation, and oil pipe monitoring systems.

### 18.5-inch WXGA LCD with Projected Capacitive Multi-touch

The 18.5" WXGA touch panel PC supports 250 nits brightness, able to display contents in HD resolution. With projected capacitive multi-touch screen, users can operate the device more directly and friendly. The hardness of touch glass surface is up to 7h for anti-scratch purpose.

### WLAN Antenna Supported (optional)

The GOT318WL-845 provides two PCI Express Mini Card slots and WLAN antennas for 3G and wireless network connectivity.

## Specifications

Front Bezel	IP65 front bezel	
LCD Panel	Display Type	18.5" WXGA TFT LCD
	Brightness (cd/m <sup>2</sup> )	250 nits
	Resolution	1366 x 768
Main System	CPU	Intel® Pentium® processor N3710 4C @ 1.6 GHz (Braswell)
	Chipset	SoC integrated
	System Memory	1 x 204-pin DDR3L-1333/1600 SO-DIMM, up to 8GB
	BIOS	AMI UEFI BIOS
	Storage	1 x 2.5" SATA HDD (9.5 mm height) 1 x mSATA
	Watchdog Timer	255 levels, 0 to 255 sec.
	Onboard Graphics	Integrated Intel® HD Graphics

## Specifications

I/O Connector	1 x RS-232 1 x RS-232/422/485 1 x Switch for power on/off (ATX) 1 x Audio (Line-out) 2 x USB 3.0 2 x USB 2.0 2 x 10/100/1000 Mbps Ethernet (Intel® i217-LM & i210-AT)
TPM	N/A
Expansion Interface	1 x Full-size PCI Express Mini Card slot with mSATA 1 x Full-size PCI Express Mini Card slot with SIM
Touchscreen	Projected capacitive multi-touch/flat resistive touch (optional)
Power Supply	DC version: 24 VDC
Power Consumption	48W
Dimensions	460.8 mm (18.11") (W) x 58.5 mm (2.3") (D) x 285 mm (11.22") (H)
Packing Dimensions	600 mm (23.58") (W) x 195 mm (7.67") (D) x 500 mm (19.68") (H)
Weight (net/gross)	5.8 kg (12.8 lb)/8.2 kg (18.1 lb)
Operating Temperature	0°C to +50°C (+32°F to +122°F)
Relative Humidity	20% to 90% @ +40°C; non-condensing
Operation Vibration	1G, 10 - 500 Hz, random for 2.5" SATA HDD
Certifications	CE

## Packing List

- 1 x GOT318WL-845
- 1 x Driver CD
- 1 x Phoenix connector
- 1 x Panel mount kit

## Ordering Information

GOT318WL-845-PCT-DC	18.5" WXGA TFT fanless touch panel computer with Intel® Pentium® N3710 1.6 GHz quad core processor, projected capacitive multi-touch screen and 24 VDC terminal block connector
---------------------	---

## Optional Accessories

Wi-Fi kit + 4G	
82231770050E	GOT3177T-834 wall mount kit
50906D24000E	Adaptor 24V/120W, wire only, FSP120-AAAN3

\* Specifications and certifications may vary based on different requirements.

## Optional EOS Installation

Windows® 10 IoT Enterprise

## Optional OS Installation

Windows® 10

## Dimensions

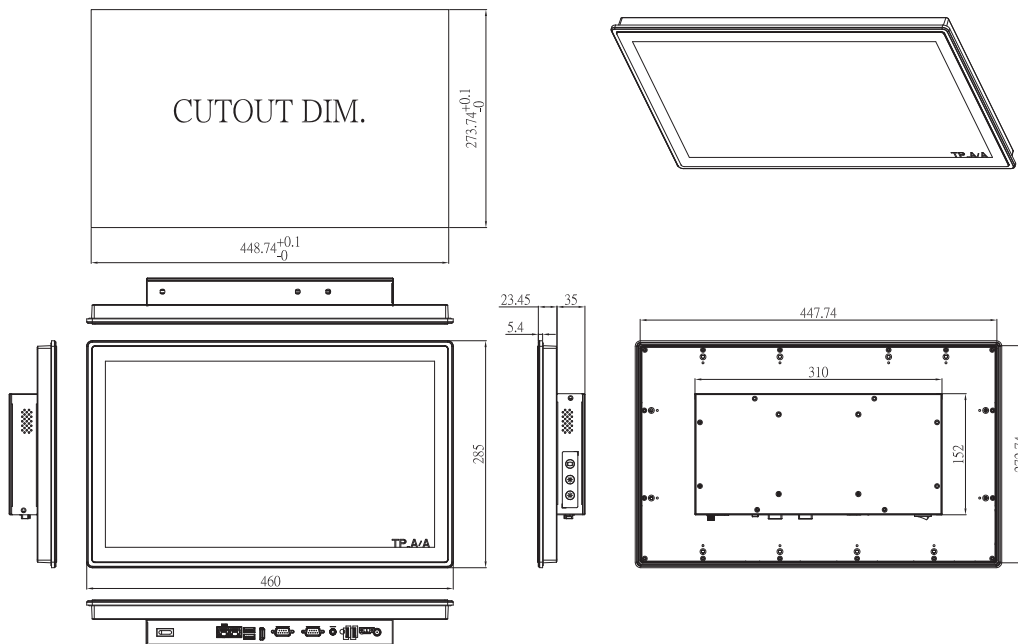

# GOT321W-502-PCT

21.5" FHD TFT Multi-touch Panel Computer with 7th/6th Gen Intel® Core™ i7/i5/i3 Processor

## Features

- 21.5" FHD 10-point multi-touch projected capacitive widescreen
- LGA1151 socket 7th/6th gen Intel® Core™ i7/i5/i3, Celeron® & Pentium® processor
- Intel® H110 chipset
- 4 USB 3.0 and 2 COM
- 2.5" SATA HDD and mSATA
- WLAN module & antenna (optional)
- IP65-rated front bezel
- Supports panel mount and VESA mount (VESA arm/desktop stand/wall mount optional)
- Built-in speakers and swappable hard drive design

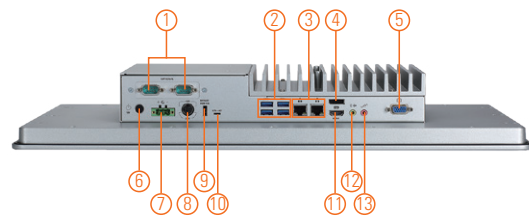
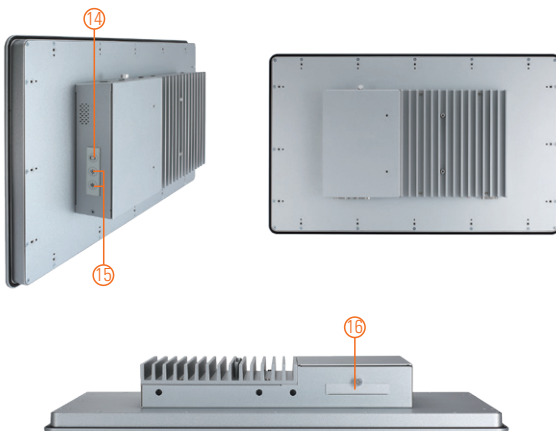
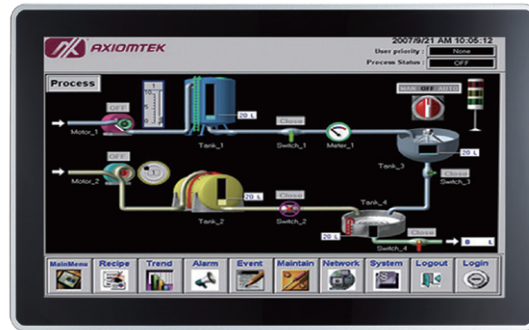

- |                    |                                      |                           |
|--------------------|--------------------------------------|---------------------------|
| 1. 2 x COM (cable) | 6. Power button (ATX)                | 11. 1 x HDMI              |
| 2. 4 x USB 3.0     | 7. Terminal block for DC power input | 12. 1 x Line-out          |
| 3. 2 x LAN         | 8. Power input for adapter           | 13. 1 x Mic-in            |
| 4. 1 x DisplayPort | 9. Remote power switch               | 14. Backlight switch      |
| 5. 1 x VGA         | 10. AT/ATX selectable switch         | 15. Brightness adjust +/- |
|                    |                                      | 16. Swappable HDD         |



## Introduction

The GOT321W-502-PCT is a 21.5" multi-touch panel PC for kiosk and automation applications. It has a fashionable mechanism design and industrial-grade IP61-rated front bezel which can avoid damage from chemical corrosion. To meet the demands of multimedia application, the GOT321W-502-PCT is powered by the high performance LGA1151 socket 7th/6th gen Intel® Core™ processor with the Intel® H110 chipset. It features two COM ports, two Gigabit Ethernet and up to 32GB memory of dual-channel DDR4-2400 that delivers high computing capability for high performance-demanding applications. The industrial touch panel PC is suitable for kiosk and factory automation.

### Swappable Hard Drive Design

The GOT321W-502-PCT is equipped with an easy-swappable 2.5" HDD for extensive storage needs.

### Speaker and WLAN Module Supported

The GOT321W-502-PCT is equipped with built-in speakers for multimedia applications. It also supports WLAN module and antennas (optional) for wireless network connectivity.

## Specifications

Front Bezel	Aluminum w/ IP65/NEMA 4 rugged protection	
LCD Panel	Display Type	21.5" FHD TFT
	Brightness	250 nits
	Resolution	1920 x 1080 pixels
	Viewing Angle	178°/178°
Main System	CPU	LGA1151 socket 7/6th gen Intel® Core™ i7/i5/i3, Celeron® & Pentium® processor
	Chipset	Intel® H110
	System Memory	2 x 260-pin DDR4-2400 SO-DIMM, up to 32GB
	BIOS	AMI UEFI BIOS
	Storage	1 x 2.5" SATA HDD (9.5 mm height)
	Drive	N/A
	Watchdog Timer	255 levels, 1 to 255 sec.



## Specifications

IO Connector	2 x RS-232/422/485 1 x HDMI v1.4 1 x VGA (up to 1920 x 1200 60Hz) 1 x DisplayPort v1.2 (DP++) 4 x USB 3.0 2 x 10/100/1000 Mbps Ethernet (Intel® i219-LM & i211-AT) 1 x Audio (Mic-in & Line-out)
TPM	N/A
Expansion Interface	1 x Half-size PCI Express Mini Card slot with mPCIe 1 1 x Full-size PCI Express Mini Card slot with mSATA or mPCIe 2
Touchscreen	10-point projected capacitive multi-touch
Power Supply	DC terminal block: +12V/+19V/+24V AC adapter: 19V, 6.32A
Power Consumption	105W
Dimensions	547.59 mm (21.56") (W) x 339.05 mm (13.49") x 75.6 mm (2.98")
Packing Dimensions	720 mm (28.34") (W) x 210 mm (8.27") (D) x 550 mm (2.17") (H)
Weight (net/gross)	8.4 kg (18.5 lb)/11.3 kg (24.9 lb)
Operating Temperature	0°C to +40°C (+32°F to +104°F)
Relative Humidity	10% to 90% @ +40°C, non-considering
Operating Vibration	1.0G, 5 - 500Hz, random
Certifications	CE

## Packing List

1 x GOT321W-502-PCT
1 x Driver CD
1 x Phoenix connector
1 x Panel mount kit
1 x Adapter

## Dimensions

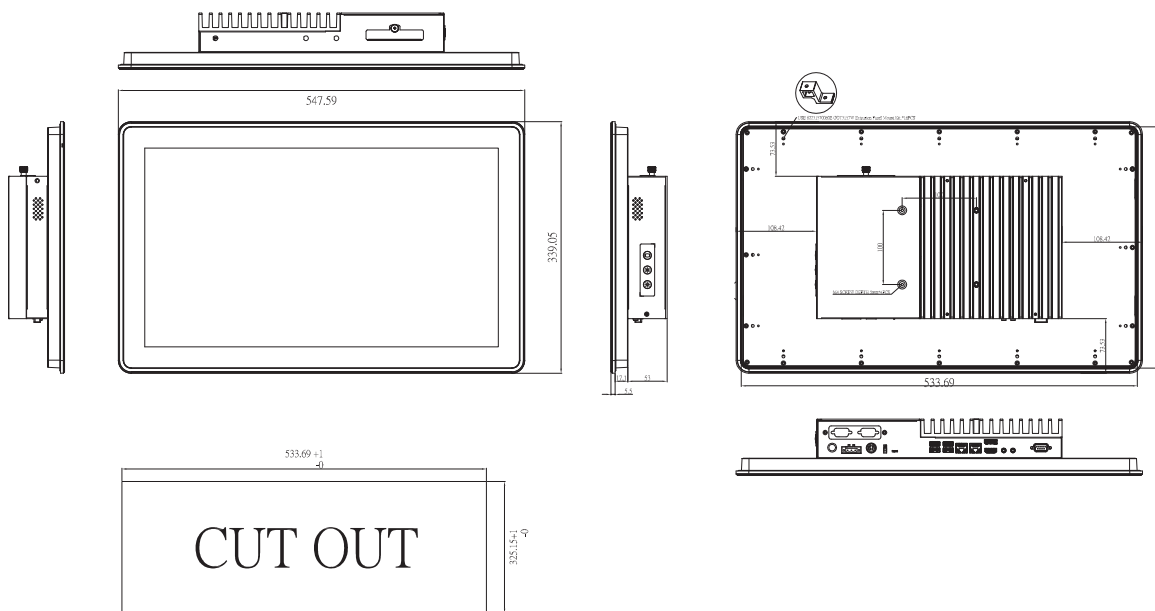

## Ordering Information

GOT321W-502-PCT	21.5" FHD TFT fanless multi-touch panel computer with LGA1151 socket 7th/6th gen Intel® Core™ Pentium®, Celeron® processor, 10-point projected capacitive multi-touch screen and 12/19/24 VDC terminal block connector
-----------------	--

\* Specification and certifications are based on requirements and may vary.

## Optional Accessories

Wi-Fi + Bluetooth kit	
82231770050E	GOT3177T-834 wall mount kit

## Optional EOS Installation

Windows® 7
Windows® 8.1
Windows® 10 IoT Enterprise

## Optional OS Installation

Skylake: Windows® 7
Windows® 8.1
Windows® 10
Kaby Lake: Windows® 10

# GOT3217WL-845-PCT

21.5" FHD TFT Multi-touch Panel Computer with Intel® Pentium® Processor N3710

## Features

- 21.5" FHD 10-point multi-touch projected capacitive widescreen
- Fanless design with Intel® Pentium® processor N3710
- 2.5" 7/9.5 mm SATA HDD & mSATA
- 3G, WLAN module & antennas (optional)
- 2 GbE LANs, 2 USB 3.0, 2 USB 2.0 and 2 COM
- IP65-rated aluminum front bezel
- Supports panel mount and VESA mount (VESA arm/desktop stand/wall mount optional)
- Adjustable RS-232/422/485 setting via BIOS

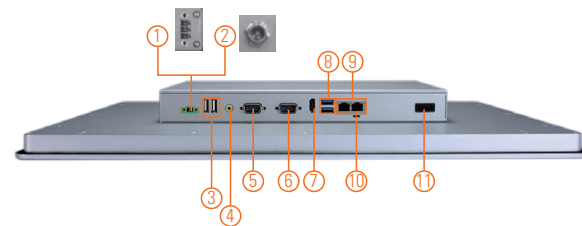
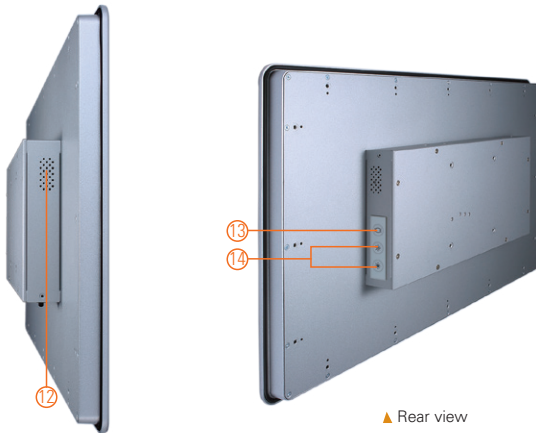

- |  |                              |                           |
|--|------------------------------|---------------------------|
| 1. Terminal block for DC power input or  | 6. 1 x RS-232                | 11. Power Switch (ATX)    |
| 2. Screw connector with AC power adapter | 7. 1 x HDMI                  | 12. Speaker               |
| 3. 2 x USB 2.0                           | 8. 2 x USB 3.0               | 13. Backlight switch      |
| 4. 1 x Line-out                          | 9. 2 x LAN                   | 14. Brightness adjust +/- |
| 5. 1 x RS-232/422/485                    | 10. AT/ATX selectable switch |                           |



## Introduction

The GOT3217WL-845-PCT adopts a 21.5-inch FHD LCD and supports low power Intel® Pentium® processor N3710. It also provides two PCI Express Mini card slots for 3G, wireless network connectivity. This 21.5" multi-touch panel computer is suitable for transportation, heavy-duty industry, smart factory automation, and oil pipe monitoring systems.

### 21.5-inch FHD LCD with Projected Capacitive Multi-touch

The 21.5" FHD touch panel PC has a 21.5-inch FHD TFT LCD display with a 10-point multi-touch screen and 250 nits of brightness. The hardness of touch glass surface is up to 7h for anti-scratch purpose.

### WLAN Antenna Supported (optional)

The GOT3217WL-845-PCT provides two PCI Express Mini card slots and WLAN antennas for 3G and wireless network connectivity.

## Specifications

Front Bezel	IP65 front bezel	
LCD Panel	Display Type	21.5" FHD TFT LCD
	Brightness (cd/m <sup>2</sup> )	250 nits
	Resolution	1920 x 1080
Main System	CPU	Intel® Pentium® processor N3710 4C @ 1.6 GHz (Braswell)
	Chipset	SoC integrated
	System Memory	1 x 204-pin DDR3L-1333/1600 SO-DIMM, up to 8GB
	BIOS	AMI UEFI BIOS
	Storage	1 x 2.5" SATA HDD (9.5 mm height) 1 x mSATA
	Watchdog Timer	255 levels, 0 to 255 sec.
	Onboard Graphics	Integrated Intel® HD Graphics

## Specifications

I/O Connector	1 x RS-232 1 x RS-232/422/485 1 x Switch for power on/off (ATX) 1 x Audio (Line-out) 2 x USB 3.0 2 x USB 2.0 2 x 10/100/1000 Mbps Ethernet (Intel® i217-LM & i210-AT)
TPM	N/A
Expansion Interface	1 x Full-size PCI Express Mini Card slot with mSATA 1 x Full-size PCI Express Mini Card slot with SIM
Touchscreen	10-point projected capacitive multi-touch
Power Supply	1. DC version: 24 VDC 2. AC version: 12 VDC 60W adapter
Power Consumption	48W
Dimensions	547.6 mm (21.56") (W) x 58.5 mm (2.30") (D) x 339.0 mm (13.35") (H)
Packing Dimensions	720 mm (28.34") (W) x 210 mm (8.27") (D) x 550 mm (2.17") (H)
Weight (net/gross)	7.6 kg (16.8 lb)/10.5 kg (23.1 lb)
Operating Temperature	0°C to +50°C (+32°F to +122°F)
Relative Humidity	20% to 90% @ +40°C; non-condensing
Operation Vibration	1G, 10 - 500 Hz, random for 2.5" SATA HDD
Certifications	CE

## Packing List

- 1 x GOT3217WL-845-PCT
- 1 x Driver CD
- 1 x Adapter (GOT3217WL-845-PCT-J)
- 1 x Phoenix connector (GOT3217WL-845-PCT-DC, 24 VDC)
- 1 x Panel mount kit

## Dimensions

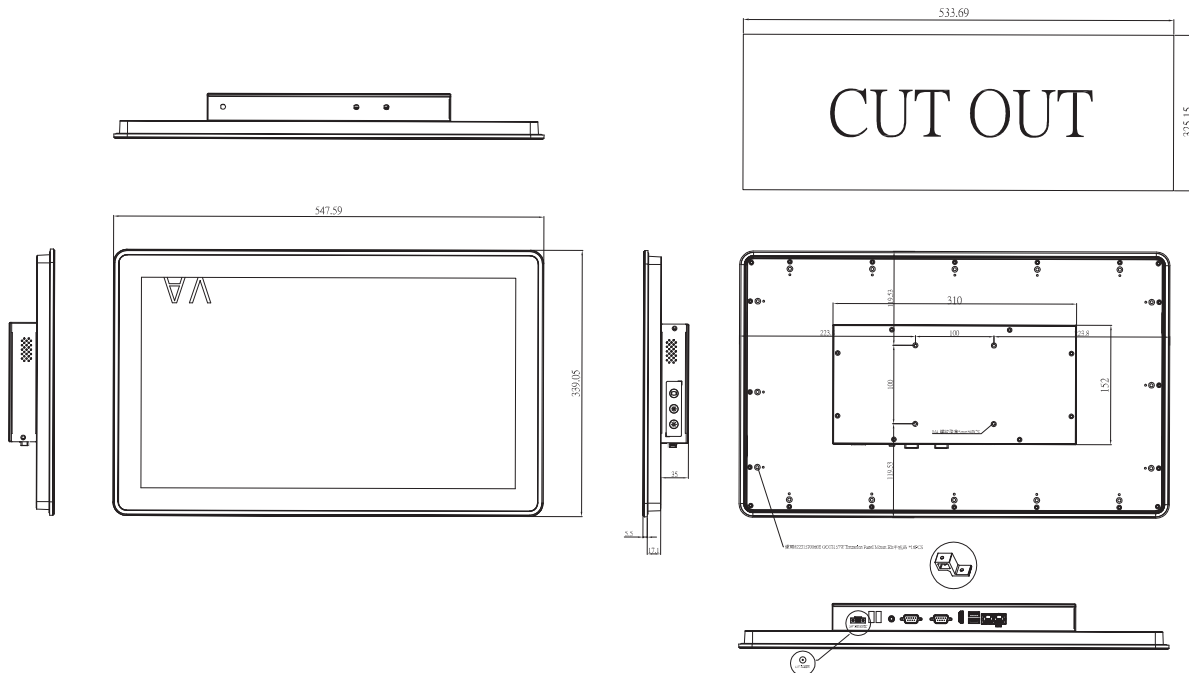

## Ordering Information

GOT3217WL-845-PCT-J	21.5" FHD TFT fanless touch panel computer with Intel® Pentium® N3710 1.6 GHz quad core processor, 10-point projected capacitive multi-touch screen and AC-DC 12 VDC power adapter (screw type connector)
GOT3217WL-845-PCT-DC	21.5" FHD TFT fanless touch panel computer with Intel® Pentium® N3710 1.6 GHz quad core processor, 10-point projected capacitive multi-touch screen and 24 VDC terminal block connector

## Optional Accessories

Wi-Fi + Bluetooth + 4G	
82231770050E	GOT3177T-834 wall mount kit
50906D24000E	Adaptor 24V/120W, wire only, FSP120-AAAN3 (for DC model)

\* Specifications and certifications may vary based on different requirements.

## Optional EOS Installation

Windows® 10 IoT Enterprise

## Optional OS Installation

Windows® 10

# 3

## Vehicle Mount Terminal Computer

Axiomtek's GOT600 series provides IP65-rated for full system, and auto-dimming function base on different environment; the operability at a sild operating temperatures from -30°C to +55°C. With class 5M3/MIL-STD 810F for vibration and chock test, the GOT600 series defines as vehicle mount terminal focuses on logistics, automation and heavy-duty markets, especially in the case of forklifts.

Selection Guide	274
GOT610-837 10.4" XGA Fanless Touch Panel PC with Intel® Atom® Processor E3845 1.91 GHz for Heavy-duty Vehicle [-30°C to +55°C]	275

# Industrial Panel PCs

# Vehicle Mount Terminal Computer

## Selection Guide



Features/Models	GOT610-837
<b>CPU Level</b>	Intel® Atom® E3845 1.91 GHz (Bay Trail)
<b>Chipset</b>	SoC intergrated
<b>System Memory</b>	DDR3 4GB (default) or 8GB memory onboard
<b>Display</b>	10.4" XGA TFT LCD, 500 nits
<b>I/O</b>	1 x 10/100/1000 Mbps Ethernet with isolated 1.5KV 4 x USB port type A connector 1 x RS-232/422/485 with isolated 1.5KV D-sub 9 male 1 x DC for power input with isolated 1.5KV Phoenix 3.81 mm terminal 1 x Audio: Line-out, Mic-in 1 x DIO (6-in/2-out) with isolated 1.5KV Phoenix type 1 x CANbus with isolated 1.5KV D-sub 9 male 3 x Internal Antenna (SMA) 1 x SIM Card socket
<b>Storage</b>	16GB flash onboard 1 x mSATA
<b>Expansion Interface</b>	2 x Full-size PCI Express Mini Card slot
<b>Touchscreen</b>	5-wire resistive touch Projected Capactive Touch
<b>Operating System</b>	Windows® 7, WES7 Windows® 8/8.1, WEBS Windows® 10, Windows® 10 IoT
<b>Power Supply</b>	9 to 60 VDC
<b>Power Consumption</b>	44.5W
<b>Watchdog Timer</b>	255 levels, 1 to 255 sec
<b>Front Bezel</b>	Aluminum with rugged protection
<b>Dimensions (W x D x H)</b>	382 x 185 x 427 mm (15.04" X 7.28" X 16.81")
<b>Weight (net/gross)</b>	TBC
<b>Operating Temperature</b>	-30°C to +55°C (-22°F to +131°F)
<b>Certifications</b>	CE, EN 60721-3-5

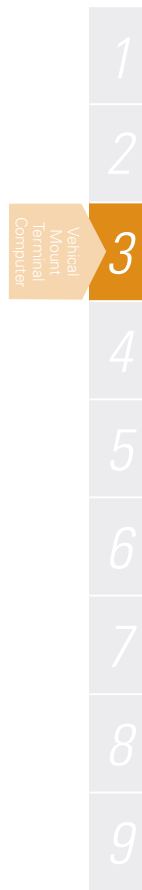

# GOT610-837

10.4" XGA Fanless Touch Panel PC with Intel® Atom® Processor E3845 1.91 GHz for Heavy-duty Vehicle (-30°C to +55°C)

## Features

- Intel® Atom® processor E3845 1.91 GHz
- Auto-dimming for different environment
- Specially designed by vehicle mount terminals
- Front hot keys with quick setting
- Wide operating temperature range from -30°C to +55°C
- Various mounting ways
- Wireless connectivity available up to 5 devices
- Class 5M3 and MIL-STD 810F for vibration/shock resistance



▲ Side view

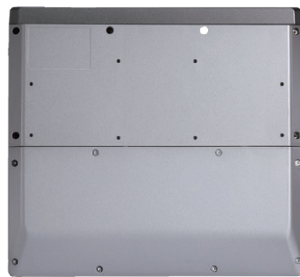

▲ Rear view



1. Multi-function key
2. Brightness +/-
3. Volume +/-
4. LCD on/off
5. LED indicator
6. LED light sensor

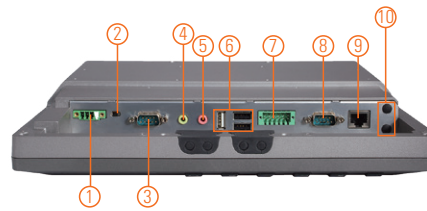

1. DC-in
2. AX/ATX mode switch
3. CANBus
4. 1 x Line-out
5. 1 x Mic-in
6. 3 x USB 2.0 type A
7. DIO (6-in/2-out)
8. 1 x RS-232/422/485
9. 1 x LAN
10. 2 x Wireless antenna hole



## Introduction

The GOT610-837 vehicle mount terminal focuses on logistics, automation and heavy-duty markets. The GOT610-837 has advanced the platform to meet the daily challenges and demanding work environments of warehouses and distribution center. The GOT610-837 is in use to improve efficiencies across the facility. Especially in the case of forklifts, embedding a capable mobile terminal can improve productivity and reduce errors from the docks to the yard. Having access to accurate information at all time in real-time aids in every process from receiving to storing, moving around, cross docking and picking. Axiomtek serves the needs of supply chain operations to meet any harsh conditions.

### Wide Operating Temperature

The Intel® Atom®-based forklift panel PC, GOT610-837, applies unique extended temperature technology with wide temperature range support as well as fanless operation. It also has a compact design for transport heavy-duty environment.

### Designed for Vehicle Markets

The Axiomtek GOT610-837 is particularly suitable for demanding HMI applications in the vehicle-mounted sector, including arranging stocks and picking goods up and away. To ensure the reliable operation in a variety of different locations, the 10.4-inch vehicle-mounted panel PC supports various mounting options: wall mount, VESA arm and desktop stand. Moreover, it is also ready for Windows® 10, 8.1 or 7.

## Specifications

Front Bezel	IP65, NEMA 4 rugged protection, aluminum front bezel	
LCD Panel	Display Type	10.4" XGA TFT LCD
	Brightness (cd/m <sup>2</sup> )	500 nits
	Resolution	1024 x 768
	Viewing Angle (H/V)	176°/176°
Main System	CPU	Intel® Atom® processor E3845 1.91 GHz (Bay Trail)
	Chipset	SoC integrated
	System Memory	DDR3 4GB (default) or 8GB memory onboard
	BIOS	AMI with Axiomtek standard features; such as SmartView, Ethernet Boot ROM (RPL & PXE), customer CMOS backup
	Storage	16GB flash onboard 1 x mSATA
	Watchdog Timer	255 levels, 1 to 255 sec.
	Onboard Graphics	Integrated in Intel® GFX



## Specifications

I/O Connector	1 x 10/100/1000 Mbps Ethernet with isolated 1.5KV 4 x USB (type A) 1 x RS-232/422/485 with isolated 1.5KV (D-sub 9 male) 1 x DC for power input with isolated 1.5KV 1 x Audio (Line-out & Mic-in) 1 x DIO (6-in/2-out) with isolated 1.5KV 1 x CAN bus with isolated 1.5KV 3 x Internal antenna (SMA) 1 x SIM socket
Expansion Interface	2 x PCI Express Mini Card slot
Flat Panel	5-wire resistive or projected capacitive touch
Power Supply	9 to 60 VDC
Power Consumption	44.5 W
Dimensions	291 mm (11.46") (W) x 265.88 mm (10.47") (D) x 50 mm (1.97") (H)
Packing Dimensions	382 mm (15.04") (W) x 185 mm (7.28") (D) x 427 mm (16.81") (H)
Weight (net)	2.05 kgs (4.52 lb)
Operating Temperature	-30°C to +55°C (-22°F to +131°F)
Relative Humidity	10% to 95% @ 40°C, non-condensing
Certifications	EN 60721-3-5, full IP65

\* W.T.: Wide Temperature. All W.T. supported products have to be sorted by Axiomtek.

## Packing List

- 1 x GOT610-837 unit
- 1 x Driver CD
- 2 x Phoenix connector (1 x power 4-pin/1 x DIO 12-pin)

## Ordering Information

GOT610-837	10.4" XGA fanless touch panel computer with Intel® Atom® E3845, 5-wire resistive touch screen and 9 to 60 VDC power input
------------	---

Specifications and certifications may vary based on different requirements.

## Optional EOS Installation

WES 7	
WE8S	
Windows® 10 IoT	

## Optional OS Installation

Windows® 7	
Windows® 8/8.1	
Windows® 10	

## Dimensions

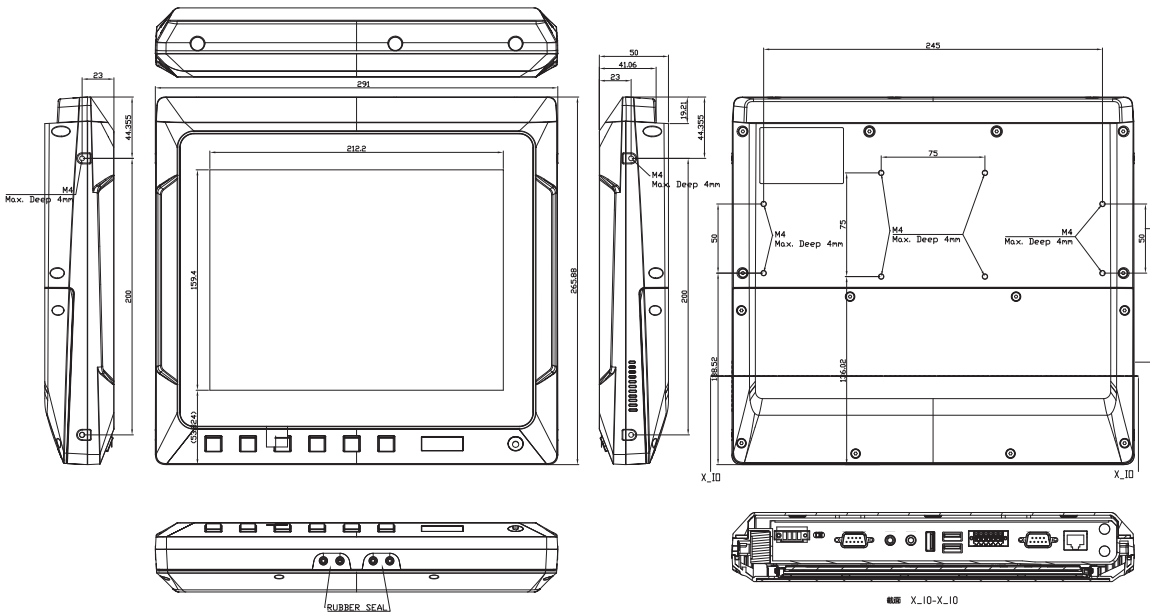



Fanless Touch Panel Computers

Heavy-duty Fanless Touch Panel Computers

Vehicle Mount Terminal Computer

Stainless Touch Panel Computers

Transportation Touch Panel Computers and Displays

Industrial Touch Panel Computers

Industrial Touch Monitors

Medical Panel Computers

Open Frame Panel Computer

# Industrial Panel PCs

# 4

## Stainless Touch Panel Computers

The GOT800 series is specifically designed for dusty or wet spaces in food factories or kitchen and low temperature environments such as cold storage warehouses. This product line provides an IP66-rated or IP69K-rated housing option, the brightness for readability under the sunlight, and the operability at a wide range of temperature from -20°C to +55°C.

Selection Guide		279
GOT812L(H)-880	12.1" XGA TFT IP66 & IP69K-rated Stainless Steel Fanless PCT (or Resistive Touch) Panel Computer with Intel® Core™ i5 Processor and Flat Bezel Design (-20°C to +50°C)	281
GOT812LR-834	12.1" XGA TFT IP66-rated Stainless Steel Fanless Touch Panel Computer with Intel® Atom® Processor E3827 and High Brightness (-20°C to +55°C)	283
GOT815L-511	15" XGA TFT IP66 & IP69K-rated Stainless Steel Fanless PCT (or Resistive Touch) Panel Computer with Intel® Core™ i5-7300U Processor and Flat Bezel Design (-20°C to +50°C)	285
GOT815-834	15" XGA TFT IP66 & IP69K-rated Stainless Steel Fanless PCT (or Resistive Touch) Panel Computer with Intel® Atom® Processor E3827 and Flat Bezel Design (-20°C to +55°C)	287
GOT817L-511	17" SXGA TFT IP66 & IP69K-rated Stainless Steel Fanless PCT (or Resistive Touch) Panel Computer with Intel® Core™ i5-7300U Processor and Flat Bezel Design (-20°C to +50°C)	289
GOT817-834	17" SXGA TFT IP66 & IP69K-rated Stainless Steel Fanless PCT (or Resistive Touch) Panel Computer with Intel® Atom® Processor E3827 and Flat Bezel Design (-20°C to +55°C)	291

# Stainless Touch Panel Computers

## Selection Guide



Features/Models	GOT812L(H)-880	GOT812LR-834	GOT815L-511
<b>CPU Level</b>	Intel® Core™ i5 4300U 1.9 GHz (Haswell ULT)	Intel® Atom® E3827 (1.75 GHz)	Intel® Core™ i5-7300U 3.5 GHz (Kaby Lake)
<b>Chipset</b>	SoC intergrated	SoC intergrated	SoC integrated
<b>System Memory</b>	1 x 204-pin SO-DIMM DDR3L-1600, up to 8GB	1 x 204-pin SO-DIMM DDR3L-1333, up to 8GB	1 x 260-pin DDR4-2133 SO-DIMM, up to 16GB
<b>Display</b>	12" XGA TFT, 500 nits (GOT812L-880) 12" XGA TFT, 800 nits (GOT812H-880)	12.1" XGA TFT, 1000 nits	15" XGA TFT LCD, 420 nits
<b>I/O</b>	2 x RS-232/422/485 (default RS-232) 4 x USB 2.0 1 x 10/100/1000 Mbps Ethernet	2 x RS-232/422/485 (default RS-232) 2 x USB 2.0 1 x 10/100/1000 Mbps Ethernet	2 x RS-232/422/485 (default RS-232, A-coded) 4 x USB 2.0 (A-coded) 1 x 10/100/1000 Mbps Ethernet
<b>Storage</b>	1 x 2.5" SSD	1 x 2.5" SSD 1 x CFast™	1 x 2.5" SSD HDD or 1 x 2.5" SATA HDD
<b>Expansion Interface</b>	1 x PCI Express Mini Card slot	2 x PCI Express Mini Card slot	1 x Full-size PCI Express Mini Card slot 1 x Half-size PCI Express Mini Card slot
<b>Touchscreen</b>	5-wire resistive type or projected capacitive touch	2-wire low reflective resistive type	5-wire resistive touch or projected capacitive multi-touch
<b>Operating System</b>	Windows® 8.1, WE8S, Windows® 7, WES 7, Windows® 10	Windows® 8.1, WE8S, Windows® 7, WES 7, Windows® 10	Windows® 10 IoT, Windows® 10
<b>Power Supply</b>	9 to 36 VDC	9 to 36 VDC	9 to 36 VDC
<b>Power Consumption</b>	56W	47W	45W
<b>Watchdog Timer</b>	255 levels, 1 to 255 sec.	255 levels, 1 to 255 sec.	255 levels, 1 to 255 sec.
<b>Front Bezel</b>	Stainless steel with IP66/IP69K protection	Stainless steel with full IP66 protection	Stainless steel IP66/IP69K protection
<b>Dimensions (W x D x H)</b>	318 x 75.3 x 248.5 mm (12.52" x 2.96" x 9.78")	296 x 240 x 59 mm (11.65" x 9.45" x 3.74" )	382 x 55 x 305 mm (15.4" x 2.17" x 12.01")
<b>Weight (net/gross)</b>	4.27 kg (9.41 lb)/5.77 kg (12.72 lb)	4.6 kg (10.14 lb)/6.2 kg (13.67 lb)	5.2 kg (11.46 lb)/8.4 kg (18.5 lb)
<b>Operating Temperature</b>	-20°C to +50°C (-4°F to +122°F)	-20°C to +55°C (-4°F to +131°F)	-20°C to +50°C (-4°F to +122°F)
<b>Certifications</b>	CE	CE	CE



Features/Models	GOT815-834	GOT817L-511	GOT817-834
<b>CPU Level</b>	Intel® Atom® E3827 1.75 GHz	Intel® Core™ i5-7300U 3.5 GHz (Kaby Lake)	Intel® Atom® E3827 1.75 GHz
<b>Chipset</b>	SoC integrated	SoC integrated	SoC integrated
<b>System Memory</b>	1 x 204-pin DDR3L-1333 SO-DIMM, up to 8GB	1 x 260-pin DDR4-2133 SO-DIMM, up to 16GB	1 x 204-pin DDR3L-1333 SO-DIMM, up to 8GB
<b>Display</b>	15" XGA TFT, 420 nits	17" SXGA TFT LCD, 350 nits	17" SXGA TFT, 350 nits
<b>I/O</b>	2 x RS-232/422/485 (default RS-232) 4 x USB 2.0 1 x 10/100/1000 Mbps Ethernet	2 x RS-232/422/485 (default RS-232, A-coded) 4 x USB 2.0 (A-coded) 1 x 10/100/1000 Mbps Ethernet	2 x RS-232/422/485 (default RS-232) 4 x USB 2.0 1 x 10/100/1000 Mbps Ethernet
<b>Storage</b>	1 x 2.5" SSD 1 x CFast™	1 x 2.5" SSD HDD or 1 x 2.5" SATA HDD	1 x 2.5" SSD 1 x CFast™
<b>Expansion Interface</b>	2 x PCI Express Mini Card slot	1 x Full-size PCI Express Mini Card slot 1 x Half-size PCI Express Mini Card slot	2 x PCI Express Mini Card slot
<b>Touchscreen</b>	5-wire resistive type or projected capacitive touch	5-wire resistive touch or projected capacitive multi-touch	5-wire resistive type or projected capacitive touch
<b>Operating System</b>	Windows® 8.1, WE8S, Windows® 7, WES 7, Windows® 10	Windows® 10 IoT, Windows® 10	Windows® 8.1, WE8S, Windows® 7, WES 7, Windows® 10
<b>Power Supply</b>	9 to 36 VDC	9 to 36 VDC	12 to 36 VDC
<b>Power Consumption</b>	30W	67.5W	50W
<b>Watchdog Timer</b>	255 levels, 1 to 255 sec.	255 levels, 1 to 255 sec.	255 levels, 1 to 255 sec.
<b>Front Bezel</b>	Stainless steel with IP66/IP69K protection	Stainless steel IP66/IP69K protection	Stainless steel IP66/IP69K protection
<b>Dimensions (W x D x H)</b>	382 x 55 x 305 mm (15.4" x 2.2" x 12.01")	415.92 x 55 x 348.34 mm (16.37" x 2.16" x 13.71")	415.92 x 54.96 x 348.34 mm (16.37" x 2.16" x 13.71")
<b>Weight (net/gross)</b>	6.94 kgs (15.3 lb)/10.2 kgs (22.5 lb)	6.94 Kgs (15.3 lb) / 10.2 Kgs (22.5 lb)	7.04 kg (15.52 lb) / 10.3 kg (22.71 lb)
<b>Operating Temperature</b>	-20°C to +50°C (-4°F to +122°F)	-20°C to +50°C (-4°F to +122°F)	-20°C to +55°C (-4°F to +131°F)
<b>Certifications</b>	CE	CE	CE

Stainless Touch Panel Computers

- 1
- 2
- 3
- 4
- 5
- 6
- 7
- 8
- 9

# GOT812L(H)-880

12.1" XGA TFT IP66 & IP69K-rated Stainless Steel Fanless PCT (or Resistive Touch) Panel Computer with Intel® Core™ i5 Processor and Flat Bezel Design (-20°C to +50°C)

## Features

- 12.1" XGA TFT flat bezel LCD display
- Sunlight readable solution with 800 nits of brightness
- IP66/IP69K-rated (NEMA 4X) water/dust/corrosion-proof design
- Full stainless steel enclosure with type 316
- -20°C to +50°C wide operating temperature range
- Fanless design with Intel® Core™ i5 processor
- Optional Wi-Fi/3G kit for wireless network connectivity
- 9 to 36 VDC wide range power input
- M12 type connectors for harsh environments



▲ Side view

1. Backlight on/off
2. Brightness adjust +/-
3. Power on/off

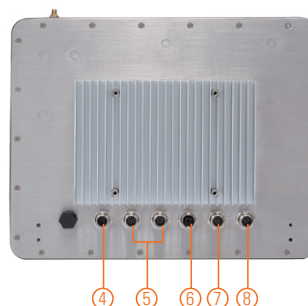

4. DC power connector
5. 4 x USB 2.0
6. 1 x LAN
7. 1 x RS-232/422/485 (default: RS-232)
8. 1 x RS-232



## Introduction

The 12-inch GOT812L(H)-880 is specially designed for food processing applications. Its IP66-rated stainless steel housing protects entire system from damage of water, powder and dust. It also supports a wide operating temperature range from -20°C to +50°C. Thus, this robust unit is specifically designed for high humidity, dusty or wet spaces in food factories or kitchens and more harsh applications.

### Sunlight Readable Design

The GOT812L(H)-880 features sunlight readable technology with 800 nits of brightness and low reflective touchscreen allows the screen legible even under strong sunlight.

### Full IP66 and IP69K Certified

The GOT812L(H)-880 adopts a water/dust-proof housing design with five IP66-rated connectors, M12 I/O connectors and IP69K that ensures the product's ability to resist ingress of high temperature and high pressure water. It passed entire system IP66 test by SGS and verified salt mist test. Additionally, it was tested by a spray nozzle with high temperature water (+80°C), a flow rate of 14 to 16 L/min and a nozzle hold with distance 10 to 15 cm away from the device at angles of 0°, 30°, 60° and 90° for 30 seconds. The GOT812L(H)-880 is qualified to meet harsh environment applications.

### Wide Temp. (-20°C to +50°C) & Anti-vibration (2G) Design

The GOT812L(H)-880 featuring fanless and noiseless design supports a wide operating temperature range from -20°C to +50°C. Besides, the patent of anti-vibration for SSD ensures system reliability and stability.

## Specifications

Enclosure	Stainless type 316	
LCD Panel	Display Type	12.1" XGA TFT LCD
	Brightness (cd/m <sup>2</sup> )	800 nits LCD (GOT812H-880) 500 nits LCD (GOT812L-880)
	Resolution	1024 x 768
	Viewing Angle (H/V)	160°/160°
Main System	CPU	Intel® Core™ i5 4300U 1.9 GHz (Haswell ULT)
	Chipset	SoC integrated
	System Memory	1 x 204-pin DDR3L-1600 SO-DIMM, up to 8GB
	BIOS	AMI with Axiomtek standard features; such as, SmartView, Ethernet Boot ROM (RPL & PXE), customer CMOS backup
	Storage	1 x 2.5" SSD
	Watchdog Timer	255 levels, 1 to 255 sec.
	Onboard Graphics	Integrated in Intel® GFX



## Specifications

I/O Connector	2 x RS-232/422/485 (default RS-232, A-coded) 4 x USB 2.0 (A-coded) 1 x 10/100/1000 Mbps Ethernet (Intel® i218-LM; X-coded)
Expansion Interface	2 x PCI Express Mini Card slot
Touchscreen	5-wire resistive touch or projected capacitive multi-touch
Power Input	9 to 36 VDC
Power Consumption	56W
Dimensions	318 mm (12.52") (W) x 248.5 mm (9.78") (D) x 75.3 mm (2.96") (H)
Packing Dimensions	510 mm (20.07") (W) x 186 mm (7.32") (D) x 532 mm (20.94") (H)
Weight (net/gross)	4.27 kg (9.41 lb)/5.77 kg (12.72 lb)
Operating Temperature	-20°C to +50°C (-4°F to +122°F)
Relative Humidity	10% to 95% @ +40°C, non-condensing
Operation Vibration	2G, 5 - 500Hz, random for 2.5" SSD
Certifications	CE

\* W.T.: Wide Temperature. All W.T. supported products have to be sorted by Axiomtek.

## Packing List

1 x GOT812L(H)-880  
1 x Driver DVD  
1 x DC cable

## Dimensions

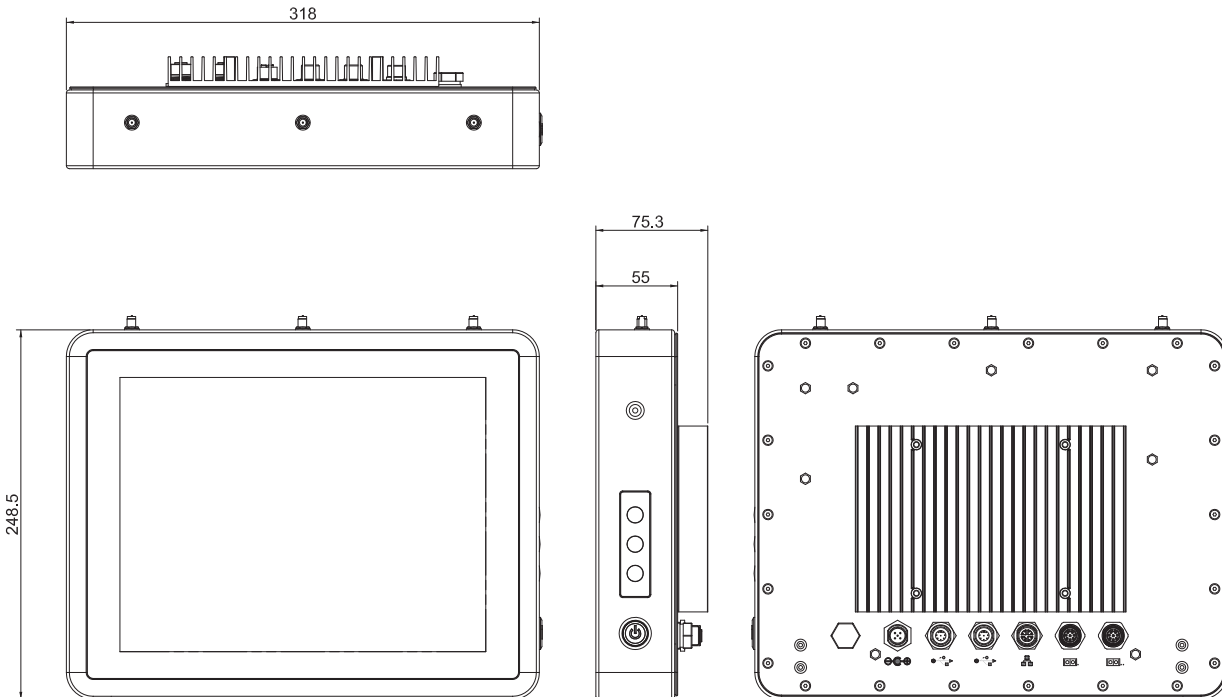

## Ordering Information

GOT812L-880-C-DC	12.1" XGA fanless IP66 & IP69K-rated stainless steel touch panel computer with Intel® Core™ i5 4300U, projected capacitive touch screen, 500 nits LCD and 9 to 36 VDC power input
GOT812L-880-C-RF-DC	12.1" XGA fanless IP66 & IP69K-rated stainless steel touch panel computer with Intel® Core™ i5 4300U, projected capacitive touch screen, 500 nits LCD, 9 to 36 VDC power input and Wi-Fi or 3G
GOT812H-880-R-DC	12.1" XGA fanless IP66 & IP69K-rated stainless steel touch panel computer with Intel® Core™ i5 4300U, 5-wire flat resistive touch screen, 800 nits LCD and 9 to 36 VDC power input
GOT812H-880-R-RF-DC	12.1" XGA fanless IP66 & IP69K-rated stainless steel touch panel computer with Intel® Core™ i5 4300U, 5-wire flat resistive touch screen, 800 nits LCD, 9 to 36 VDC power input and Wi-Fi or 3G

\*Specifications and certifications may vary based on different requirements.

## Optional Accessories

594B8122100E	Water-proof COM cable (1.8 m)
594B8152710E	Water-proof LAN cable (1.8 m)
50966D45010E	Adapter 24V 120W, M12 A-code 5P. LTE120ES
594B8122820E	Water-proof USB cable (1.8 m)
822B8120070E	GOT812 keyboard bracket (with keyboard)

## Optional EOS Installation

WES 7  
WE8S  
Windows® 10 IoT

## Optional OS Installation

Windows® 7  
Windows® 8/8.1  
Windows® 10

# GOT812LR-834

12.1" XGA TFT IP66-rated Stainless Steel Fanless Touch Panel Computer with Intel® Atom® Processor E3827 and High Brightness (-20°C to +55°C)

## Features

- Sunlight readable 12.1" TFT LCD with low reflection and high brightness (optional)
- IP66 (NEMA 4X) water/dust/corrosion-proof design
- Stainless steel front bezel enclosure with type 316
- Wide operating temperature range of -20°C to +55°C
- Fanless system with Intel® Atom® processor E3827
- Optional Wi-Fi/3G kit for wireless network connectivity
- Flexible and expandable M12 type I/O connections
- Supports suspension and VESA mount

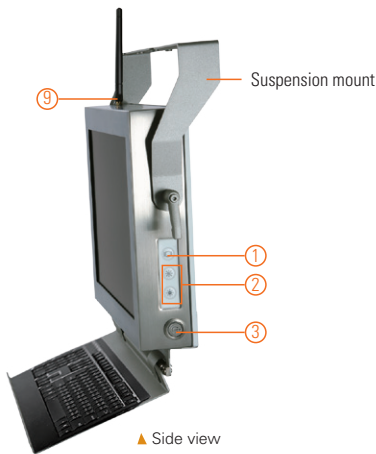

1. Backlight switch
2. Brightness adjust
3. Power switch (ATX)
4. DC power connector
5. 1 x RS-232/422/485
6. 1 x RS-232/422/485
7. 1 x LAN
8. 2 x USB 2.0
9. 3 x Wi-Fi/3G antenna  
(optional, only for RF version)



## Introduction

The 12.1-inch GOT812LR-834 is specially designed for heavy-duty & outdoor applications. Its IP66-rated stainless steel housing protects entire system from outside damage of water, powder and dust. It also supports sunlight readable technology and a wide operating temperature range of -20°C to +55°C. Thus, this robust unit is specifically designed for high humidity, dusty or wet spaces in food factories or kitchens and more harsh applications.

### IP66-Sealed System

The 12.1" GOT812LR-834 adopts a water/dust-proof housing design and five IP66-rated connectors. It passes entire system IP66 test by SGS and verified salt mist test.

### Sunlight Readable Design (optional)

Its sunlight readable technology with LED backlight and 1000 nits of brightness and low reflective touchscreen allow the screen legible even under strong sunlight.

### Wide Temperature (-20°C to +55°C) & Anti-vibration (2G) Design

The 12.1" industrial touch panel PC supports a wide operating temperature range from -20°C to +55°C. Besides, the patent of anti-vibration for SSD ensures system reliability and stability.

## Specifications

Front Bezel	Stainless type 316	
LCD Panel	Display Type	12.1" XGA TFT LCD (GOT812LR) 12.1" SVGA TFT LCD (GOT812L)
	Brightness (cd/m <sup>2</sup> )	1000 nits (GOT812LR) 500 nits (GOT812L)
	Resolution	1024 x 768 (GOT812LR) 800 x 600 (GOT812L)
	Viewing Angle (H/V)	160°/140° (GOT812LR/GOT812L)
	Main System	CPU
	Chipset	SoC integrated
	System Memory	1 x 204-pin DDR3L-1333 SO-DIMM dual channel, up to 8GB
	BIOS	AMI with Axiomtek standard features; such as, SmartView, Ethernet Boot ROM (RPL & PXE), customer CMOS backup
	Storage	1 x 2.5" SSD 1 x CFast™
	Watchdog Timer	255 levels, 1 to 255 sec.
	Onboard Graphics	Integrated in Intel® GFX

## Specifications

I/O Connector	2 x RS-232/422/485 (default RS-232) 2 x USB 2.0 1 x 10/100/1000 Mbps Ethernet (X-Coded)
Expansion Interface	2 x PCI Express Mini Card slot
Touchscreen	5-wire resistive low reflective type
Power Input	9 to 36 VDC
Power Consumption	47W
Dimensions	304 mm (11.97") (W) x 58.5 mm (2.3") (D) x 248 mm (9.76") (H)
Packing Dimensions	380 mm (14.96") (W) x 190 mm (7.48") (D) x 430 mm (16.93") (H)
Weight (net/gross)	4.6 kg (10.14 lb)/6.2 kg (13.67 lb)
Operating Temperature	-20°C to +55°C (-4°F to +131°F)
Relative Humidity	10% to 95% @ +40°C, non-condensing
Operation Vibration	2G, 5 - 500Hz, random for 2.5" SSD 2G, 5 - 500Hz, random for CompactFlash™
Certifications	CE

\* W.T.: Wide Temperature. All W.T. supported products have to be sorted by Axiomtek.

## Packing List

- 1 x GOT812LR-834
- 1 x Driver DVD
- 1 x DC cable

## Ordering Information

GOT812LR-834-DC	12.1" XGA fanless IP66-rated stainless steel touch panel computer with Intel® Atom® E3827, sunlight readable LCD (1000 nits), 5-wire resistive touch screen and 9 to 36 VDC power input
GOT812LR-834-RF-DC	12.1" XGA fanless IP66-rated stainless steel touch panel computer with Intel® Atom® E3827, sunlight readable LCD (1000 nits), 5-wire resistive touch screen, 9 to 36 VDC power input and Wi-Fi or 3G
GOT812L-834-DC	12.1" SVGA fanless IP66-rated stainless steel touch panel computer with Intel® Atom® E3827, general purpose LCD (500 nits), 5-wire resistive touch screen and 9 to 36 VDC power input
GOT812L-834-RF-DC	12.1" SVGA fanless IP66-rated stainless steel touch panel computer with Intel® Atom® E3827, general purpose LCD (500 nits), 5-wire resistive touch screen, 9 to 36 VDC power input and Wi-Fi or 3G

\*Specifications and certifications may vary based on different requirements.

## Optional Accessories

822B8120070E	GOT812 keyboard bracket (with keyboard)
822B8120080E	GOT812 suspension kit
594B8122100E	Water-proof COM cable (1.8 m)
594B8122820E	Water-proof USB cable (1.8 m)
594B8122720E	Water-proof LAN cable (1.8 m)
50966D45010E	Adapter 24V 120W. M12 A-code 5P. LTE120ES

## Optional EOS Installation

WES 7
WE8S
Windows® 10 IoT

## Optional OS Installation

Windows® 7
Windows® 8/8.1
Windows® 10

## Dimensions

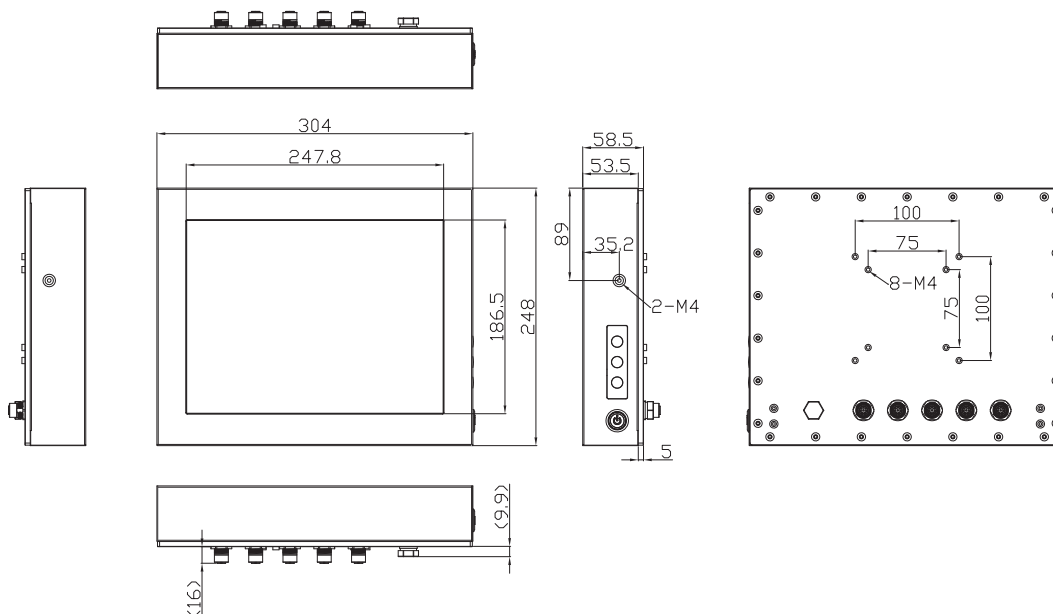

# GOT815L-511

15" XGA TFT IP66 & IP69K-rated Stainless Steel Fanless PCT (or Resistive Touch) Panel Computer with Intel® Core™ i5-7300U Processor and Flat Bezel Design (-20°C to +50°C)

## Features

- 15" XGA TFT flat bezel LCD display
- IP66/IP69K-rated (NEMA 4X) water/dust/corrosion-proof design
- Full stainless steel enclosure with type 316
- -20°C to +50°C wide operating temperature range
- Fanless design with Intel® Core™ i5-7300U processor
- Optional Wi-Fi/3G kit for wireless network connectivity
- 9 to 36 VDC wide range power input
- Supports suspension and VESA mount
- M12 type connectors for harsh environments

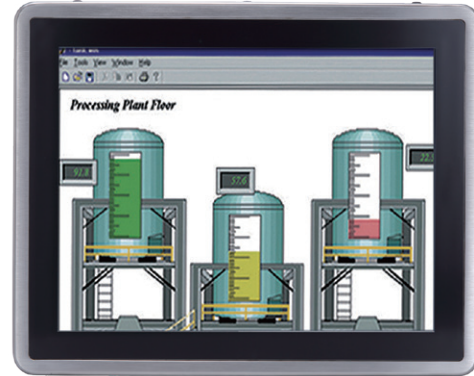

▲ Side view

1. Backlight on/off
2. Brightness adjust +/-
3. Power on/off

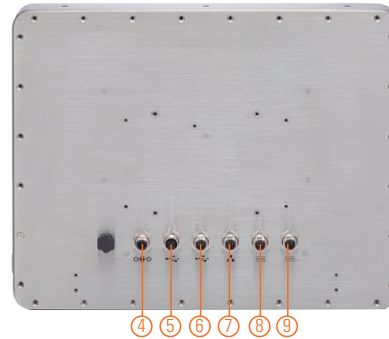

4. DC power connector
5. 1 x LAN
6. 1 x RS-232/422/485 (default RS-232)
7. 1 x RS-232/422/485 (default RS-232)
8. 2 x USB 2.0
9. 2 x USB 2.0



## Introduction

The 15-inch GOT815L-511 is specially designed for food processing applications. Its IP66-rated stainless steel housing protects entire system from damage of water, powder and dust. It also supports a wide operating temperature range from -20°C to +50°C. Thus, this robust unit is specifically designed for high humidity, dusty or wet spaces in food factories or kitchens and more harsh applications.

### Full IP66 and IP69K Certified

The GOT815L-511 adopts a water/dust-proof housing design with five IP66-rated M12 I/O connectors and IP69K that ensures the product's ability to resist ingress of high temperature and high pressure water. It passed entire system IP66 test by SGS, and verified salt mist test. Additionally, it was tested by a spray nozzle with high temperature water (+80°C), a flow rate of 14 to 16 L/min and a nozzle hold with distance 10 to 15 cm away from the device at angles of 0°, 30°, 60° and 90° for 30 seconds. The GOT815L-511 is qualified to meet harsh environment applications.

### Wide Temp. (-20°C to +50°C) & Anti-vibration (1G) Design

The GOT815L-511 featuring fanless and noiseless design supports a wide operating temperature range from -20°C to +50°C. Besides, the patent of anti-vibration for SSD ensures system reliability and stability.

## Specifications

Enclosure	Stainless type 316	
LCD Panel	Display Type	15" XGA TFT LCD
	Brightness (cd/m <sup>2</sup> )	420 nits LCD
	Resolution	1024 x 768
	Viewing Angle (H/V)	160°/160°
Main System	CPU	Intel® Core™ i5-7300U 3.5 GHz (Kaby Lake)
	Chipset	SoC integrated
	System Memory	1 x 260-pin DDR4-2133 SO-DIMM, up to 16GB
	BIOS	AMI UEFI BIOS
	Storage	1 x 2.5" SSD HDD or 1 x 2.5" SATA HDD (9.5 mm height)
	Watchdog Timer	255 levels, 1 to 255 sec.
	Onboard Graphics	Integrated in Intel® GFX

## Specifications

I/O Connector	2 x RS-232/422/485 (default RS-232, A-coded) 4 x USB 2.0 (A-coded) 1 x 10/100/1000 Mbps Ethernet with Intel® i210-IT (X-coded); support Wake-on-LAN, PXE Boot ROM
Expansion Interface	1 x Full-size PCI Express Mini Card slot 1 x Half-size PCI Express Mini Card slot
Touchscreen	5-wire resistive touch or projected capacitive multi-touch
Power Input	9 to 36 VDC
Power Consumption	45W
Dimensions	382 mm (15.4") (W) x 55 mm (2.17") (D) x 305 mm (12.01") (H)
Packing Dimensions	510 mm (20.07") (W) x 186 mm (7.32") (D) x 532 mm (20.94") (H)
Weight (net/gross)	5.2 kg (11.46 lb)/8.4 kg (18.5 lb)
Operating Temperature	-20°C to +50°C (-4°F to +122°F)
Relative Humidity	10% to 95% @ +40°C, non-condensing
Operation Vibration	1G, 5 - 500Hz, random for 2.5" SSD
Certifications	CE

\*W.T.: Wide temperature. All W.T. supported products have to be sorted by Axiomtek.

## Packing List

1 x GOT815L-511  
1 x Driver DVD  
1 x DC cable

## Ordering Information

GOT815L-511-C-DC	15" XGA fanless IP66 & IP69K-rated stainless steel touch panel computer with Intel® Core™ i5-7300U, projected capacitive touch screen, 420 nits LCD and 9 to 36 VDC power input
GOT815L-511-C-RF-DC	15" XGA fanless IP66 & IP69K-rated stainless steel touch panel computer with Intel® Core™ i5-7300U, projected capacitive touch screen, 420 nits LCD, 9 to 36 VDC power input and Wi-Fi/3G
GOT815L-511-R-DC	15" XGA fanless IP66 & IP69K-rated stainless steel touch panel computer with Intel® Core™ i5-7300U, 5-wire flat resistive touch screen and 9 to 36 VDC power input
GOT815L-511-R-RF-DC	15" XGA fanless IP66 & IP69K-rated stainless steel touch panel computer with Intel® Core™ i5-7300U, 5-wire flat resistive touch screen, 9 to 36 VDC power input and Wi-Fi/3G

## Optional Accessories

594B8122100E	Water-proof COM cable (1.8 m)
594B8152710E	Water-proof LAN cable (1.8 m)
594B8152820E	Water-proof USB cable (1.8 m)
50966D45010E	Adapter 24V 120W, M12 A-code 5P, LTE120ES
822B8120070E	GOT812 keyboard bracket (with keyboard)

\*Specifications and certifications may vary based on different requirements.

## Optional EOS Installation

Windows® 10 IoT

## Optional OS Installation

Windows® 10

## Dimensions

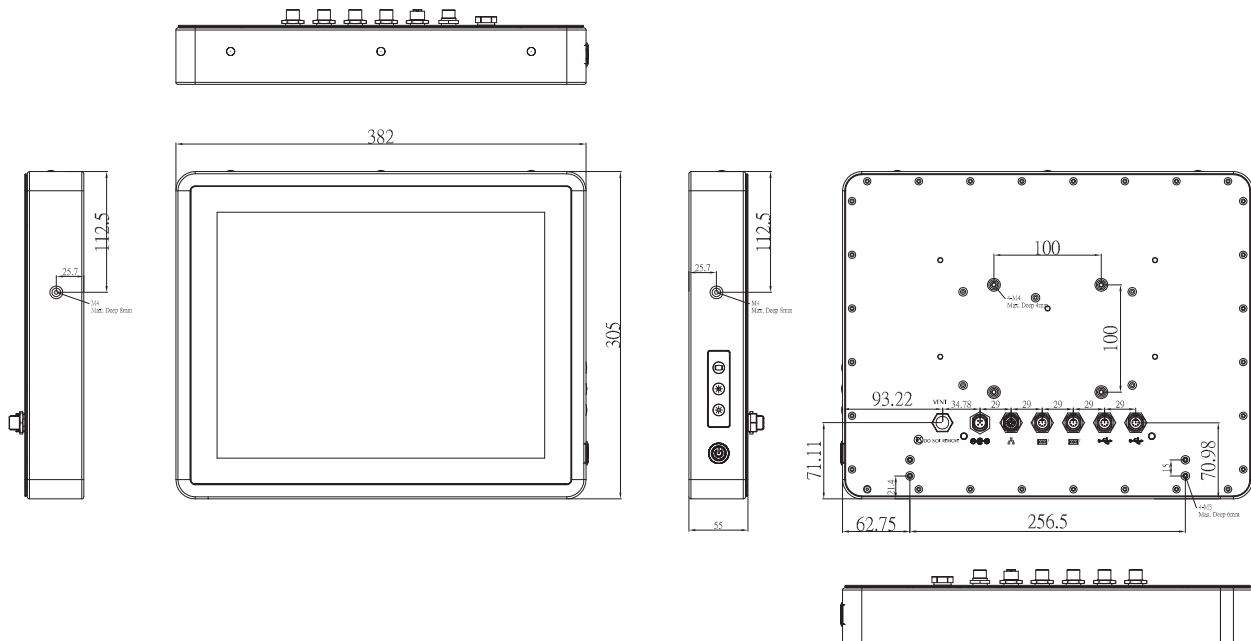

# GOT815-834

15" XGA TFT IP66 & IP69K-rated Stainless Steel Fanless PCT (or Resistive Touch) Panel Computer with Intel® Atom® Processor E3827 and Flat Bezel Design (-20°C to +55°C)

## Features

- 15" XGA TFT LCD flat bezel projected capacitive (or resistive) touch
- IP66/IP69K-rated (NEMA 4X) water/dust/corrosion-proof design
- Full stainless steel enclosure with type 316
- -20°C to +55°C wide operating temperature range
- Fanless system with Intel® Atom® processor E3827
- Optional Wi-Fi/3G kit for wireless network connectivity
- 9 to 36 VDC wide range power input
- M12 type I/O connectors for harsh environments

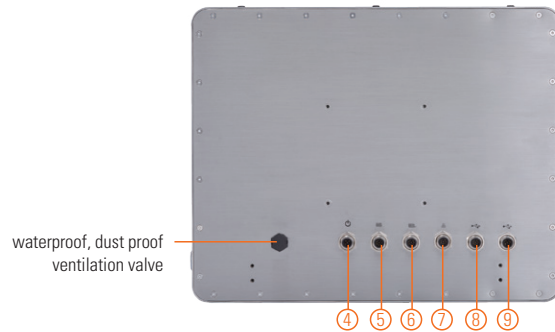

1. Backlight switch
2. Brightness adjust
3. Power switch (ATX)
4. DC power connector (A-coded)
5. 1 x RS-232/422/485 (A-coded)
6. 1 x RS-232/422/485 (A-coded)
7. 1 x LAN (X-coded)
8. 2 x USB 2.0 (A-coded)
9. 2 x USB 2.0 (A-coded)
10. 3 x Wi-Fi/3G antenna (optional, only for RF version)



## Introduction

The 15-inch GOT815-834 is specially designed for food processing applications. Its IP66-rated stainless steel housing protects entire system from damage of water, powder and dust. It also supports a wide operating temperature range from -20°C to +55°C. Thus, this robust unit is specifically designed for high humidity, dusty or wet spaces in food factories or kitchens and more harsh applications.

### Full IP66 and IP69K Compliance

The GOT815-834 adopts a water/dust-proof housing design with five IP66-rated M12 I/O connectors and IP69K compliance that ensures the product's ability to resist ingress of high temperature and high pressure water. It passed entire system IP66 test by SGS, and verified salt mist test. Additionally, it was tested by a spray nozzle with high temperature water (+80°C), a flow rate of 14 to 16 L/min and a nozzle hold with distance 10 to 15 cm away from the device at angles of 0°, 30°, 60° and 90° for 30 seconds. The GOT815-834 is qualified to meet harsh environment applications.

### Wide Temp. (-20°C to +55°C) & Anti-vibration (2G) Design Wide Temperature & Anti-vibration Design

The GOT815-834 featuring fanless and noiseless design supports a wide operating temperature range from -20°C to +55°C. Besides, the patent of anti-vibration for SSD ensures system reliability and stability.

## Specifications

Enclosure	Stainless type 316	
LCD Panel	Display Type	15" XGA TFT LCD
	Brightness (cd/m <sup>2</sup> )	420 nits
	Resolution	1024 x 768
	Viewing Angle (H/V)	160°/160°
Main System	CPU	Intel® Atom® processor E3827 1.75 GHz (Bay Trail)
	Chipset	SoC integrated
	System Memory	1 x 204-pin DDR3L-1333 SO-DIMM dual channel, up to 8GB
	BIOS	AMI with Axiomtek standard features; such as, SmartView, Ethernet Boot ROM (RPL & PXE), customer CMOS backup
	Storage	1 x 2.5" SSD 1 x CFast™
	Watchdog Timer	255 levels, 1 to 255 sec.
	Onboard Graphics	Integrated in Intel® GFX



## Specifications

I/O Connector	2 x RS-232/422/485 (default RS-232, A-Coded) 4 x USB 2.0 (A-Coded) 1 x 10/100/1000 Mbps Ethernet (X-Coded)
Expansion Interface	2 x PCI Express Mini Card slot
Touchscreen	5-wire resistive touch or projected capacitive multi-touch
Power Input	9 to 36 VDC
Power Consumption	30W
Dimensions	382 mm (15.4") (W) x 55 mm (2.17") (D) x 305 mm (12.01") (H)
Packing Dimensions	510 mm (20.07") (W) x 186 mm (7.32") (D) x 532 mm (20.94") (H)
Weight (net/gross)	5.2 kg (11.46 lb)/8.4 kg (18.51 lb)
Operating Temperature	-20°C to +55°C (-4°F to +131°F)
Relative Humidity	10% to 95% @ +40°C, non-condensing
Operation Vibration	2G, 5 - 500Hz, random for 2.5" SSD 2G, 5 - 500Hz, random for CompactFlash™
Certifications	CE

\* W.T.: Wide Temperature. All W.T. supported products have to be sorted by Axiomtek.

## Packing List

- 1 x GOT815-834
- 1 x Driver DVD
- 1 x DC cable

## Ordering Information

GOT815-834-C-DC	15" XGA fanless IP66-rated stainless steel touch panel computer with Intel® Atom® E3827, projected capacitive touch screen, flat bezel design and 9 to 36 VDC power input
GOT815-834-C-RF-DC	15" XGA fanless IP66-rated stainless steel touch panel computer with Intel® Atom® E3827, projected capacitive touch screen, flat bezel design and 9 to 36 VDC power input and Wi-Fi or 3G
GOT815-834-R-DC	15" XGA fanless IP66-rated stainless steel touch panel computer with Intel® Atom® E3827, 5-wire flat resistive touch screen, flat bezel design and 9 to 36 VDC power input
GOT815-834-R-RF-DC	15" XGA fanless IP66-rated stainless steel touch panel computer with Intel® Atom® E3827, 5-wire flat resistive touch screen, flat bezel design, 9 to 36 VDC power input and Wi-Fi or 3G

\*Specifications and certifications may vary based on different requirements.

## Optional Accessories

594B8122100E	Water-proof COM cable (1.8 m)
594B8122820E	Water-proof USB cable (1.8 m)
594B8152710E	Water-proof LAN cable (1.8 m)
50966D45010E	Adapter 24V 120W. M12 A-code 5P. LTE120ES
822B8120070E	GOT812 keyboard bracket (with keyboard)

## Optional EOS Installation

- WES 7
- WE8S

## Optional OS Installation

- Windows® 7
- Windows® 8/8.1
- Windows® 10

## Dimensions

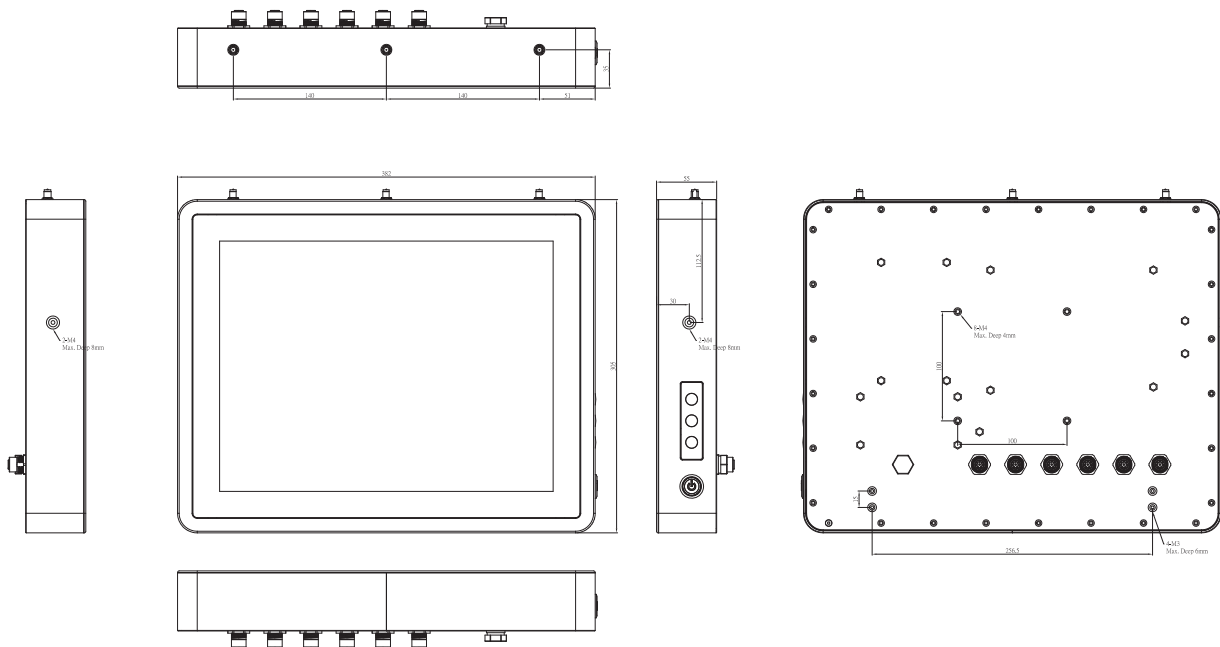

# GOT817L-511

17" SXGA TFT IP66 & IP69K-rated Stainless Steel Fanless PCT (or Resistive Touch) Panel Computer with Intel® Core™ i5-7300U Processor and Flat Bezel Design (-20°C to +50°C)

## Features

- 17" SXGA TFT flat bezel LCD display
- IP66/IP69K-rated (NEMA 4X) water/dust/corrosion-proof design
- Full stainless steel enclosure with type 316
- -20°C to +50°C wide operating temperature range
- Fanless design with Intel® Core™ i5-7300U processor
- Optional Wi-Fi/3G kit for wireless network connectivity
- 9 to 36 VDC wide range power input
- Supports suspension and VESA mount
- M12 type connectors for harsh environments

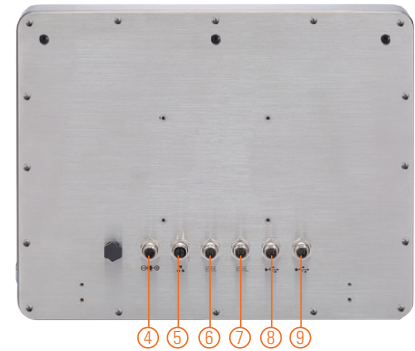
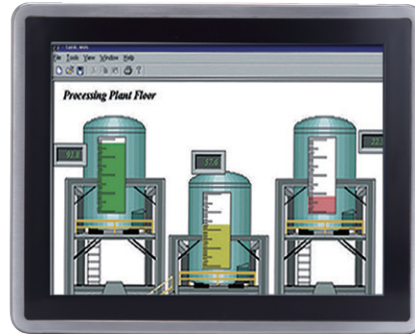

## Introduction

The 17-inch GOT817L-511 is specially designed for food processing applications. Its IP66-rated stainless steel housing protects entire system from damage of water, powder and dust. It also supports a wide operating temperature range from -20°C to +50°C. Thus, this robust unit is specifically designed for high humidity, dusty or wet spaces in food factories or kitchens and more harsh applications.

### Full IP66 and IP69K Certified

The GOT817L-511 adopts a water/dust-proof housing design with five IP66-rated M12 I/O connectors and IP69K that ensures the product's ability to resist ingress of high temperature and high pressure water. It passed entire system IP66 test by SGS, and verified salt mist test. Additionally, it was tested by a spray nozzle with high temperature water (+80°C), a flow rate of 14 to 16 L/min and a nozzle hold with distance 10 to 15 cm away from the device at angles of 0°, 30°, 60° and 90° for 30 seconds. The GOT817L-511 is qualified to meet harsh environment applications.

### Wide Temp. (-20°C to +50°C) & Anti-vibration (1G) Design

The GOT817L-511 featuring fanless and noiseless design supports a wide operating temperature range from -20°C to +50°C. Besides, the patent of anti-vibration for SSD ensures system reliability and stability.

## Specifications

Enclosure	Stainless type 316	
LCD Panel	Display Type	17" SXGA TFT LCD
	Brightness (cd/m <sup>2</sup> )	350 nits LCD
	Resolution	1280 x 1024
	Viewing Angle (H/V)	170°/160°
Main System	CPU	Intel® Core™ i5-7300U 3.5 GHz (Kaby Lake)
	Chipset	SoC integrated
	System Memory	1 x 260-pin DDR4-2133 SO-DIMM, up to 16GB
	BIOS	AMI UEFI BIOS
	Storage	1 x 2.5" SSD HDD or 1 x 2.5" SATA HDD (9.5 mm height)
	Watchdog Timer	255 levels, 1 to 255 sec.
	Onboard Graphics	Integrated in Intel® GFX

## Specifications

I/O Connector	2 x RS-232/422/485 (default RS-232, A-coded) 4 x USB 2.0 (A-coded) 1 x 10/100/1000 Mbps Ethernet supporting PXE and LAN wake-up (Intel® I210-IT; X-coded)
Expansion Interface	1 x Full-size PCI Express Mini Card slot 1 x Half-size PCI Express Mini Card slot
Touchscreen	5-wire resistive touch or projected capacitive multi-touch
Power Input	9 to 36 VDC
Power Consumption	67.5W
Dimensions	415.92 mm (16.4") (W) x 55 mm (2.2") (D) x 348.34 mm (13.7") (H)
Packing Dimensions	615 mm (24.2") (W) x 250 mm (9.84") (D) x 585 mm (23") (H)
Weight (net/gross)	6.94 kgs (15.3 lb)/10.2 kgs (22.5 lb)
Operating Temperature	-20°C to +50°C (-4°F to +122°F)
Relative Humidity	10% to 95% @ +40°C, non-condensing
Operation Vibration	1G, 5 - 500Hz, random for 2.5" SSD
Certifications	CE

\*W.T.: Wide temperature. All W.T. supported products have to be sorted by Axiomtek.

## Packing List

1 x GOT817L-511  
1 x Driver DVD  
1 x DC cable

## Ordering Information

GOT817L-511-C-DC	17" SXGA fanless IP66 & IP69K-rated stainless steel touch panel computer with Intel® Core™ i5-7300U, projected capacitive touch screen, 420 nits LCD and 9 to 36 VDC power input
GOT817L-511-R-DC	17" SXGA fanless IP66 & IP69K-rated stainless steel touch panel computer with Intel® Core™ i5-7300U, 5-wire flat resistive touch screen, 9 to 36 VDC power input

## Optional Accessories

594B8122100E	Water-proof COM cable (1.8 m)
594B8152710E	Water-proof LAN cable (1.8 m)
594B8152820E	Water-proof USB cable (1.8 m)
50966D45010E	Adapter 24V 120W, M12 A-code 5P, LTE120ES
822B8120070E	GOT812 keyboard bracket (with keyboard)

\*Specifications and certifications may vary based on different requirements.

## Optional EOS Installation

Windows® 10 IoT

## Optional OS Installation

Windows® 10

## Dimensions

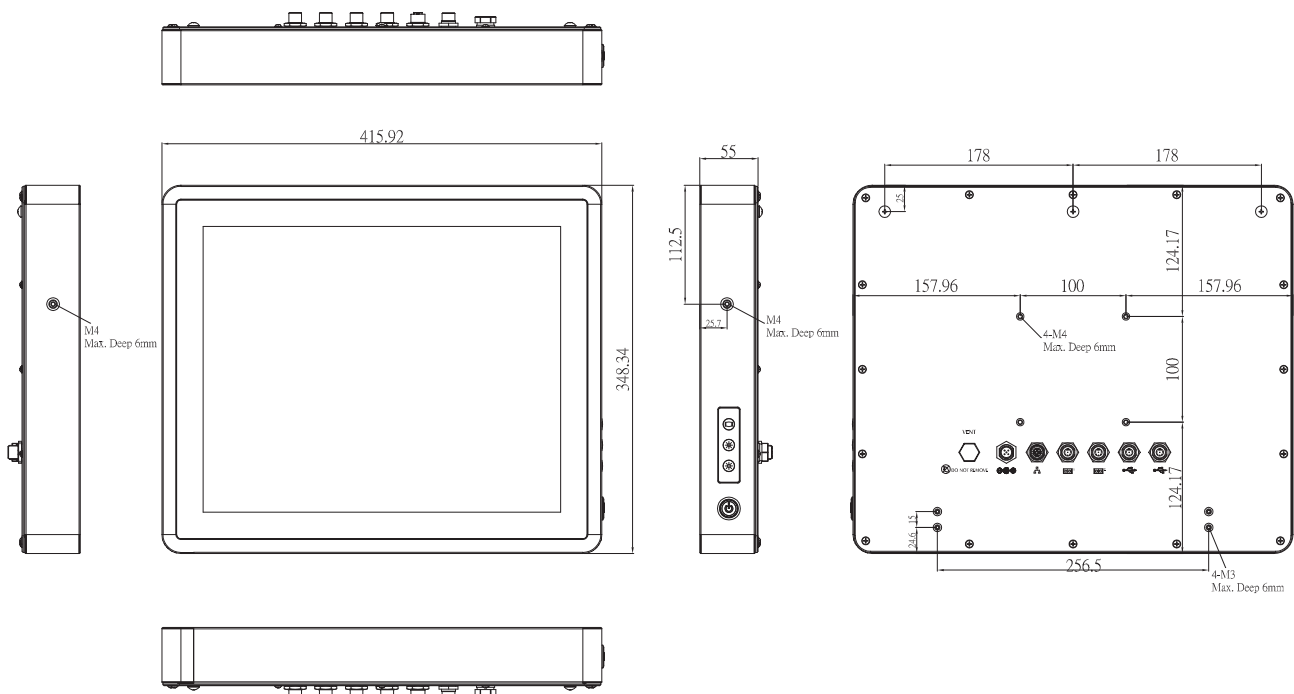

# GOT817-834

17" SXGA TFT IP66 & IP69K-rated Stainless Steel Fanless PCT (or Resistive Touch) Panel Computer with Intel® Atom® Processor E3827 and Flat Bezel Design (-20°C to +55°C)

## Features

- 17" SXGA TFT LCD flat bezel projected capacitive (or resistive) touch
- IP66/IP69K-rated (NEMA 4X) water/dust/corrosion-proof design
- Full stainless steel enclosure with type 316
- -20°C to +55°C wide operating temperature range
- Fanless system with Intel® Atom® processor E3827
- Optional Wi-Fi/3G kit for wireless network connectivity
- 12 to 36 VDC wide range power input
- M12 type I/O connectors for harsh environments

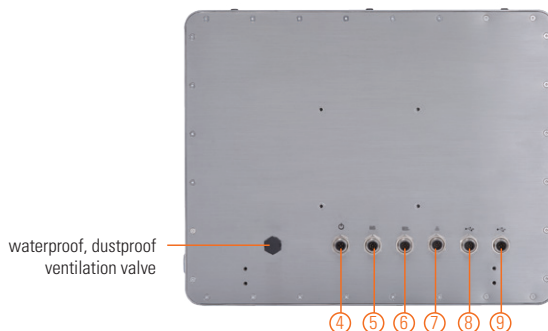
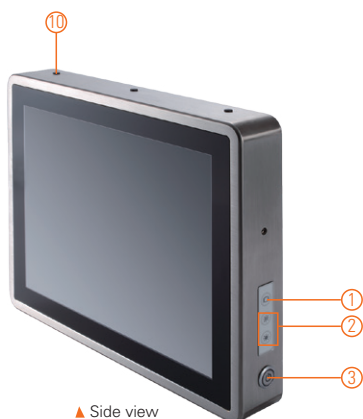

1. Backlight switch
2. Brightness adjust
3. Power switch (ATX)
4. DC power connector (A-coded M12)
5. 1 x RS-232/422/485 (A-coded M12)
6. 1 x RS-232/422/485 (A-coded M12)
7. 1 x LAN (X-coded)
8. 2 x USB 2.0 (A-coded M12)
9. 2 x USB 2.0 (A-coded M12)
10. 3 x Wi-Fi/3G antenna (optional, only for RF version)

## Introduction

The 17-inch GOT817-834 is specially designed for food processing applications. Its IP66-rated stainless steel housing protects entire system from damage of water, powder and dust. It also supports a wide operating temperature range from -20°C to +55°C. Thus, this robust unit is specifically designed for high humidity, dusty or wet spaces in food factories or kitchens and more harsh applications.

### Full IP66 and IP69K Compliance

The GOT817-834 adopts a water/dust-proof housing design with five IP66-rated M12 I/O connectors and IP69K compliance that ensures the product's ability to resist ingress of high temperature and high pressure water. It passed entire system IP66 test by SGS, and verified salt mist test. Additionally, it was tested by a spray nozzle with high temperature water (+80°C), a flow rate of 14 to 16 L/min and a nozzle hold with distance 10 to 15 cm away from the device at angles of 0°, 30°, 60° and 90° for 30 seconds. The outstanding GOT817-834 stainless touch panel PC is qualified to meet harsh environment applications.

### Wide Temp. (-20°C to +55°C) & Anti-vibration (2G) Design

The rugged 17" industrial stainless touch panel PC featuring fanless and noiseless design supports a wide operating temperature range from -20°C to +55°C. Besides, the patent of anti-vibration for SSD ensures system reliability and stability.

## Specifications

Enclosure	Stainless type 316	
LCD Panel	Display Type	17" SXGA TFT LCD
	Brightness (cd/m <sup>2</sup> )	350 nits
	Resolution	1280 x 1024
	Viewing Angle (H/V)	160°/140°
Main System	CPU	Intel® Atom® processor E3827 1.75 GHz (Bay Trail)
	Chipset	SoC integrated
	System Memory	1 x 204-pin DDR3L-1333 SO-DIMM dual channel, up to 8GB
	BIOS	AMI with Axiomtek standard features; such as, SmartView, Ethernet Boot ROM (RPL & PXE), customer CMOS backup
	Storage	1 x 2.5" SSD 1 x CFast™
	Watchdog Timer	255 levels, 1 to 255 sec.
	Onboard Graphics	Integrated in Intel® GFX

## Specifications

I/O Connector	2 x RS-232/422/485 (default RS-232, A-Coded) 4 x USB 2.0 (A-Coded) 1 x 10/100/1000 Mbps Ethernet (X-Coded)
Expansion Interface	2 x PCI Express Mini Card slot
Touchscreen	5-wire resistive touch or projected capacitive multi-touch
Power Input	12 to 36 VDC
Power Consumption	50W
Dimensions	415.92 mm (16.37") (W) x 54.96 mm (2.16") (D) x 348.34 mm (13.71") (H)
Packing Dimensions	615 mm (24.2") (W) x 250 mm (9.84") (D) x 585 mm (23") (H)
Weight (net/gross)	7.04 kg (15.52 lb)/10.3 kg (22.71 lb)
Operating Temperature	-20°C to +55°C (-4°F to +131°F)
Relative Humidity	10% to 95% @ +40°C, non-condensing
Operation Vibration	2G, 5 - 500Hz, random for 2.5" SSD 2G, 5 - 500Hz, random for CFast™
Certifications	CE

\* W.T.: Wide Temperature. All W.T. supported products have to be sorted by Axiomtek.

## Packing List

1 x GOT817-834
1 x Driver DVD
1 x DC cable

## Ordering Information

Sunlight readable type	
GOT817-834-C-DC	17" SXGA fanless IP66 & IP69K-rated stainless steel touch panel computer with Intel® Atom® E3827, projected capacitive touch screen, flat-bezel design and 12 to 36 VDC power input
GOT817-834-C-RF-DC	17" SXGA fanless IP66 & IP69K-rated stainless steel touch panel computer with Intel® Atom® E3827, projected capacitive touch screen, flat-bezel design, 12 to 36 VDC power input, and Wi-Fi or 3G
GOT817-834-R-DC	17" SXGA fanless IP66 & IP69K-rated stainless steel touch panel computer with Intel® Atom® E3827, 5-wire flat resistive touch screen, flat-bezel design and 12 to 36 VDC power input
GOT817-834-R-RF-DC	17" SXGA fanless IP66 & IP69K-rated stainless steel touch panel computer with Intel® Atom® E3827, 5-wire flat resistive touch screen, flat-bezel design, 12 to 36 VDC power input and Wi-Fi or 3G

\*Specifications and certifications may vary based on different requirements.

## Optional Accessories

594B8122100E	Water-proof COM cable (1.8 m)
594B8122820E	Water-proof USB cable (1.8 m)
594B8152710E	Water-proof LAN cable (1.8 m)
50966D45010E	Adapter 24V 120W. M12 A-code 5P. LTE120ES
822B8120070E	GOT812 keyboard bracket (with keyboard)

## Optional EOS Installation

WES 7
WE8S
Windows® 10 IoT

## Optional OS Installation

Windows® 7
Windows® 8/8.1
Windows® 10

## Dimensions

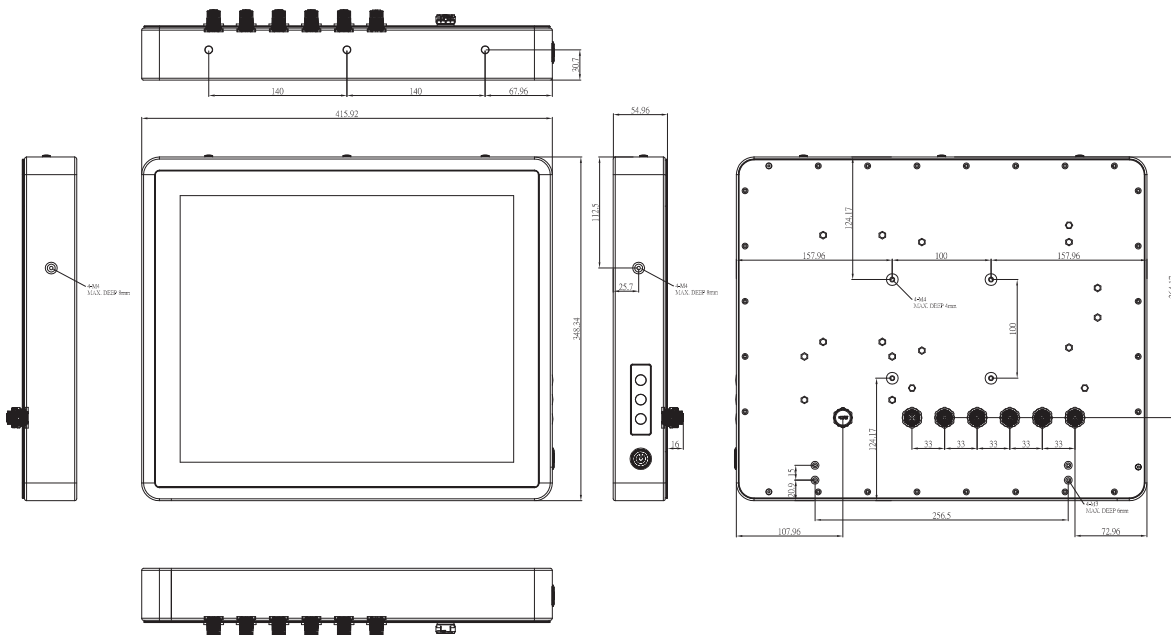



Fanless Touch Panel Computers

Heavy-duty Fanless Touch Panel Computers

Vehicle Mount Terminal Computer

Stainless Touch Panel Computers

Transportation Touch Panel Computers and Displays

Industrial Touch Panel Computers

Industrial Touch Monitors

Medical Panel Computers

Open Frame Panel Computer

# Industrial Panel PCs



# 5

## Transportation Touch Panel Computers & Displays

The GOT700 series is designed as a train operator interface to inform the train engineer about the status of the train's functions during operation. Its rugged design offers an extended operating temperature range of -25°C to +70°C. The GOT700 product line complies with the EMC, shock and vibration test requirements of the European standard EN 50155 for railway applications. The P6100 series is EN50155 certified touchscreen railway display designed specifically for transportation application. The railway touchscreen display has an industrial-grade IP65/NEMA 4/12 compliant metal front bezel which resists water spillage and is specifically designed for railway sector. It could work perfectly for displaying information of train functions, fleet management, and many types of heavy transport equipment.

Selection Guide		295
GOT710-837	10.4" SVGA TFT EN 50155 Railway Fanless Touch Panel PC with Intel® Atom® Processor E3845 1.91 GHz [-25°C to +70°C]	297
GOT712-837	12.1" XGA TFT EN 50155 Railway Fanless Touch Panel PC with Intel® Atom® Processor E3845 1.91 GHz [-25°C to +70°C]	299
P6105	10.4" XGA TFT EN 50155 Railway Touch Display [-25°C to +55°C]	301
 P6125	12.1" XGA TFT EN 50155 Railway Touch Display [-25°C to +55°C]	303

# Transportation Touch Panel Computers

## Selection Guide



Features/Models	GOT710-837	GOT712-837
<b>CPU Level</b>	Intel® Atom® E3845 (1.91 GHz)	Intel® Atom® E3845 (1.91 GHz)
<b>Chipset</b>	SoC intergrated	SoC intergrated
<b>System Memory</b>	DDR3 4GB memory onboard	DDR3 4GB memory onboard
<b>Display</b>	10.4" SVGA TFT, 1000 nits	12.1" XGA TFT, 800 nits
<b>I/O</b>	2 x RS-232/422/485 with isolated 1.5KV (M12, A-coded) 2 x RJ-45 with isolated 1.5KV (M12, X-coded) 2 x USB 2.0 (M12, A-coded) 1 x DC power input with isolated 1.5KV (M12, A-coded) 1 x Audio (Line-out & Mic-in), Speaker (D-sub) 1 x DIO (6-in/2-out) with isolated 1.5KV (D-sub) 1 x CANbus with isolated 1.5KV (D-sub)	2 x RS-232/422/485 with isolated 1.5KV (M12, A-coded) 2 x RJ-45 with isolated 1.5KV (M12, X-coded) 2 x USB 2.0 (M12, A-coded) 1 x DC power input with isolated 1.5KV (M12, A-coded) 1 x Audio (Line-out & Mic-in), Speaker (D-sub) 1 x DIO (6-in/2-out) with isolated 1.5KV (D-sub) 1 x CANbus with isolated 1.5KV (D-sub)
<b>Storage</b>	16GB flash onboard 1 x mSATA	16GB flash onboard 1 x mSATA
<b>Expansion Interface</b>	2 x PCI Express Mini Card slot	2 x PCI Express Mini Card slot
<b>Touchscreen</b>	5-wire resistive type or glass with keyboard	5-wire resistive type or glass with keyboard
<b>Operating System</b>	Windows® 8.1, WE8S, Windows® 7, WES7 Windows® 10 (IoT)	Windows® 8.1, WE8S, Windows® 7, WES7 Windows® 10 (IoT)
<b>Power Supply</b>	16.8 to 30 VDC or 77 to 137.5 VDC	16.8 to 30 VDC or 77 to 137.5 VDC
<b>Power Consumption</b>	36W	35W
<b>Watchdog Timer</b>	255 levels, 1 to 255 sec.	255 levels, 1 to 255 sec.
<b>Front Bezel</b>	Aluminum with rugged protection	Aluminum with rugged protection
<b>Dimensions (W x D x H)</b>	310 x 65 x 216 mm (12.20" x 2.56" x 8.50")	330 x 64.4 x 245 mm (13" x 2.53" x 9.65")
<b>Weight (net/gross)</b>	2.4 kg (5.29 lb)/5 kg (11.02 lb)	2.4 kg (5.29lb)/5 kg (11.02lb)
<b>Operating Temperature</b>	-25°C to +70°C (-13°F to +158°F)	-25°C to +70°C (-13°F to +158°F)
<b>Certifications</b>	EN 50155 railway EN 50121-3-2 railway EMC EN 61373 railway shock/vibration	EN 50155 railway EN 50121-3-2 railway EMC EN 61373 railway shock/vibration

# Transportation Touch Displays

## Selection Guide



NEW



Features/Models	P6105	P6125
<b>Display Type</b>	10.4" XGA TFT NEMA 4/12 & IP65	12.1" XGA TFT NEMA 4/12 & IP65
<b>Max. Colors</b>	16.2M	16.2M
<b>Active Area (mm)</b>	210.4 x 157.8	210.4 x 157.8
<b>Max. Resolution</b>	1024 x 768	1024 x 768
<b>Display Mode</b>	VGA 640 x 480 (60/72 Hz) SVGA 800 x 600 (60/72 Hz) XGA 1024 x 768 (60/72 Hz)	VGA 640 x 480 (60/72 Hz) SVGA 800 x 600 (60/72 Hz) XGA 1024 x 768 (60/72 Hz)
<b>Pixel Pitch (H x V, mm)</b>	0.0685 x 0.2055	0.0685 x 0.2055
<b>Backlight</b>	LED	LED
<b>Backlight MTBF (hrs)</b>	50,000	50,000
<b>Viewing Angle (H/V)</b>	176°/176°	176°/176°
<b>Response Time</b>	25ms	25ms
<b>Contrast Ratio</b>	1000 (TYP)	1000 (TYP)
<b>Brightness (cd/m<sup>2</sup>)</b>	500 nits	800 nits
<b>Display Control</b>	OSD	OSD
<b>I/O Connectors</b>	1 x DC power input 1 x RS-232 for touch and remote control 1 x VGA 1 x HDMI 1 x DVI-D 1 x Line-in	1 x DC power input 1 x RS-232 for touch and remote control 1 x VGA 1 x HDMI 1 x DVI-D 1 x Line-in
<b>Touchscreen</b>	Resistive type	Resistive type
<b>Power Consumption</b>	16W	33W
<b>Power Supply</b>	24 or 110 VDC power input	24 or 110 VDC power input
<b>Dimensions (W x D x H)</b>	310 x 49 x 214 mm (12.20" x 1.94" x 8.43")	330 x 57 x 245 mm (12.99" x 2.24" x 9.65")
<b>Weight (net/gross)</b>	2.0 kg (4.4 lb)/3.25 kg (7.16 lb)	2.2 kg (4.85 lb)/3.45 kg (7.61 lb)
<b>Operating Temperature</b>	-25°C to +55°C (-13°F to +131°F)	-25°C to +55°C (-13°F to +131°F)
<b>Mounting</b>	Panel mount/Wall mount/VESA arm	Panel mount/Wall mount/VESA arm
<b>Certifications</b>	EN 50155 railway EN 50121-3-2 railway EMC EN 613703 railway shock/vibration	EN 50155 railway EN 50121-3-2 railway EMC EN 613703 railway shock/vibration

Transportation  
Touch Panels &  
Computers &  
Displays

- 1
- 2
- 3
- 4
- 5
- 6
- 7
- 8
- 9

# GOT710-837

10.4" SVGA TFT EN 50155 Railway Fanless Touch Panel PC with Intel® Atom® Processor E3845 1.91 GHz (-25°C to +70°C )

## Features

- Sunlight readable 10.4" SVGA LCD with 1000 nits of brightness
- Intel® Atom® processor E3845 1.91 GHz
- Alternative keypad control in the front bezel
- M12-type lockable connectors design
- Auto-dimming for different environments
- -25°C to +70°C wide temperature range (T3 Level)
- EN 50155 certified for railway application



▲ Side view

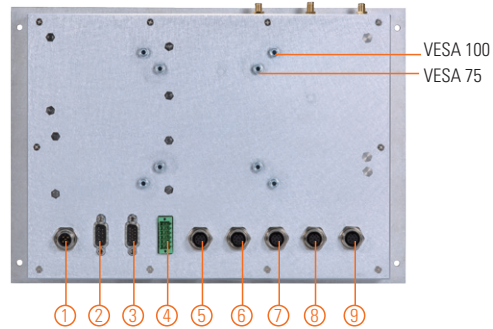
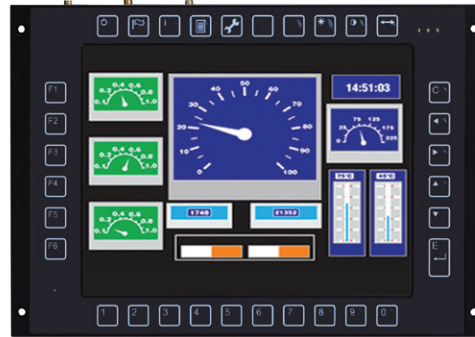

VESA 100  
VESA 75



1. DC power input with isolation 1.5KV
2. CANbus with isolation 1.5KV
3. Audio (Line-out, Line-in, Speaker-out)
4. DIO (6-in/2-out with isolation 1.5KV)
5. 2 x USB 2.0
6. 1 x RS-232/422/485 with isolation 1.5KV
7. 1 x RS-232/422/485 with isolation 1.5KV
8. 1 x LAN with isolation 1.5KV
9. 1 x LAN with isolation 1.5KV

## Introduction

The EN 50155 certified, GOT710-837 is equipped with a 10.4-inch SVGA TFT LCD display with high brightness LED backlight (1000 nits), which allows a train operator to easily read any operational status messages, even under direct sunlight. Design for ease of use and maintenance, this all-in-one 10.4" railway touch panel PC also has an alternative keypad control on the front panel for easy access and cleaning purposes. This feature-rich panel PC has an IP65-rated, M12 connectors and is EN 50155 certified.

### Wide Temperature Range (-25°C to +70°C)

The Intel® Atom®-based railway panel PC, GOT710-837, applies unique extended temperature technology with wide temperature range support as well as fanless operation. It also has a high brightness display and compact design for transport heavy-duty environment.

### Designed for Railway Application

The Axiomtek GOT710-837 is particularly suitable for demanding HMI applications in the railway sector, including tasks like monitoring and controlling as speed, temperature, and security, or for fleet management. To ensure the reliable operation in a variety of different locations, the 10.4-inch railway panel PC supports various mounting options: panel mount, wall mount, VESA arm and desktop stand. Moreover, it is also ready for Windows® 8.1 or 7.

## Specifications

Front Bezel	IP65, NEMA 4 rugged protection, aluminum front bezel	
LCD Panel	Display Type	10.4" SVGA TFT LCD
	Brightness (cd/m <sup>2</sup> )	1000 nits
	Resolution	800 x 600
	Viewing Angle (H/V)	160°/160°
Main System	CPU	Intel® Atom® processor E3845 1.91 GHz (Bay Trail)
	Chipset	SoC integrated
	System Memory	DDR3 4GB (default) or 8GB memory onboard
	BIOS	AMI with Axiomtek standard features; such as SmartView, Ethernet Boot ROM (RPL & PXE), customer CMOS backup
	Storage	16GB flash onboard 1 x mSATA
	Watchdog Timer	255 levels, 1 to 255 sec.
	Onboard Graphics	Integrated in Intel® GFX

## Specifications

I/O Connector	2 x RS-232/422/485 with isolation 1.5KV (M12, A-coded) 2 x RJ-45 with isolation 1.5KV (M12, X-coded) 2 x USB 2.0 (M12, A-coded) 1 x DC power input with isolation 1.5KV (M12, A-coded) 1 x Audio (Line-out & Mic-in), Speaker (D-sub) 1 x DIO (6-in/2-out) with isolation 1.5KV (phoenix type) 1 x CANbus with isolation 1.5KV (D-sub)
Expansion Interface	2 x PCI Express Mini Card slot
Flat Panel	Alternative 5-wire resistive touch panel or keyboard
Power Supply	16.8V to 30 VDC or 77V to 137.5 VDC 10ms hold up time (S2)
Power Consumption	36W
Dimensions	310 mm (12.20") (W) x 65.05 mm (2.56") (D) x 216 mm (8.50") (H)
Packing Dimensions	382 mm (15.04") (W) x 185 mm (7.28") (D) x 427 mm (16.81") (H)
Weight (net/gross)	2.4 kg (5.29 lb)/5 kg (11.02 lb)
Operating Temperature	-25°C to +70°C (-13°F to +158°F)
Relative Humidity	10% to 95% @ +40°C, non-condensing
Certifications	EN 50155, EN 50121-3-2 EMC, EN 61373 (shock/vibration), EN 45545 (fire) certified Compliance with UIC 612-01 (keypad)

\* W.T.: Wide Temperature. All W.T. supported products have to be sorted by Axiomtek.

## Packing List

- 1 x GOT710-837 unit
- 1 x Driver CD
- 1 x Power cable
- 1 x Phoenix connector



▲ Touch without keypad version

## Dimensions

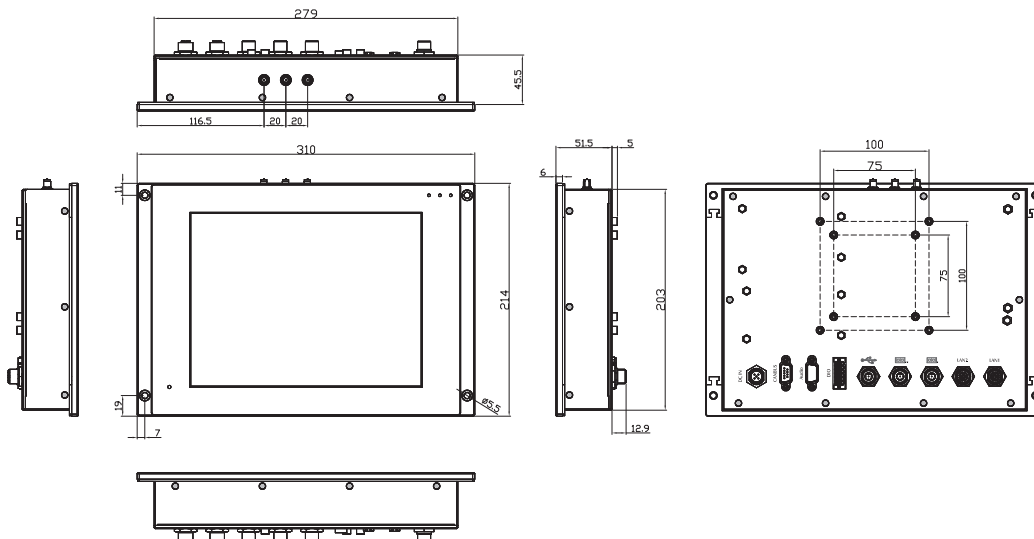

## Ordering Information

### 24 VDC Power Input (14.4V to 40 VDC)

GOT710-837-R-E3845-24 VDC	10.4" SVGA EN 50155 railway fanless touch panel computer with Intel® Atom® E3845, sunlight readable LCD (1000 nits), 5-wire resistive touch screen and 24 VDC power input
GOT710-837-R-E3845-24 VDC with keypad	10.4" SVGA EN 50155 railway fanless touch panel computer with Intel® Atom® E3845, sunlight readable LCD (1000 nits), 5-wire resistive touch screen, 24 VDC power input and keypad
GOT710-837-G-E3845-24 VDC with keypad	10.4" SVGA EN 50155 railway fanless touch panel computer with Intel® Atom® E3845, sunlight readable LCD (1000 nits), non-touch screen, 24 VDC power input and keypad

### 110 VDC Power Input (66V to 154 VDC)

GOT710-837-R-E3845-110 VDC	10.4" SVGA EN 50155 railway fanless touch panel computer with Intel® Atom® E3845, sunlight readable LCD (1000 nits), 5-wire resistive touch screen and 110 VDC power input
GOT710-837-R-E3845-110 VDC with keypad	10.4" SVGA EN 50155 railway fanless touch panel computer with Intel® Atom® E3845, sunlight readable LCD (1000 nits), 5-wire resistive touch screen, 110 VDC power input and keypad
GOT710-837-G-E3845-110 VDC with keypad	10.4" SVGA EN 50155 railway fanless touch panel computer with Intel® Atom® E3845, sunlight readable LCD (1000 nits), non-touch screen, 110 VDC power input and keypad

\*Specifications and certifications may vary based on different requirements.

## Optional Accessories

822B7100140E	GOT710 3G+GPS kit
8812B7100A0E	GOT710 Wi-Fi Kit
594B8122820E	M12 A-coded USB cable
594B7102100E	RS-232 cable
594B7102700E	M12 X-coded LAN cable

## Optional EOS Installation

WES 7  
 WE8S  
 Windows® 10 (IoT)

## Optional OS Installation

Windows® 7  
 Windows® 8/8.1  
 Windows® 10

# GOT712-837

12.1" XGA TFT EN 50155 Railway Fanless Touch Panel PC with Intel® Atom® Processor E3845 1.91 GHz (-25°C to +70°C )

## Features

- Sunlight readable 12.1" XGA LCD with a high brightness of 800 nits
- Fanless with Intel® Atom® processor E3845 1.91 GHz
- All lockable connectors design
- Auto-dimming for different environments
- -25°C to +70°C wide temperature range
- EN 50155 compliance for railway application



▲ Side view

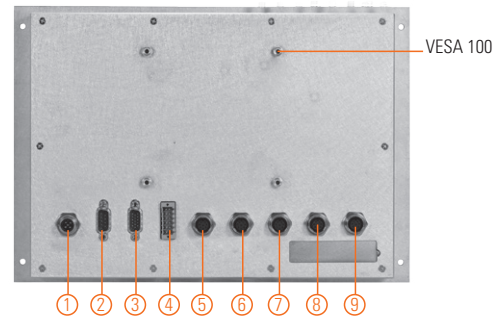

1. DC power input with isolation 1.5KV
2. CANbus with isolation 1.5KV
3. Audio (Line-out & Mic-in), Speaker
4. DIO (6-in/2-out with isolation 1.5KV)
5. 2 x USB 2.0
6. 1 x RS-232/422/485 with isolation 1.5KV
7. 1 x RS-232/422/485 with isolation 1.5KV
8. 1 x LAN with isolation 1.5KV
9. 1 x LAN with isolation 1.5KV



## Introduction

The EN 50155 railway touch panel PC, GOT712-837, is equipped with a 12.1-inch XGA TFT LCD display with high brightness LED backlight (800 nits), which allows a train operator to easily read any operational status messages, even under direct sunlight. Design for ease of use and maintenance, this all-in-one 12.1" railway touch panel PC also has an alternative keypad control on the front panel for easy access and cleaning purposes. This feature-rich panel PC has an IP65-rated front bezel, M12 connectors and is EN 50155 compliance.

### Wide Temperature Range (-25°C to +70°C)

The Intel® Atom®-based railway panel PC, GOT712-837, applies unique extended temperature technology with wide temperature range support as well as fanless operation. It also has a high brightness display and compact design for transport heavy-duty environment.

### Designed for Railway Application

The Axiomtek GOT712-837 is particularly suitable for demanding HMI applications in the railway sector, including tasks like monitoring and controlling speed, temperature, and security, or for fleet management. To ensure the panel reliable operation in a variety of different locations, the 12.1-inch railway panel PC supports various mounting options: panel mount, wall mount, VESA arm and desktop stand. Moreover, it is also ready for Windows® 8.1 or 7.

## Specifications

Front Bezel	IP65, NEMA 4 rugged protection, aluminum front bezel	
LCD Panel	Display Type	12.1" XGA TFT LCD
	Brightness (cd/m <sup>2</sup> )	800 nits
	Resolution	1024 x 768
	Viewing Angle (H/V)	160°/160°
Main System	CPU	Intel® Atom® processor E3845 1.91 GHz (Bay Trail)
	Chipset	SoC integrated
	System Memory	DDR3 4GB (default) or 8GB memory onboard
	BIOS	AMI with Axiomtek standard features; such as SmartView, Ethernet Boot ROM (RPL & PXE), customer CMOS backup
	Storage	16GB flash onboard 1 x mSATA
	Watchdog Timer	255 levels, 1 to 255 sec.
	Onboard Graphics	Integrated in Intel® GFX



## Specifications

I/O Connector	2 x RS-232/422/485 with isolation 1.5KV (M12, A-coded) 2 x 10/100/1000 Mbps Ethernet with isolation 1.5KV (M12, X-coded) 2 x USB 2.0 (M12, A-coded) 1 x DC power input with isolation 1.5KV (M12, A-coded) 1 x Audio (Line-out & Mic-in), Speaker (D-sub) 1 x DIO (6-in/2-out) with isolation 1.5KV (phoenix type) 1 x CANbus with isolation 1.5KV (D-sub)
Expansion Interface	2 x PCI Express Mini Card slot
Flat Panel	Alternative 5-wire resistive touch panel or keyboard
Power Supply	16.8V to 30 VDC or 77V to 137.5 VDC 10ms hold up time (S2)
Power Consumption	35W
Dimensions	330 mm (13") (W) x 64.4 mm (2.53") (D) x 245 mm (9.65") (H)
Packing Dimensions	510 mm (20.08") (W) x 186 mm (7.32") (D) x 532 mm (20.94") (H)
Weight (net/gross)	5.54 kg (12.21 lb)/3 kg (6.61 lb)
Operating Temperature	-25°C to +70°C (-13°F to +158°F)
Relative Humidity	10% to 95% @ +40°C, non-condensing
Certifications	EN 50155, EN 50121-3-2 EMC, EN 61373 (shock/vibration), EN 45545 (fire) compliance

\* W.T.: Wide Temperature. All W.T. supported products have to be sorted by Axiomtek.

## Packing List

- 1 x GOT712-837 unit
- 1 x Driver CD
- 1 x Power cable
- 1 x Phoenix connector

## Dimensions

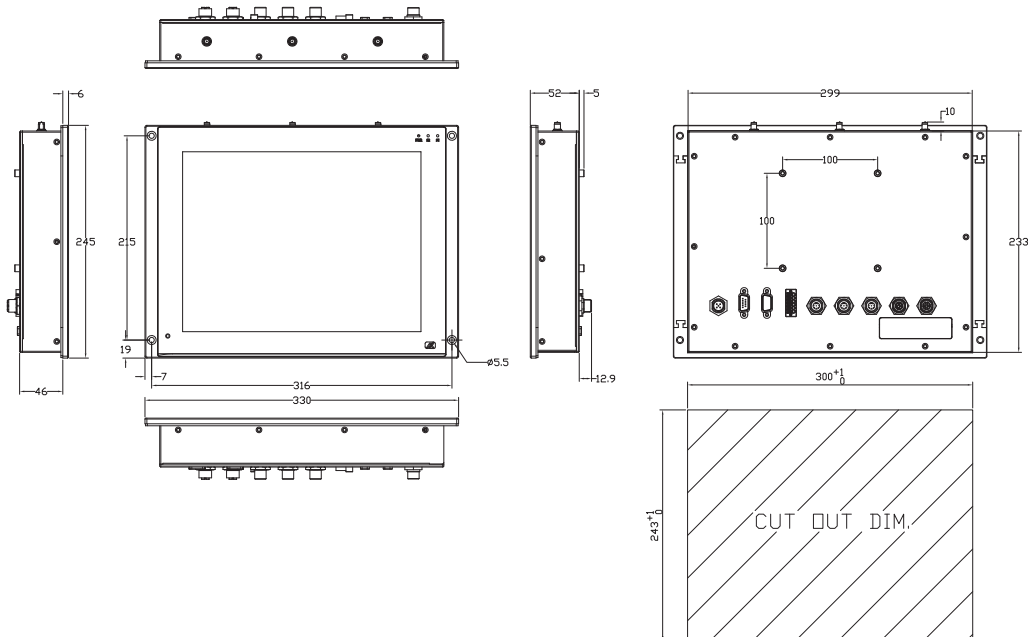

\* All specifications and photos are subject to change without notice. [www.axiomtek.com](http://www.axiomtek.com) © 2019 Axiomtek Co., Ltd. All rights reserved.

## Ordering Information

### 24VDC Power Input (14.4V to 40VDC)

GOT712-837-R-E3845-24VDC	12" XGA EN 50155 railway fanless touch panel computer with Intel® Atom® E3845, sunlight readable CD (800 nits), 5-wire resistive touch screen and 24 VDC power input
--------------------------	--

### 110VDC Power Input (66V to 154VDC)

GOT712-837-R-E3845-110VDC	12" XGA EN 50155 railway fanless touch panel computer with Intel® Atom® E3845, sunlight readable LCD (800 nits), 5-wire resistive touch screen and 110 VDC power input
---------------------------	--

\*Specifications and certifications may vary based on different requirements.

## Optional Accessories

822B7100140E	GOT712 3G+GPS kit
8812B7100A0E	GOT712 Wi-Fi kit
594B8122820E	M12 A-coded USB cable
594B7102100E	RS-232 cable
594B7102700E	M12 X-coded LAN cable

## Optional EOS Installation

WES 7

WE8S

Windows® 10 (IoT)

## Optional OS Installation

Windows® 7

Windows® 8/8.1

Windows® 10



▲ Touch without keypad version

# P6105

10.4" XGA TFT EN 50155 Railway Touch Display (-25°C to +55°C)

## Features

- EN 50155 certified monitor for railway application
- 10.4" high brightness XGA TFT touchscreen LCD
- Wide viewing angle and high brightness 500 nits
- VGA, DVI-D and HDMI with multiple video inputs
- Light sensor for auto-dimming (optional)
- 24 VDC or 110 VDC power input
- -25°C to +55°C wide temperature range
- Supports 5 OSD keys on the front panel



1. Menu
2. SEL+
3. SEL-
4. Exit
5. Power LED
6. Power switch



▲ Side view

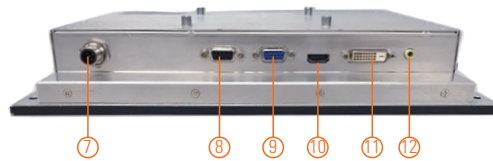

7. DC power input
8. 1 x RS-232 (touch & remote control)
9. 1 x VGA
10. 1 x HDMI
11. DVI-D
12. Line-in
13. Speaker



## Introduction

The EN 50155 railway touch display P6105 adopts a 10.4-inch XGA TFT LCD with 500 nits brightness and a 5-wire resistive touch screen with IP65-rated aluminum front bezel to provide protection of liquid damage and user friendly control interface.

### Wide Temperature (-25°C to +55°C)

The Axiomtek 10.4-inch railway touch monitor adopts extended temperature technology with a wide range from -25°C to +55°C and fanless cooling system as well as super compact design for transportation & harsh environment.

### High brightness 500 nits with wide viewing angle

The railway grade EN 50155 touchscreen display P6105 adopts a high brightness 500 nits 10.4-inch LCD with sunlight readable technology. The screen is legible even under strong sunlight and is readable under skies outdoor in parking lots and more. With its wide viewing angle, user won't miss information on the display.

### Anti-vibration for railway

With an anti-vibration design and EN 50155 class T1 certification, the Axiomtek rugged 10.4" railway touch display can work perfectly on the train.

## Specifications

Front Bezel	NEMA 4/12 (IP65)-compliant, metal front bezel	
LCD Panel	Display Type	10.4" TFT XGA LCD
	Max. Resolution	1024 x 768
	Max. Colors	16.2M/262k
	Active Area (mm)	210.4 (H) x 157.8 (V)
	Pixel Pitch (mm)	0.0685 (H) x 0.2055 (V)
	Response Time	25ms
	Backlight	LED
	Backlight MTBF	50,000 hrs
	Viewing Angle (H/V)	176°/176°
	Contrast Ratio	1000 (TYP.)
Brightness (cd/m <sup>2</sup> )	500 nits	
Display Control	OSD (on screen display)	
Display Mode	VGA 640 x 480 (60/72 Hz)	
	SVGA 800 x 600 (60/72 Hz)	
	XGA 1024 x 768 (60/72 Hz)	
Input Signal	VGA	
	HDMI	
	DVI-D	
	RS-232 for touchscreen and IR remote control	

## Specifications

I/O Connectors	1 x RS-232 for touchscreen and remote control 1 x HDMI 1 x DVI-D 1 x DC power input 1 x VGA 1 x Line-in
Power Supply	24 VDC or 110 VDC power input
Power Consumption	24V, 16W
Touchscreen	Thickness Resistive: 2.2 mm Light Transmission Resistive: 80% Power Consumption Resistive: +5V @ 100mA Touch Life Resistive: 35 million touches Controller Interface: RS-232 D-type 9-pin male connector
Dimensions	310 mm (12.20") (W) x 49 mm (1.94") (D) x 214 mm (8.43") (H)
Packing Dimensions	372 mm (14.65") (W) x 175 mm (6.89") (W) x 412 mm (16.2") (H)
Weight (net/gross)	2.2 kg (4.85 lb) /3.45 kg (7.61 lb)
Operating Temperature	-25°C to +55°C (-13°F to +131°F)
Relative Humidity	20% to 90% @ +40°C, non-condensing
Certifications	CE, EN 50155

## Packing List

- 1 x P6105 unit
- 1 x VGA cable
- 1 x RS-232 cable (for resistive touch)

## Ordering Information

P6105PR-24VDC with VGA	10.4" XGA railway touch display with EN 50155 and 24 VDC power input
P6105PR-110VDC with VGA	10.4" XGA railway touch display with EN 50155 and 110 VDC power input

\*Specifications and certifications may vary based on different requirements.

## Optional Accessories

5946L203800E	HDMI cable
59461713400E	DVI cable



▲ Raer view

## Dimensions

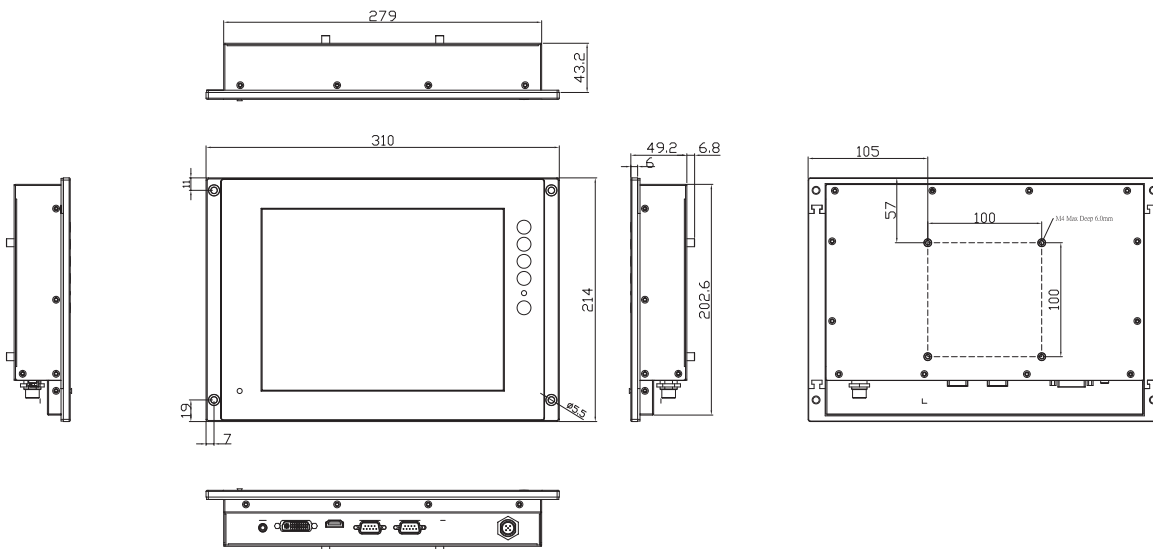

# P6125 NEW

12.1" XGA TFT EN 50155 Railway Touch Display (-25°C to +55°C)

## Features

- EN 50155 compliant monitor for railway application
- 12.1" high brightness XGA TFT touchscreen LCD
- Wide viewing angle and high brightness 800 nits
- VGA, DVI-D and HDMI with multiple video inputs
- Light sensor for auto-dimming (optional)
- 24 VDC to 110 VDC power input
- -25°C to +55°C wide temperature range
- Supports 5 OSD keys on the front panel

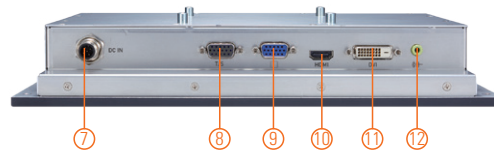

7. DC power input
8. 1 x RS-232 (touch & remote control)
9. 1 x VGA
10. 1 x HDMI
11. DVI-D
12. Line-in
13. Speaker



## Introduction

The EN 50155 compliant railway touch display P6125 adopts a 12.1-inch XGA TFT LCD with 800 nits of brightness and a 5-wire resistive touch screen with IP65-rated aluminum front bezel to provide protection of liquid damage and user friendly control interface.

### Wide Temperature (-25°C to +55°C)

The 10.4-inch EN50155 compliant railway touch monitor supports a wide temperature range from -25°C to +55°C. Its fanless cooling system and super compact designs are suited for rolling stock applications as well as other harsh environments.

### High brightness 500 nits with wide viewing angle

The railway grade P6125 adopts a high brightness of 800 nits 12.1-inch LCD with sunlight readable technology. The screen is legible even under strong sunlight and is readable under skies outdoor in parking lots and more. Additionally, with its wide viewing angle feature, users won't miss any information.

### Anti-vibration for railway

With an anti-vibration design and EN 50155 class T1 compliance, the Axiomtek rugged 12.1" railway touch display can work perfectly on the train.

## Specifications

Front Bezel	NEMA 4/12 (IP65)-compliant, metal front bezel	
LCD Panel	Display Type	12.1" TFT XGA LCD
	Max. Resolution	1024 x 768
	Max. Colors	16.2M/262k
	Active Area (mm)	210.4 (H) x 157.8 (V)
	Pixel Pitch (mm)	0.0685 (H) x 0.2055 (V)
	Response Time	25ms
	Backlight	LED
	Backlight MTBF	50,000 hrs
	Viewing Angle (H/V)	176°/176°
	Contrast Ratio	1000 (TYP.)
Brightness (cd/m <sup>2</sup> )	800 nits	
Display Control	OSD (on screen display)	
Display Mode	VGA 640 x 480 (60/72 Hz)	
	SVGA 800 x 600 (60/72 Hz)	
	XGA 1024 x 768 (60/72 Hz)	
Input Signal	VGA	
	HDMI	
	DVI-D	
	RS-232 for touchscreen and IR remote control	

## Specifications

I/O Connectors	1 x RS-232 for touchscreen and remote control 1 x HDMI 1 x DVI-D 1 x DC power input 1 x VGA 1 x Line-in
Power Supply	24 VDC to 110 VDC power input
Power Consumption	33W
Touchscreen	Thickness Resistive: 2.2 mm Light Transmission Resistive: 80% Power Consumption Resistive: +5V @ 100mA Touch Life Resistive: 35 million touches Controller Interface: RS-232 D-type 9-pin male connector
Dimensions	330 mm (12.99") (W) x 57 mm (2.24") (D) x 245 mm (9.65") (H)
Packing Dimensions	510 mm (20.08") (W) x 186 mm (7.32") (W) x 532 mm (20.94") (H)
Weight (net/gross)	2.2 kg (4.85 lb)/3.45 kg (7.61 lb)
Operating Temperature	-25°C to +55°C (-13°F to +131°F)
Relative Humidity	20% to 90% @ +40°C, non-condensing
Certifications	CE, EN 50155 compliance

## Packing List

- 1 x P6125 unit
- 1 x VGA cable
- 1 x RS-232 cable (for resistive touch)

## Ordering Information

P6125PR	12.1" XGA railway touch display with 24 VDC to 110 VDC power input
---------	--

\*Specifications and certifications may vary based on different requirements.

## Optional Accessories

5946L203800E	HDMI cable
59461713400E	DVI cable



▲ Rear view

## Dimensions

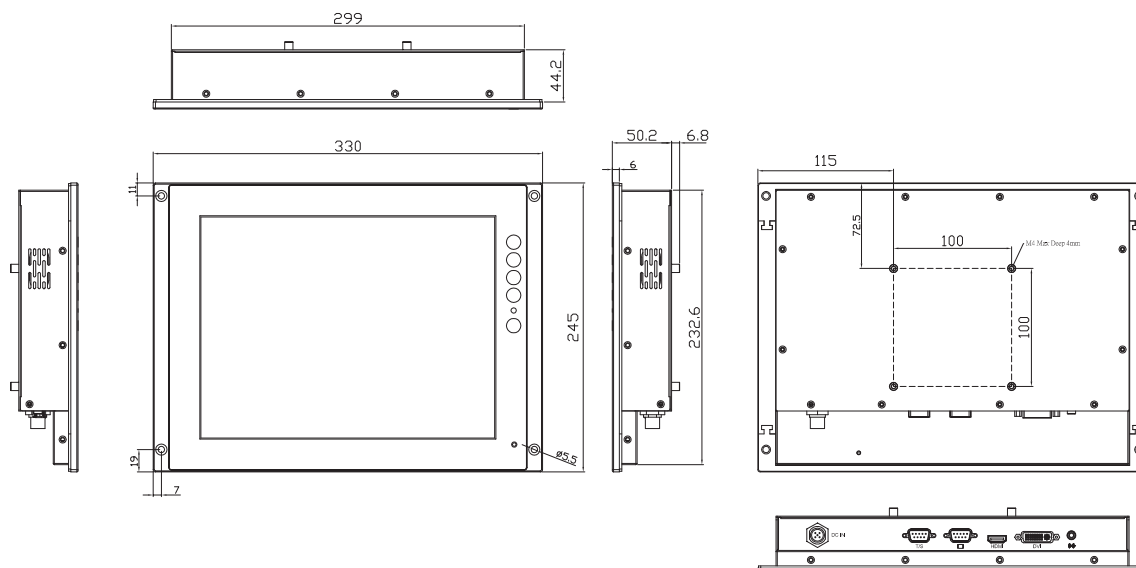



Fanless Touch Panel Computers

Heavy-duty Fanless Touch Panel Computers

Vehicle Mount Terminal Computer

Stainless Touch Panel Computers

Transportation Touch Panel Computers and Displays

Industrial Touch Panel Computers

Industrial Touch Monitors

Medical Panel Computers

Open Frame Panel Computer

# Industrial Panel PCs



# 6

## Industrial Touch Panel Computers

Axiomtek provides a complete range of industrial panel computers for automation applications. The high performance P1000 series focuses on factory and machinery market, offering ideal thermal solution, featuring compact sized, easy maintenance design and light weight. The IP65-rated front bezel is specially designed for continuous use in harsh environments. The P1000 series can help customers reduce time-to-market for industry automation.

Selection Guide		307
P1127E-500	12.1" XGA TFT Expandable Industrial Touch Panel Computer with 7th/6th Gen Intel® Core™ i7/i5/i3, Celeron® & Pentium® Processor and PCI/PCIe Slot	309
P1157E-500	15" XGA TFT Expandable Industrial Touch Panel Computer with 7th/6th Gen Intel® Core™ i7/i5/i3, Celeron® & Pentium® Processor and PCI/PCIe Slot	311
P1177E-500	17" SXGA TFT Expandable Industrial Touch Panel Computer with 7th/6th Gen Intel® Core™ i7/i5/i3, Celeron® & Pentium® Processor and PCI/PCIe Slot	313
P1197E-500	19" SXGA TFT Expandable Industrial Touch Panel Computer with 7th/6th Gen Intel® Core™ i7/i5/i3, Celeron® & Pentium® Processor, PCI/PCIe Slot	315

# Industrial Touch Panel Computers

## Selection Guide



Features/Models	P1127E-500	P1157E-500	P1177E-500
<b>CPU Level</b>	LGA1151 socket 6/7th gen Intel® Core™ i7/i5/i3, Celeron® & Pentium®	LGA1151 socket 6/7th gen Intel® Core™ i7/i5/i3, Celeron® & Pentium®	LGA1151 socket 6/7th gen Intel® Core™ i7/i5/i3, Celeron® & Pentium®
<b>Chipset</b>	Intel® H110	Intel® H110	Intel® H110
<b>System Memory</b>	2 x 288-pin DDR4-2133 Long-DIMM dual channel, up to 32GB	2 x 288-pin DDR4-2133 Long-DIMM dual channel, up to 32GB	2 x 288-pin DDR4-2133 Long-DIMM dual channel, up to 32GB
<b>Display</b>	12.1" XGA TFT, 500 nits	15" XGA TFT, 250 nits	17" SXGA TFT, 250 nits
<b>I/O</b>	3 x RS-232 1 x RS-232/422/485 1 x HDMI 1 x VGA 1 x DisplayPort 4 x USB 3.0 2 x USB 2.0 2 x 10/100/1000 Mbps Ethernet 1 x Audio (Mic-in & Line-out) 1 x PS/2 combo 1 x Remote power switch	3 x RS-232 1 x RS-232/422/485 1 x HDMI 1 x VGA 1 x DisplayPort 4 x USB 3.0 2 x USB 2.0 2 x 10/100/1000 Mbps Ethernet 1 x Audio (Mic-in & Line-out) 1 x PS/2 combo 1 x Remote power switch	3 x RS-232 1 x RS-232/422/485 1 x HDMI 1 x VGA 1 x DisplayPort 4 x USB 3.0 2 x USB 2.0 2 x 10/100/1000 Mbps Ethernet 1 x Audio (Mic-in & Line-out) 1 x PS/2 combo 1 x Remote power switch
<b>Storage</b>	1 x 2.5" SATA HDD	1 x 3.5" or 2 x 2.5" SATA HDD	1 x 3.5" or 2 x 2.5" SATA HDD
<b>DVD-RW</b>	N/A	N/A	N/A
<b>Expansion Interface</b>	1 x PCIe x4 or 1 x PCI	1 x PCIe x4 or 1 x PCI	1 x PCIe x4 or 1 x PCI
<b>Touchscreen</b>	5-wire resistive type	5-wire resistive type	5-wire resistive type
<b>Operation System</b>	Skylake: Win 7, Win 8.1, Win 10 Kabylake: Win 10	Skylake: Win 7, Win 8.1, Win 10 Kabylake: Win 10	Skylake: Win 7, Win 8.1, Win 10 Kabylake: Win 10
<b>Power Supply</b>	200W, 100 to 240 VAC	200W, 100 to 240 VAC	200W, 100 to 240 VAC
<b>Power Consumption</b>	121W	97.6W	143W
<b>Watchdog Timer</b>	255 levels, 1 to 255 sec	255 levels, 1 to 255 sec	255 levels, 1 to 255 sec
<b>Front Bezel</b>	Aluminum with IP65/NEMA 4 rugged protection	Aluminum with IP65/NEMA 4 rugged protection	Aluminum with IP65/NEMA 4 rugged protection
<b>Dimensions (W x D x H)</b>	314.2 x 105 x 253.7 mm (12.37" x 4.13" x 9.99")	378.3 x 90 x 310.3 mm (14.89" x 3.54" x 12.22")	411.82 x 90 x 353.24 mm (16.21" x 3.54" x 13.91")
<b>Weight (net/gross)</b>	4.2 kg (9.26 lb)/6.3 kg (13.89 lb)	5.4 kg (11.90 lb)/7.8 kg (17.20 lb)	6.4 kg (14.11 lb)/10.2 kg (22.49 lb)
<b>Operating Temperature</b>	0°C to +50°C (+32°F to +122°F)	0°C to +50°C (+32°F to +122°F)	0°C to +50°C (+32°F to +122°F)
<b>Certifications</b>	CE	CE	CE

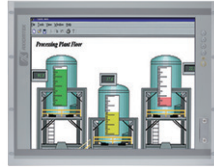

Features/Models	P1197E-500
<b>CPU Level</b>	LGA1151 socket 6/7th Gen Intel® Core™ i7/i5/i3, Celeron® & Pentium®
<b>Chipset</b>	Intel® H110
<b>System Memory</b>	2 x 288-pin DDR4-2133 Long-DIMM dual channel, up to 32GB
<b>Display</b>	19" SXGA TFT, 250 nits
<b>I/O</b>	<ul style="list-style-type: none"> <li>3 x RS-232</li> <li>1 x RS-232/422/485</li> <li>1 x HDMI</li> <li>1 x VGA</li> <li>1 x DisplayPort</li> <li>4 x USB 3.0</li> <li>2 x USB 2.0</li> <li>2 x 10/100/1000 Mbps Ethernet</li> <li>1 x Audio (Mic-in &amp; Line-out)</li> <li>1 x PS/2 combo</li> </ul>
<b>Storage</b>	1 x 3.5" or 2 x 2.5" SATA HDD
<b>DVD-RW</b>	1 x Built-in slim type (optional)
<b>Expansion Interface</b>	1 x PCIe x4 or 1 x PCI
<b>Touchscreen</b>	5-wire resistive type
<b>Operation System</b>	Skylake: Win 7 - Win 8.1 - Win 10 Kabylake: Win 10
<b>Power Supply</b>	200W, 100 to 240 VAC
<b>Power Consumption</b>	157W
<b>Watchdog Timer</b>	255 levels, 1 to 255 sec.
<b>Front Bezel</b>	Aluminum with IP65/NEMA 4 rugged protection
<b>Dimensions (W x D x H)</b>	378 x 72.2 x 309 mm (14.88" x 2.84" x 12.17")
<b>Weight (net/gross)</b>	8 kg (17.64 lb)/10.4 kg (22.93 lb)
<b>Operating Temperature</b>	0°C to +45°C (+32°F to +113°F)
<b>Certifications</b>	CE



Industrial  
Touch Panel  
Computers

# P1127E-500

12.1" XGA TFT Expandable Industrial Touch Panel Computer with 7th/6th Gen Intel® Core™ i7/i5/i3, Celeron® & Pentium® Processor and PCI/PCIe Slot

## Features

- 12.1" XGA TFT LCD display
- LGA1151 socket 7th/6th gen Intel® Core™ i7/i5/i3, Celeron® & Pentium® processors
- Intel® H110 chipset
- Less screw design for easy installation
- 4 USB 3.0, 2 USB 2.0 and 4 COM
- One PCIe x4 or one PCIe slot
- Built-in speakers and optional Wi-Fi 802.11 b/g/n module
- Robust IP65 compliant aluminum front bezel
- Supports 5 OSD keys on the front panel



▲ Side view



▲ Back view



## Introduction

The P1127E-500 is a multimedia 12.1" touch panel PC for kiosk application. It has a fashionable mechanism design and industrial-grade material front bezel which can avoid damage from chemical corrosion. To meet the demands of multimedia application, the P1127E-500 is powered by a high performance LGA1151 socket 7th/6th generation Intel® Core™ processor with the Intel® H110 chipset. It features four COM ports, two Gigabit Ethernet and up to 32GB memory of dual-channel DDR4-2133 that delivers high computing capability for high performance-demanding applications. The industrial touch panel PC is most suitable for kiosk, factory and automation.

### Expandable for 1 PCIe or 1 PCI

The P1127E-500 has one PCIe x4 or one PCI slot for expansion purpose. User can easily plug in standard half-size PCI or PCIe card based on any application needs.

### Speaker and WLAN Antenna Supported

The P1127E-500 features built-in speakers for kiosk application to display multimedia content program. It also supports WLAN module antenna (optional) for wireless network connectivity.

### Friendly Less Screw Design

The P1127E-500 is designed with easy of maintenance in mind. There are only three screws on the back chassis, so that technicians can quickly remove the system's back cover with minimum effort.

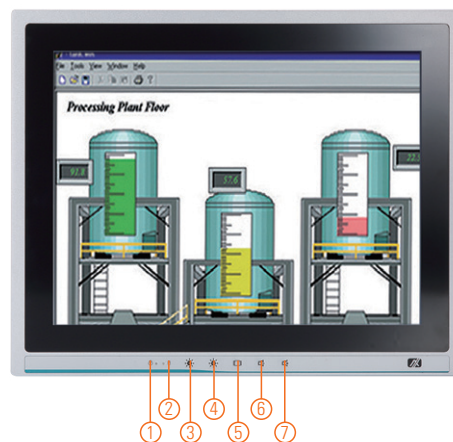

1. Display status LED
2. SATA status LED
3. Brightness -
4. Brightness +
5. Display monitor ON/OFF
6. Volume -
7. Volume +

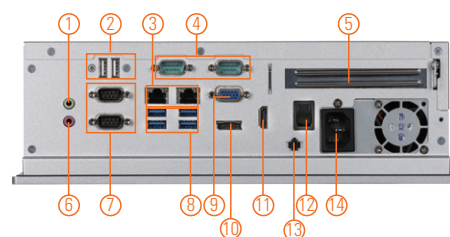

1. 1 x Line-out
2. 2 x USB 2.0
3. 2 x LANs
4. 2 x RS-232
5. PCI or PCIe x4 Card expansion slot
6. 1 x Mic-in
7. 1 x RS-232/422/485 & RS-232
8. 4 x USB 3.0
9. 1 x VGA
10. 1 x DisplayPort
11. 1 x HDMI
12. Switch for power on/off
13. Remote switch button
14. AC plug

## Specifications

Front Bezel	Aluminum w/ IP65/NEMA 4 rugged protection	
LCD Panel	Display Type	12.1" XGA TFT LCD
	Brightness	500 nits
	Resolution	1024 x 768 pixels
	Viewing Angle	160°/140°
Main System	CPU	LGA1151 socket 7th/6th gen Intel® Core™ i7/i5/i3, Celeron® & Pentium® processor
	Chipset	Intel® H110
	System Memory	2 x 288-pin DDR4-2133 Long-DIMM, up to 32GB
	BIOS	AMI UEFI BIOS
	Storage	1 x 2.5" SATA HDD (9.5 mm height)
	Drive	N/A
	Watchdog Timer	255 levels, 1 to 255 sec.

## Specifications

IO Connector	3 x RS-232 1 x RS-232/422/485 1 x HDMI 1 x VGA 1 x DisplayPort 4 x USB 3.0 2 x USB 2.0 2 x 10/100/1000 Mbps Ethernet (Intel® i219-LM/i211-AT) 1 x Audio (Mic-in & Line-out) 1 x Remote Power Switch
TPM	N/A
Expansion Interface	1 x PCIe x4 or 1 x PCI
Touchscreen	5-wire resistive type Light transmission 79% 1 million activations (typical) at a single point
Power Supply	100 to 240 VAC, 200W
Power Consumption	121W
Dimensions	314.2 mm (12.37") (W) x 105 mm (4.13") (D) x 253.7 mm (9.99") (H)
Packing Dimensions	510 mm (20.08") (W) x 190 mm (7.48") (D) x 540 mm (21.26") (H)
Weight(net/gross)	4.2 kg (9.26 lb)/6.3 kg (13.89 lb)
Operating temperature	0°C to +50°C (+32°F to +122°F)
Relative humidity	10% to 90% @ +40°C, non-considering
Operating vibration	1.0G, 5 - 500 Hz, random
Certifications	CE

## Packing list

- 1 x P1127E-500
- 1 x Driver CD
- 1 x Panel mount kit
- 1 x US power cord

## Dimensions

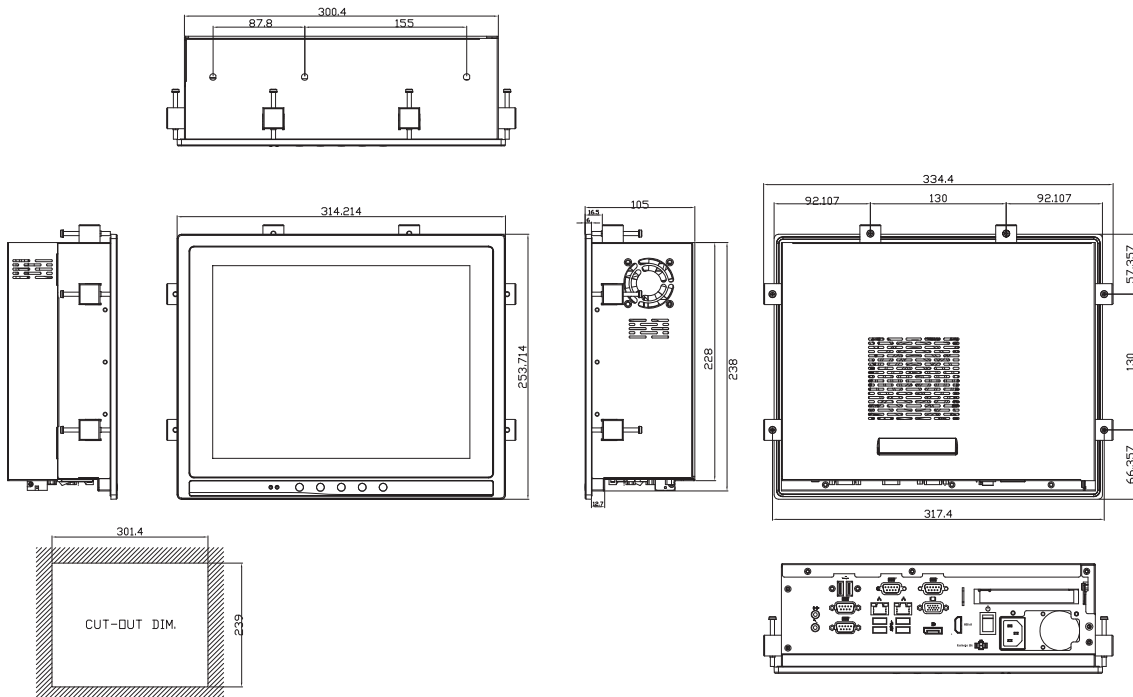

## Ordering Information

P1127E-500 with PCIe	12.1" XGA expandable industrial touch panel computer with LGA1151 socket 7th/6th gen Intel® Core™ i7/i5/i3, Pentium® & Celeron® processor, resistive touch screen, PCIe x4 slot and 100 to 240 VAC
P1127E-500 with PCI	12.1" XGA expandable industrial touch panel computer with LGA1151 socket 7th/6th gen Intel® Core™ i7/i5/i3, Pentium® & Celeron® processor, resistive touch screen, PCI slot and 100 to 240 VAC

\*Specifications and certifications may vary based on different requirements.

## Optional Accessories

Wi-Fi kit	
82211270280E	P1127E-500 VESA & wall mount kit
E981604011	ATC10 (VESA arm clamp type)
E981604012	ATW10 (VESA arm wall mount)
E226171119	PPC S1702B black stand (S)
88121157050E	Remote power switch cable (100 cm)
TBD	P1127E-500 rack mount kit

## Optional EOS Installation

Windows® 7	
Windows® 8.1	
Windows® 10 IoT Enterprise	

## Optional OS Installation

Skylake: Windows® 7	
Windows® 8.1	
Windows® 10	
Kaby Lake: Windows® 10	

# P1157E-500

15" XGA TFT Expandable Industrial Touch Panel Computer with 7th/6th Gen Intel® Core™ i7/i5/i3, Celeron® & Pentium® Processor and PCI/PCIe Slot

## Features

- 15" XGA TFT LCD display
- LGA1151 socket 7th/6th gen Intel® Core™ i7/i5/i3, Celeron® & Pentium® processors
- Intel® H110 chipset
- Less screw design for easy installation
- 4 USB 3.0, 2 USB 2.0 and 4 COM
- One PCIe x4 or one PCIe slot
- Built-in speakers and optional Wi-Fi 802.11 b/g/n module
- Robust IP65 compliant aluminum front bezel
- Supports 5 OSD keys on the front panel



▲ Side view



▲ Back view

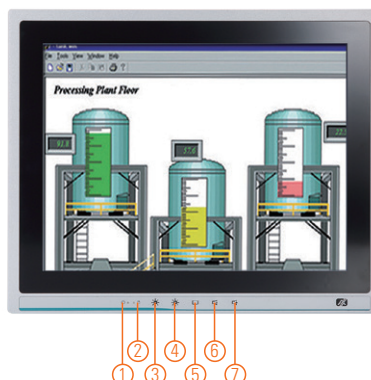

1. Display status LED
2. SATA status LED
3. Brightness -
4. Brightness +
5. Display monitor ON/OFF
6. Volume -
7. Volume +

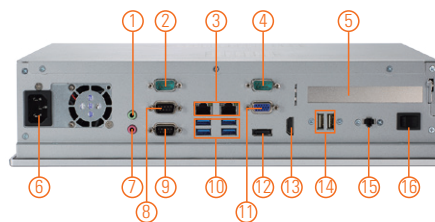

- |                                  |                       |                             |
|----------------------------------|-----------------------|-----------------------------|
| 1. 1 x Line-out                  | 7. 1 x Mic-in         | 13. 1 x HDMI                |
| 2. 1 x RS-232                    | 8. 1 x RS-232/422/485 | 14. 2 x USB 2.0             |
| 3. 2 x LAN                       | 9. 1 x RS-232         | 15. Remote power switch     |
| 4. 1 x RS-232                    | 10. 4 x USB 3.0       | 16. Switch for power on/off |
| 5. PCI or PCIe x4 expansion slot | 11. 1 x VGA           |                             |
| 6. AC plug                       | 12. 1 x DisplayPort   |                             |



## Introduction

The P1157E-500 is a multimedia 15" touch panel PC for kiosk application. It has a fashionable mechanism design and industrial-grade material front bezel which can avoid damage from chemical corrosion. To meet the demands of multimedia application, the P1157E-500 is powered by a high performance LGA1151 socket 7th/6th generation Intel® Core™ processor with the Intel® H110 chipset. It features four COM ports, two Gigabit Ethernet and up to 32GB memory of dual-channel DDR4-2133 that delivers high computing capability for high performance-demanding applications. The industrial touch panel PC is most suitable for kiosk, factory and automation.

### Expandable for 1 PCIe or 1 PCI

The P1157E-500 has one PCIe x4 or PCI slot for expansion purpose. User can easily plug in standard half-size PCI or PCIe card based on any application needs.

### Speaker and WLAN Antenna Supported

The P1157E-500 features built-in speakers for kiosk application to display multimedia content program. It also supports WLAN module antenna (optional) for wireless network connectivity.

### Friendly Less Screw Design

The P1157E-500 is designed with easy of maintenance in mind. There are only four screws on the back chassis, so that technicians can quickly remove the system's back cover with minimum effort.

## Specifications

Front Bezel	Aluminum w/ IP65/NEMA 4 rugged protection
LCD Panel	Display Type 15" XGA TFT LCD
	Brightness 250 nits
	Resolution 1024 x 768 pixels
	Viewing Angle 160°/140°
Main System	CPU LGA1151 socket 7th/6th gen Intel® Core™ i7/i5/i3, Celeron® & Pentium® processor
	Chipset Intel® H110
	System Memory 2 x 288-pin DDR4-2133 Long-DIMM, up to 32GB
	BIOS AMI UEFI BIOS
	Storage 1 x 3.5" or 1 x 2.5" SATA HDD (9.5 mm height)/2 x 2.5" SATA HDD (9.5 mm height) (optional)
	Drive N/A
	Watchdog Timer 255 levels, 1 to 255 sec.



## Specifications

IO Connector	3 x RS-232 1 x RS-232/422/485 1 x HDMI 1 x VGA 1 x DisplayPort 4 x USB 3.0 2 x USB 2.0 2 x 10/100/1000 Mbps Ethernet (Intel® i219-LM/i211-AT) 1 x Audio (Mic-in & Line-out) 1 x Remote power switch
TPM	N/A
Expansion Interface	1 x PCIe x4 or 1 x PCI
Touchscreen	5-wire resistive type Light transmission 79% 1 million activations (typical) at a single point
Power Supply	100 to 240 VAC, 200W
Power Consumption	97.6W
Dimensions	378.3 mm (14.89") (W) x 90 mm (3.54") (D) x 310.3 mm (12.22") (H)
Packing Dimensions	510 mm (20.08") (W) x 186 mm (7.32") (D) x 532 mm (20.94") (H)
Weight (net/gross)	5.4 kg (11.90 lb)/7.8 kg (17.20 lb)
Operating temperature	0°C to +50°C (+32°F to +122°F)
Relative humidity	10% to 90% @ +40°C, non-considering
Operating vibration	1.0G, 5 - 500 Hz, random
Certifications	CE

## Packing list

- 1 x P1157E-500
- 1 x Driver CD
- 1 x Panel mount kit
- 1 x US power cord

## Dimensions

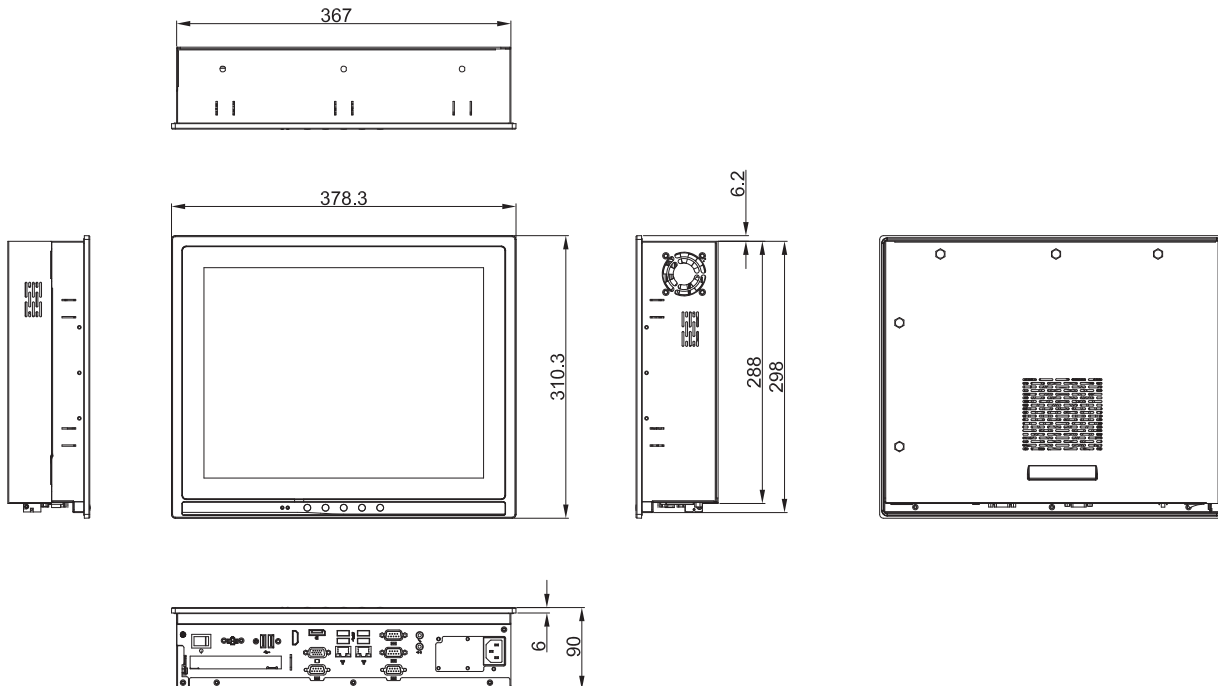

## Ordering Information

P1157E-500 with PCIe	15" XGA expandable industrial touch panel computer with LGA1151 socket 7th/6th gen Intel® Core™ i7/i5/i3, Pentium® & Celeron® processor, resistive touch screen, PCIe x4 slot and 100 to 240 VAC
P1157E-500 with PCI	15" XGA expandable industrial touch panel computer with LGA1151 socket 7th/6th gen Intel® Core™ i7/i5/i3, Pentium® & Celeron® processor, resistive touch screen, PCI slot and 100 to 240 VAC

\*Specifications and certifications may vary based on different requirements.

## Optional Accessories

Wi-Fi kit	
82211570380E	P1157E-500 2.5" slim HDD kit
82211570410E	P1157E-500 rack mount kit
82211570420E	P1157E-500 VESA & wall mount bracket
E981604011	ATC10 (VESA arm clamp type)
E981604012	ATW10 (VESA arm wall mount)
E226171119	PPC S1702B black stand (S)
88121157050E	Remote power switch cable (100 cm)
82211570410E	P1157E-500 rack mount

## Optional EOS Installation

- Windows® 7
- Windows® 8.1
- Windows® 10 IoT Enterprise

## Optional OS Installation

- Skylake: Windows® 7  
Windows® 8.1  
Windows® 10
- Kaby Lake: Windows® 10

# P1177E-500

17" SXGA TFT Expandable Industrial Touch Panel Computer with 7th/6th Gen Intel® Core™ i7/i5/i3, Celeron® & Pentium® Processor and PCI/PCIe Slot

## Features

- 17" SXGA TFT LCD display
- LGA1151 socket 7th/6th gen Intel® Core™ i7/i5/i3, Celeron® & Pentium® processors
- Intel® H110 chipset
- Less screw design for easy installation
- 4 USB 3.0, 2 USB 2.0 and 4 COM
- One PCIe x4 or one PCIe slot
- Built-in speakers and optional Wi-Fi 802.11 b/g/n module
- Robust IP65 compliant aluminum front bezel
- Supports 5 OSD keys on the front panel



▲ Side view



▲ Back view

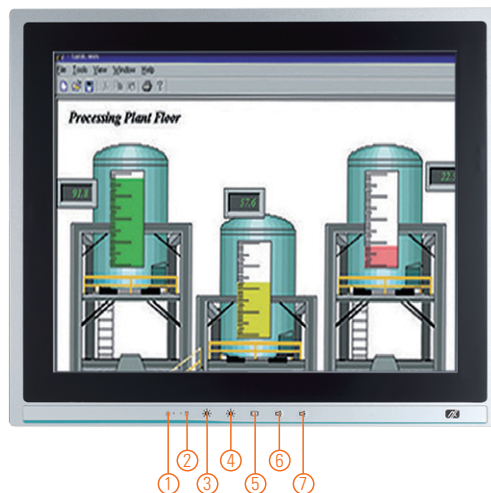

1. Display status LED
2. SATA status LED
3. Brightness -
4. Brightness +
5. Display monitor ON/OFF
6. Volume -
7. Volume +

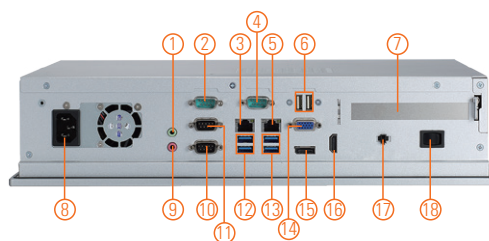

1. 1 x Line-out
2. 1 x RS-232
3. 1 x LAN
4. 1 x RS-232
5. 1 x LAN
6. 2 x USB 2.0
7. PCI or PCIe x4 Card expansion slot
8. AC plug
9. 1 x Mic-in
10. 1 x RS-232
11. 1 x RS-232/422/485
12. 2 x USB 3.0
13. 2 x USB 3.0
14. 1 x VGA
15. 1 x DisplayPort
16. 1 x HDMI
17. Remote switch button
18. Switch for power on/off

## Introduction

The P1177E-500 is a multimedia 17" touch panel PC for kiosk application. It has a fashionable mechanism design and industrial-grade material front bezel which can avoid damage from chemical corrosion. To meet the demands of multimedia application, the P1177E-500 is powered by a high performance LGA1151 socket 7th/6th generation Intel® Core™ processor with the Intel® H110 chipset. It features four COM ports, two Gigabit Ethernet and up to 32GB memory of dual-channel DDR4-2133 that delivers high computing capability for high performance-demanding applications. The industrial touch panel PC is most suitable for kiosk, factory and automation.

### Expandable for 1 PCIe or 1 PCI

The P1177E-500 has one PCIe x4 or one PCI slot for expansion purpose. User can easily plug in standard half-size PCI or PCIe card based on any application needs.

### Speaker and WLAN Antenna Supported

The P1177E-500 is equipped with built-in speakers for multimedia applications. It also supports WLAN module antenna (optional) for wireless network connectivity.

### Friendly Less Screw Design

The P1177E-500 is designed with easy of maintenance in mind. There are only four screws on the back chassis, so that technicians can quickly remove the system's back cover with minimum effort.

## Specifications

Front Bezel	Aluminum w/ IP65/NEMA 4 rugged protection	
LCD Panel	Display Type	17" SXGA TFT LCD
	Brightness	250 nits
	Resolution	1280 x 1024 pixels
	Viewing Angle	160°/140°
Main System	CPU	LGA1151 socket 7th/6th gen Intel® Core™ i7/i5/i3, Celeron® & Pentium® processor
	Chipset	Intel® H110
	System Memory	2 x 288-pin DDR4-2133 Long-DIMM, up to 32GB
	BIOS	AMI UEFI BIOS
	Storage	1 x 3.5" or 1 x 2.5" SATA HDD 2 x 2.5" SATA HDD (9.5 mm height) (optional)
	Drive	N/A
	Watchdog Timer	255 levels, 1 to 255 sec.

## Specifications

IO Connector	3 x RS-232 1 x RS-232/422/485 1 x HDMI 1 x VGA 1 x DisplayPort 4 x USB 3.0 2 x USB 2.0 2 x 10/100/1000 Mbps Ethernet (Intel® i219-LM/i211-AT) 1 x Audio (Mic-in & Line-out) 1 x Remote power switch
TPM	N/A
Expansion Interface	1 x PCIe x4 or 1 x PCI
Touchscreen	5-wire resistive type Light transmission 79% 1 million activations (typical) at a single point
Power Supply	100 to 240 VAC, 200W
Power Consumption	143W
Dimensions	411.82 mm (16.21") (W) x 90 mm (3.54") (D) x 353.24 mm (13.91") (H)
Packing Dimensions	610 mm (24.02") (W) x 260 mm (10.24") (D) x 590 mm (23.23") (H)
Weight (net/gross)	6.4 kg (14.11 lb)/10.2 kg (22.49 lb)
Operating temperature	0°C to +50°C (+32°F to +122°F)
Relative humidity	10% to 90% @ +40°C, non-considering
Operating vibration	1.0G, 5 - 500 Hz, random
Certifications	CE

## Packing list

1 x P1177E-500  
1 x Driver CD  
1 x Panel mount kit  
1 x US power cord

## Dimensions

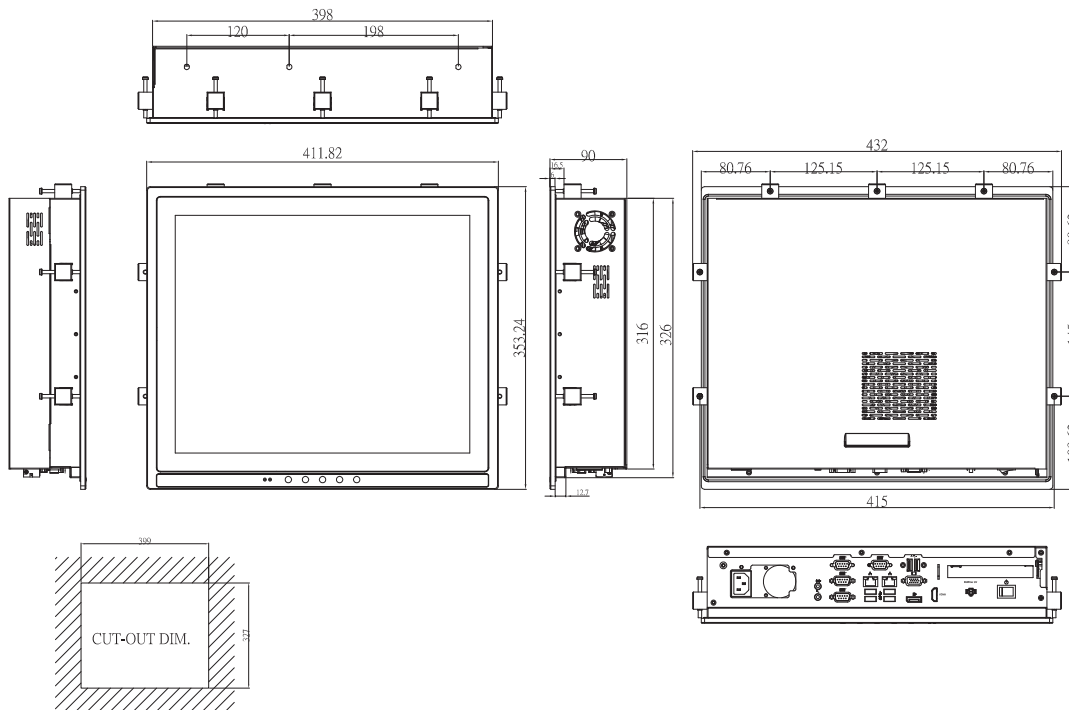

## Ordering Information

P1177E-500 with PCIe	17" SXGA expandable industrial touch panel computer with LGA1151 socket 7th/6th gen Intel® Core™ i7/i5/i3, Pentium® & Celeron® processor, resistive touch screen, PCIe x4 slot and 100 to 240 VAC
P1177E-500 with PCI	17" SXGA expandable industrial touch panel computer with LGA1151 socket 7th/6th gen Intel® Core™ i7/i5/i3, Pentium® & Celeron® processor, resistive touch screen, PCI slot and 100 to 240 VAC

\*Specifications and certifications may vary based on different requirements.

## Optional Accessories

Wi-Fi kit	
82211570380E	P1157E-500 2.5" slim HDD kit supports 15"/17" touch panel PC
82211770360E	P1177E-500 VESA & wall mount bracket
E981604011	ATC10 (VESA arm clamp type)
E981604012	ATW10 (VESA arm wall mount)
E221177116	PPC HA741L black stand (L)
88121157050E	Remote power switch cable (100 cm)
82211770380E	P1177E-500 rack mount kit

## Optional EOS Installation

Windows® 7  
Windows® 8.1  
Windows® 10 IoT Enterprise

## Optional OS Installation

Skylake: Windows® 7  
Windows® 8.1  
Windows® 10  
Kaby Lake: Windows® 10

# P1197E-500

19" SXGA TFT Expandable Industrial Touch Panel Computer with 7th/6th Gen Intel® Core™ i7/i5/i3, Celeron® & Pentium® Processor, PCI/PCIe Slot

## Features

- 19" SXGA TFT LCD display
- LGA1151 socket 7th/6th gen Intel® Core™ i7/i5/i3, Celeron® & Pentium® processor
- Intel® H110 chipset
- Less screw design for easy installation
- 4 USB 3.0, 2 USB 2.0 and 4 COM
- One PCIe x4 or one PCIe expansion slots
- Built-in speakers and optional Wi-Fi 802.11 b/g/n module
- Robust aluminum with IP65 compliant front bezel design

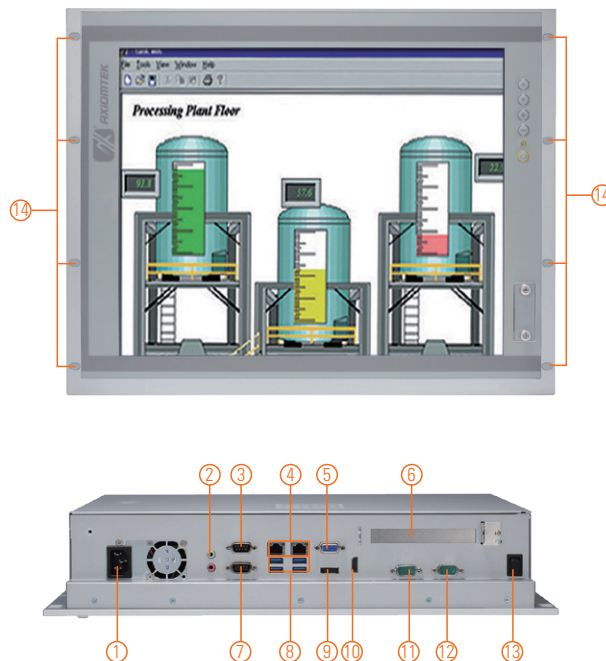
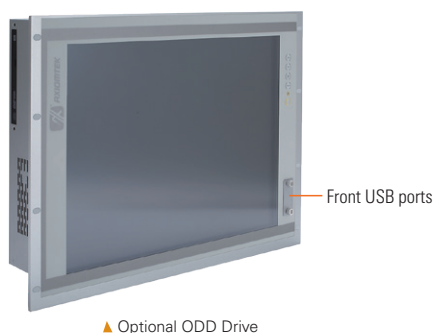

1. AC plug
2. Audio (Mic-in/Line-out)
3. 1 x RS-232/422/485
4. 2 x LAN
5. VGA
6. PCIe x4 or PCI
7. 1 x RS-232
8. 4 x USB 3.0
9. 1 x DisplayPort
10. 1 x HDMI
11. 1 x RS-232
12. 1 x RS-232
13. Power switch
14. Rack mount hole



## Introduction

The P1197E-500 is a multimedia 19" touch panel PC for kiosk application. It has a fashionable mechanism design and industrial-grade material front bezel which can avoid damage from chemical corrosion. To meet the demands of multimedia application, the P1197E-500 is powered by a high performance LGA1151 socket 7th/6th generation Intel® Core™ processor with the Intel® H110 chipset. It features four COM ports, two Gigabit Ethernet and up to 32GB memory of dual-channel DDR4-2133 that delivers high computing capability for high performance-demanding applications. The industrial touch panel PC is most suitable for kiosk, factory and automation.

### Expandable for 1 PCIe or 1 PCI

The P1197E-500 has one PCIe x4 or one PCI slot for expansion purpose. User can easily plug in standard half-size PCI or PCIe card based on any application needs.

### Speaker and WLAN Antenna Supported

The P1197E-500 is equipped with built-in speakers for multimedia applications. It also supports WLAN module antenna (optional) for wireless network connectivity.

### Friendly Less Screw Design

The P1197E-500 is designed with ease of maintenance in mind. There are only three screws on the back chassis, so that technicians can quickly remove the system's back cover with minimum effort.

## Specifications

Front Bezel	Aluminum w/ IP65/NEMA 4 rugged protection
LCD Panel	Display Type 19" SXGA TFT LCD
	Brightness 250 nits
	Resolution 1280 x 1024 pixels
	Viewing Angle 170°/160°
Main System	CPU LGA1151 socket 7th/6th gen Intel® Core™ i7/i5/i3, Celeron® & Pentium® processor
	Chipset Intel® H110
	System Memory 2 x 288-pin DDR4-2133 Long-DIMM, up to 32GB
	BIOS AMI UEFI BIOS
	Storage 1 x 3.5" or 1 x SATA HDD (9.5 mm height)
	Drive 1 x Built-in slim DVD-RW (optional)
	Watchdog Timer 255 levels, 1 to 255 sec.

## Specifications

IO Connector	3 x RS-232 1 x RS-232/422/485 1 x HDMI 1 x VGA 1 x DisplayPort 4 x USB 3.0 2 x USB 2.0 2 x 10/100/1000 Mbps Ethernet (Intel® i219-LM/i211-AT) 1 x Audio (Mic-in & Line-out) 1 x PS/2 Keyboard & mouse combo
TPM	N/A
Expansion Interface	1 x PCIe x4 or 1 x PCI
Touchscreen	5-wire resistive type Light transmission 79% 1 million activations (typical) at a single point
Power Supply	100 to 240 VAC, 200W
Power Consumption	157W
Dimensions	482 mm (18.98") (W) x 94.7 mm (3.73") (D) x 380.8 mm (14.99") (H)
Packing Dimensions	615 mm (24.21") (W) x 250 mm (9.84") (D) x 585 mm (23.03") (H)
Weight(net/gross)	8 kg (17.64 lb)/10.4 kg (22.93 lb)
Operating temperature	0°C to +45°C (+32°F to +113°F)
Relative humidity	10% to 90% @ +40°C, non-considering
Operating vibration	1.0G, 5 - 500 Hz, random
Certifications	CE

## Packing list

- 1 x P1197E-500
- 1 x Driver CD
- 1 x Panel mount kit
- 1 x US power cord

## Dimensions

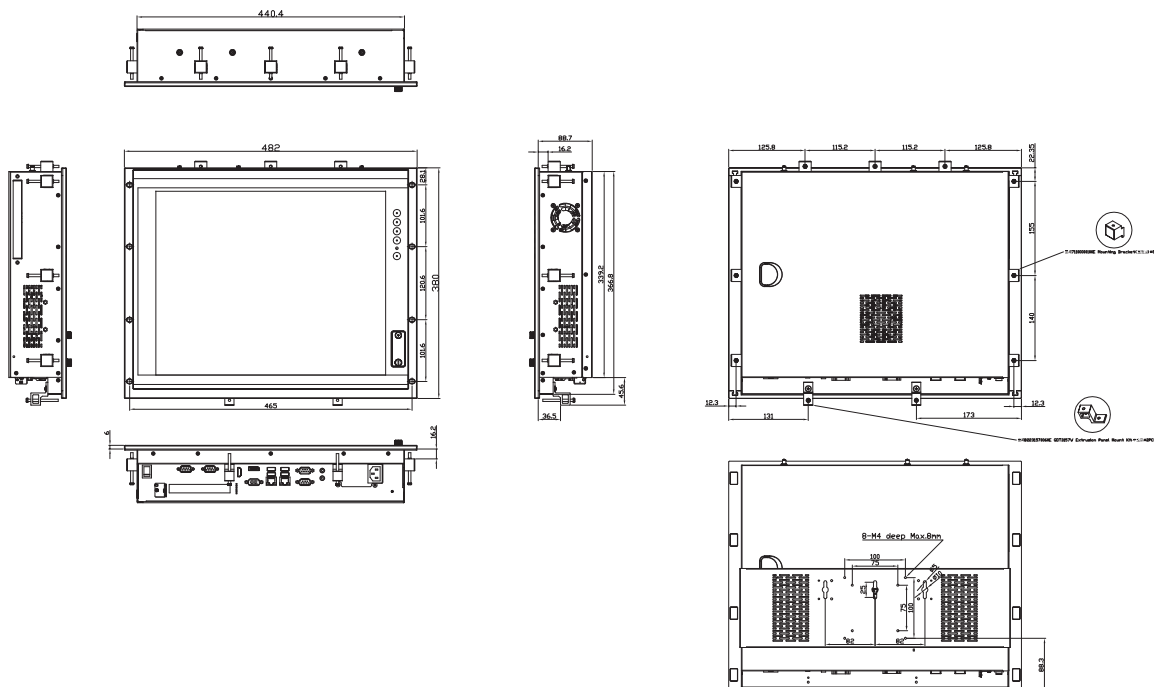

## Ordering Information

P1197E-500 with PCIe	19" SXGA expandable industrial touch panel computer with LGA1151 socket 7th/6th gen Intel® Core™ i7/i5/i3, Pentium® & Celeron® processor, resistive touch screen, PCIe x4 slot and 100 to 240 VAC
P1197E-500 with PCI	19" SXGA expandable industrial touch panel computer with LGA1151 socket 7th/6th gen Intel® Core™ i7/i5/i3, Pentium® & Celeron® processor, resistive touch screen, PCI slot and 100 to 240 VAC

\*Specifications and certifications may vary based on different requirements.

## Optional Accessories

Wi-Fi kit	
82211970070E	VESA & wall mount kit
E981604011	ATC10 (VESA arm clamp type)
E981604012	ATW10 (VESA arm wall mount)
E221177116	PPC HA741L black stand (L)

## Optional EOS Installation

Windows® 10 IoT Enterprise

## Optional OS Installation

Windows® 10



▲ Less screw design



Fanless Touch Panel Computers

Heavy-duty Fanless Touch Panel Computers

Vehicle Mount Terminal Computer

Stainless Touch Panel Computers

Transportation Touch Panel Computers and Displays

Industrial Touch Panel Computers

Industrial Touch Monitors

Medical Panel Computers

Open Frame Panel Computer

# Industrial Panel PCs



# 7

## Industrial Touch Monitors

The P6000 product series offers flexible options of resistive or projective capacitive touch screens for ease and practicality of use. The P6000 products are ideal solutions for use in industrial automation and control systems, building automation, machinery manufacturing environments, self-service kiosks, and other HMI applications.

Selection Guide		319
P6157W-V2	15.6" WXGA TFT Widescreen Industrial LCD Monitor	321
P6171-V2	17" SXGA TFT Industrial LCD Monitor	323
P6187W-V2	18.5" WXGA TFT Widescreen Industrial LCD Monitor	325
P6217W	21.5" FHD TFT Widescreen Industrial LCD Monitor	327

# Industrial Touch Monitors

## Selection Guide



Features/Models	P6157W-V2	P6171-V2	P6187W-V2
<b>Display Type</b>	15.6" WXGA TFT Flat front bezel (NEMA 4/12)	17" SXGA TFT, aluminum front bezel NEMA 4/12 & IP65	18.5" WXGA TFT Flat front bezel (NEMA 4/12)
<b>Max. Colors</b>	16.7M	16.2M	16.7M
<b>Active Area (mm)</b>	344.232 x 193.536	337.920 x 270.336	409.8 x 230.4
<b>Max. Resolution</b>	1366 x 768	1280 x 1024	1366 x 768
<b>Display Mode</b>	VGA 640 x 480 (60/72/75 Hz) SVGA 800 x 600 (56/60/75 Hz) XGA 1024 x 768 (60/70/75 Hz) SXGA 1280 x 1024 (60/70/75 Hz) WXGA 1366 x 768 (60 Hz)	VGA 640 x 350 (70 Hz) VGA 640 x 480 (60/72/75 Hz) VGA 720 x 400 (70 Hz) SVGA 800 x 600 (60/72/75 Hz) XGA 1024 x 768 (60/72/75 Hz) SXGA 1280 x 1024 (60/72/75 Hz)	VGA 640 x 350 (70 Hz) VGA 720 x 400 (70 Hz) VGA 640 x 480 (60/72/75 Hz) SVGA 800 x 600 (60/72/75 Hz) XGA 1024 x 768 (60/70/75 Hz) WXGA 1366 x 768 (60 Hz)
<b>Pixel Pitch (H x V, mm)</b>	0.252 x 0.252	0.264 x 0.264	0.3 x 0.3
<b>Backlight</b>	LED	LED	LED
<b>Backlight MTBF (hrs)</b>	50,000	30,000	50,000
<b>Viewing Angle (H/V)</b>	170°/160°	170°/160°	170°/160°
<b>Response Time</b>	8ms	5ms	5ms
<b>Contrast Ratio</b>	500 (TYP)	1000 (TYP)	1000 (TYP)
<b>Brightness (cd/m<sup>2</sup>)</b>	400 nits	250 nits	450 nits
<b>Display Control</b>	OSD	OSD	OSD
<b>I/O Connectors</b>	1 x DC power input 1 x RS-232 or USB for touch 1 x VGA 1 x HDMI 1 x DVI-D 1 x Line-in	1 x DC power input 1 x RS-232 or USB for touch 1 x VGA 1 x HDMI 1 x DVI-D 1 x Line-in	1 x DC power input 1 x RS-232 or USB for touch 1 x VGA 1 x HDMI 1 x DVI-D 1 x Line-in
<b>Touchscreen</b>	Capacitive type 10-point projected capacitive multi-touch	Resistive type	Capacitive multi-touch
<b>Power Consumption</b>	19W	24W	22W
<b>Power Adapter</b>	Screw-type external AC/DC power adapter	Screw-type external AC/DC power adapter	Screw-type external AC/DC power adapter
<b>Dimensions (W x D x H)</b>	397 x 247 x 54 mm (15.63" x 9.72" x 2.13")	410.31 x 28 x 38.31 mm (16.15" x 1.10" x 13.32")	460 x 57 x 285 mm (18.11" x 2.44" x 11.22")
<b>Weight (net/gross)</b>	4.5 kg (9.92 lb)/6.5 kg (14.33 lb)	3.8 kg (8.38 lb)/6.56 kg (14.46 lb)	6.0 kg (12.22 lb)/7.35 kg (16.20 lb)
<b>Operating Temperature</b>	0°C to +55°C (+32°F to +131°F)	0°C to +45°C (+32°F to +113°F)	0°C to +55°C (+32°F to +131°F)
<b>Mounting</b>	Panel mount/wall mount/ VESA mount	Panel mount/wall mount/rackmount/ VESA mount	Panel mount/wall mount/VESA arm
<b>Certifications</b>	CE	CE	CE



Features/Models	P6217W
<b>Display Type</b>	21.5" FHD TFT Flat front bezel (NEMA 4/12)
<b>Max. Colors</b>	16.7M
<b>Active Area (mm)</b>	476.64 x 268.11
<b>Max. Resolution</b>	1920 x 1080
<b>Display Mode</b>	VGA 640 x 350 (70 Hz) VGA 720 x 400 (70 Hz) VGA 640 x 480 (60/72/75 Hz) SVGA 800 x 600 (60/72/75 Hz) XGA 1024 x 768 (60/70/75 Hz) WXGA 1366 x 768 (60 Hz) FHD 1920 x 1080 (60 Hz)
<b>Pixel Pitch (H x V, mm)</b>	0.24 x 0.24
<b>Backlight</b>	LED
<b>Backlight MTBF (hrs)</b>	50,000
<b>Viewing Angle (H/V)</b>	178°/178°
<b>Response Time</b>	18ms
<b>Contrast Ratio</b>	3000 (TYP)
<b>Brightness (cd/m<sup>2</sup>)</b>	250 nits
<b>Display Control</b>	OSD
<b>I/O Connectors</b>	1 x DC power input 1 x RS-232 or USB for touch 1 x VGA 1 x HDMI 1 x DVI-D 1 x Line-in
<b>Touchscreen</b>	Capacitive type 10-point projected capacitive multi-touch
<b>Power Consumption</b>	20W
<b>Power Adapter</b>	Screw-type external AC/DC power adapter
<b>Dimensions (W x D x H)</b>	547.59 x 53 x 339.05 mm (21.56" x 2.09" x 13.34")
<b>Weight (net/gross)</b>	6.42 kg (14.15 lb)/7.78 kg (17.15 lb)
<b>Operating Temperature</b>	0°C to +45°C (+32°F to +113°F)
<b>Mounting</b>	Panel mount/wall mount/VESA arm
<b>Certifications</b>	CE



# P6157W-V2

15.6" WXGA TFT Widescreen Industrial LCD Monitor

## Features

- 15.6" WXGA TFT 400 nits LCD with projective capacitive multi-touch
- NEMA 4/12 (IP65) compliant flat panel monitor
- Supports panel mount, wall mount and VESA mount
- Full range screw-type (locked) AC-in or 24V DC-in (optional)
- VGA, HDMI and DVI with multi-signal inputs

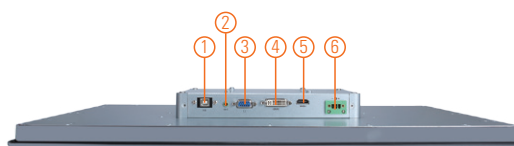
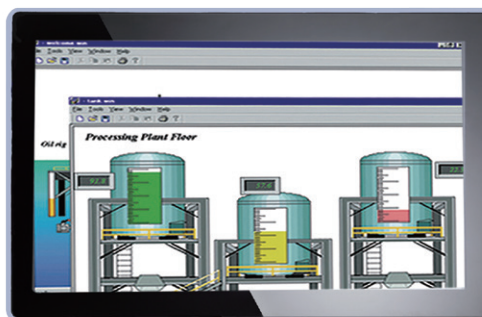
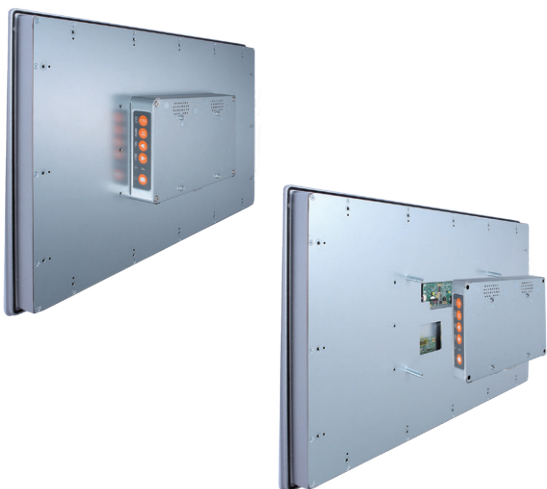

1. T/S port
2. Line-in
3. VGA
4. DVI-D
5. HDMI
6. Screw type or Phoenix type power input

## Introduction

The P6157W-V2 is a slim-type industrial LCD monitor with flat front bezel design, which adopts 15.6-inch 300 nits full HD LCD display and supports multi-signal interfaces including DVI, VGA and HDMI. Featuring IP65 (NEMA 4)-rated front bezel, screw-type adaptor plug design, and 12/24V DC-in, the 15.6-inch P6157W-V2 is designed to fit for all kinds of industrial environments. Moreover, the P6157W-V2 supports panel mount, wall mount or VESA FPMPMI (Video Electronics Standards Association Flat Panel Monitor Physical Mounting Interface) mounting. With the compact mechanism design, the P6157W-V2 can be deployed easily in any space-limited place. It is especially suitable for POI/POS, HMI and all kinds of heavy-duty industrial fields.

## Specifications

Front Bezel	NEMA 4/12 (IP65)-compliant, flat front bezel	
Mounting	Panel mount, wall mount and VESA arm FPMPMI mounting (video electronics standards association Flat Panel monitor physical mounting interface)	
LCD Panel	Display	15.6" WXGA TFT LCD
	Max. Resolution	1366 x 768
	Max. Colors	16.7 M
	Active Area (mm)	344.232 x 193.536
	Pixel Pitch (mm)	0.252 x 0.252
	Response Time	8 ms
	Backlight	LED
	Backlight MTBF	50,000 hrs
	Viewing Angle (H/V)	170°/160°
	Contrast Ratio	500 (TYP.)
Brightness (cd/m <sup>2</sup> )	400 nits	
Display Control	OSD (on screen display)	
Display Mode	VGA 640 x 350 (70 Hz), VGA 640 x 480 (60/72/75 Hz), VGA 720 x 400 (70 Hz), SVGA 800 x 600 (60/72/75 Hz), XGA 1024 x 768 (60/72/75 Hz), WXGA 1366 x 768 (60 Hz)	
Input Signal	VGA HDMI DVI (only for DVI-D) Touchscreen: USB interface	

## Specifications

I/O Connectors	1 x USB for touchscreen version 1 x Audio (Line-in) 1 x VGA 1 x HDMI 1 x DVI 1 x Screw type or Phoenix type power input
Power Adapter	Screw-type external AC/DC power adapter
Power Consumption	16W
Touchscreen	Multi-touch projective capacitive (optional)
Dimensions	396.8mm (15.62") (W) x 247.1mm (9.73") (D) x 54mm (2.13") (H)
Packing Dimensions	505 mm (19.88") (W) x 166 mm (6.53") (D) x 440 mm (17.32") (H)
Weight (net/gross)	3.9 kg (8.598 lb)/5.88 kg (12.963 lb)
Operating temperature	0°C to +50°C (+32°F to +131°F)
Relative humidity	20% to 90% @ +40°C, non-condensing
Certifications	CE

## Packing List

- 1 x P6157W-V2 unit
- 1 x VGA cable
- 1 x USB cable or RS-232 cable (for resistive touch version only)
- 1 x Audio cable
- 1 x Driver CD

## Ordering Information

P6157W-V2		
AC Power	Panel mount monitor	
	Capacitive (USB)	P6157WPC-AC-U-US-EU-V2
	Glass	P6157WPG-AC-US-EU-V2
24VDC Power	Panel mount monitor	
	Capacitive (USB)	P6157WPC-24VDC-U-V2
	Glass	P6157WPG-24VDC-V2

## Optional Accessories

5946L203800E	HDMI cable
5946L1713400E	DVI cable
82261570240E	Panel mount kit
82231770050E	Wall mount kit
E221177116	Desktop stand for 15.6" to 21.5"

\*Specifications and certifications may vary based on different requirements.

## Dimensions

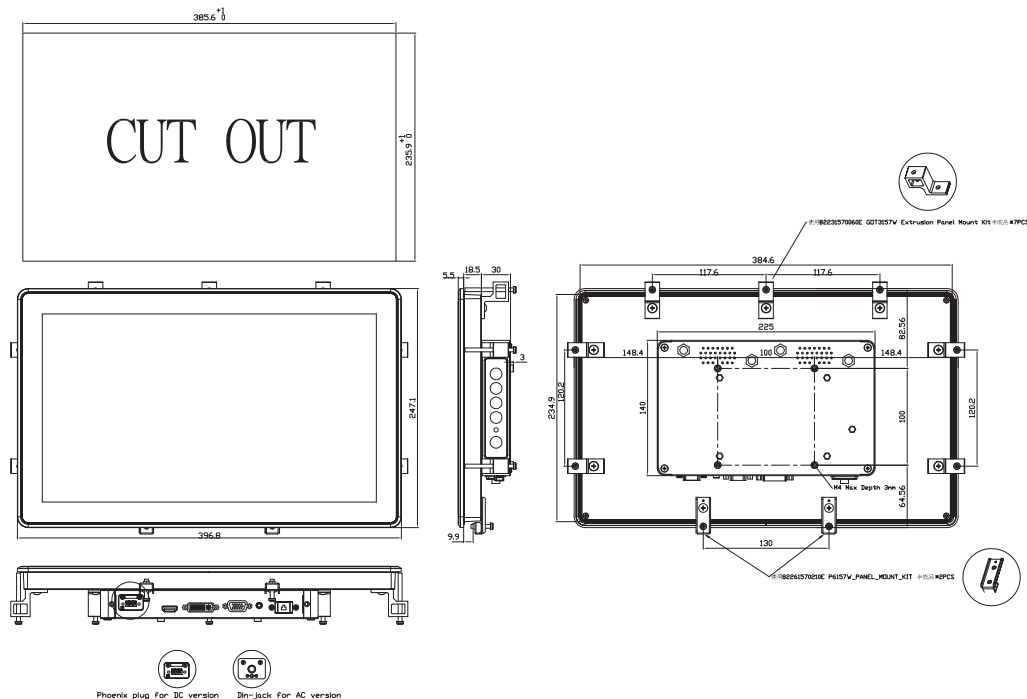

# P6171-V2

17" SXGA TFT Industrial LCD Monitor

## Features

- 17" SXGA TFT LED backlight LCD
- NEMA 4/12 (IP65) compliant flat panel monitor
- Supports panel mount, wall mount, rack mount and VESA arm
- Resistive touchscreen
- Full range screw-type (locked) AC-in or 12V/24V DC-in (option)
- HDMI, DVI-D and VGA with multi signal inputs



▲ Ultra-slim mechanism design

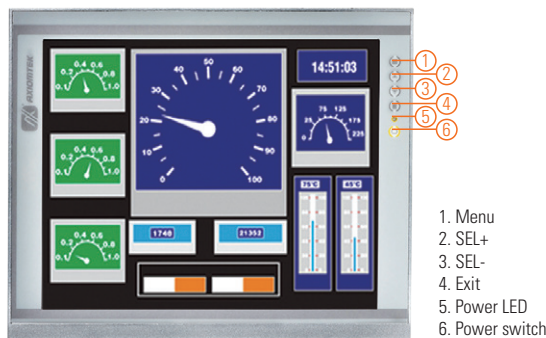

1. Menu
2. SEL+
3. SEL-
4. Exit
5. Power LED
6. Power switch

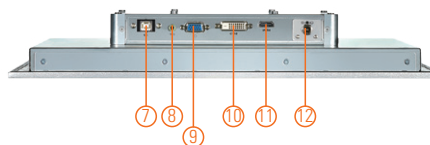

7. RS-232 or USB for Touch
8. Line-in
9. VGA
10. DVI-D
11. HDMI
12. Screw type or Phoenix type power input

## Introduction

The P6171 is an ultra slim industrial LCD monitor, which adopts 17-inch 250 nits SXGA LED backlight LCD display and supports multi-signal interfaces including DVI, DisplayPort and HDMI. Featuring NEMA 4/12 & IP65 compliant front bezel, screw-type adaptor plug design, and 12/24V DC-in means it is fit for all kinds of industrial environments. Moreover, the P6171 supports panel mount, wall mount, rack mount or VESA FPMPMI (Video Electronics Standards Association Flat Panel Monitor Physical Mounting Interface) mounting. With the compact mechanism design, users can enjoy free from space constraint. It is especially suitable for POI/POS, excellent HMI and all kinds of heavy-duty industrial fields.

## Specifications

Front Bezel	NEMA 4/12 (IP65)-compliant, metal front bezel	
Mounting	Panel mount, wall mount, rackmount or VESA arm FPMPMI mounting (video electronics standards association Flat Panel monitor physical mounting interface)	
LCD Panel	Display	17" SXGA TFT LCD
	Max. Resolution	1280 x 1024
	Max. Colors	16.2 M
	Active Area (mm)	337.92 x 270.33
	Pixel Pitch (mm)	0.264 x 0.264
	Response Time	5ms
	Backlight	LED backlight
	Backlight MTBF	30,000 hrs
	Viewing Angle (H/V)	170°/160°
Display Control	OSD (on screen display)	
	Display Mode	VGA 640 x 350 (70Hz), VGA 640 x 480 (60/72/75Hz), VGA 720 x 400 (70Hz), SVGA 800 x 600 (60/72/75Hz), XGA 1024 x 768 (60/72/75Hz), SXGA 1280 x 1024 (60/72/75Hz)
	Input Signal	DVI-D VGA HDMI Touchscreen: Serial RS-232 or USB interface



## Specifications

I/O Connectors	1 x RS-232 or USB for touchscreen version 1 x DVI-D 1 x VGA 1 x HDMI 1 x Screw-type DC power input	
Power Adapter	Screw-type external AC/DC power adapter	
Power Consumption	24W	
Touchscreen	Thickness	Resistive: 3.2 mm
	Light Transmission	Resistive: 80%
	Power Consumption	Resistive: +5V @ 100mA
	Touch Life	Resistive: 35 million touches Controller Interface: RS-232 D-type 9-pin male connector or USB
Dimensions	410.31 mm (16.15") (L) x 58 mm (2.28") (H) x 338.31 mm (13.32") (W)	
Packing Dimensions	510 mm (20.08") (L) x 532 mm (20.94") (H) x 186 mm (7.32") (W)	
Weight (net/gross)	3.8 kg (8.38 lb)/6.56 kg (14.46 lb)	
Operating Temperature	0°C to +45°C (+32°F to +113°F)	
Relative Humidity	20% to 90% @ +40°C, non-condensing	
Certifications	CE	

## Packing List

- 1 x P6171 unit
- 1 x VGA cable
- 1 x USB cable or RS-232 cable (for resistive touch version only)
- 1 x Adaptor (for AC version only)
- 1 x Audio cable
- 1 x Driver CD

## Ordering Information

AC Power	Resistive (RS-232)	P6171PR-AC-RS-US-EU-V2
	Resistive (USB)	P6171PR-AC-U-US-EU-V2
	Glass	P6171PG-AC-US-EU-V2
12V/24VDC Power	Resistive (RS-232)	P6171PR-24VDC-RS-V2
	Resistive (USB)	P6171PR-24VDC-U-V2
	Glass	P6171PG-24VDC-V2

## Optional Accessories

5946L203800E	HDMI cable
5946L1713400E	DVI cable
82231770050E	Wall mount kit
82261710120E	Panel mount kit
82261710170E	Rack mount kit
E221177116	Desktop stand for 15.6" to 21.5"

\*Specifications and certifications may vary based on different requirements.

## Dimensions

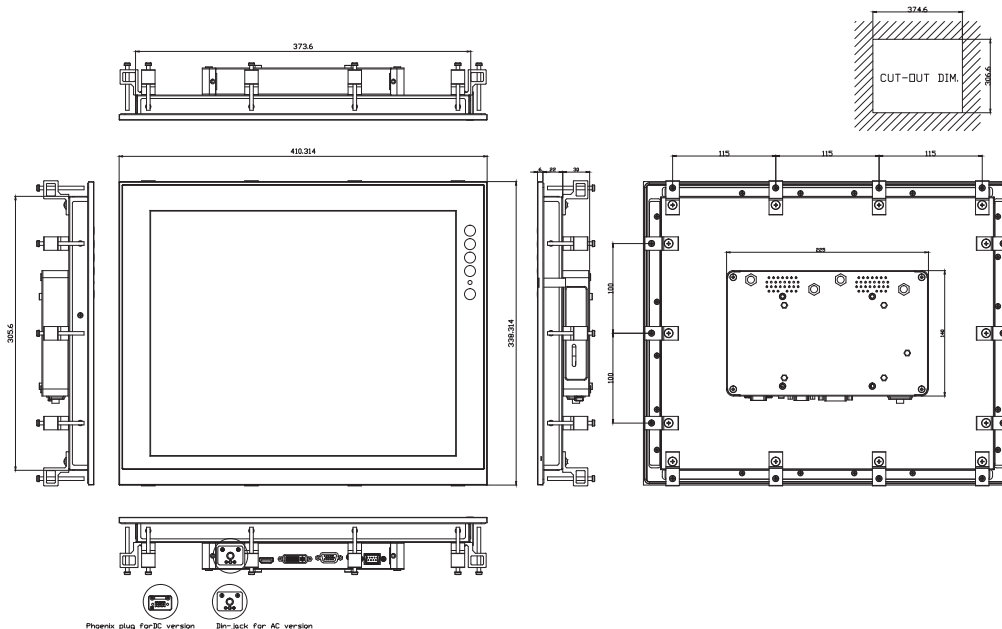

# P6187W-V2

18.5" WXGA TFT Widescreen Industrial LCD Monitor

## Features

- 18.5" WXGA TFT 450 nits LCD with projective capacitive multi-touch
- NEMA 4/12 (IP65) compliant flat panel monitor
- Supports panel mount, wall mount and VESA mount
- Full range screw-type (locked) AC-in or 24V DC-in (optional)
- VGA, HDMI and DVI with multi-signal inputs

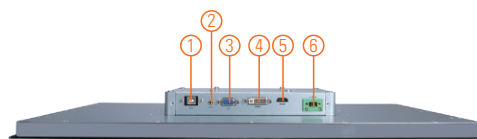
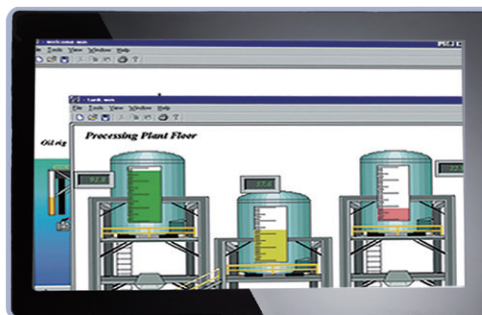
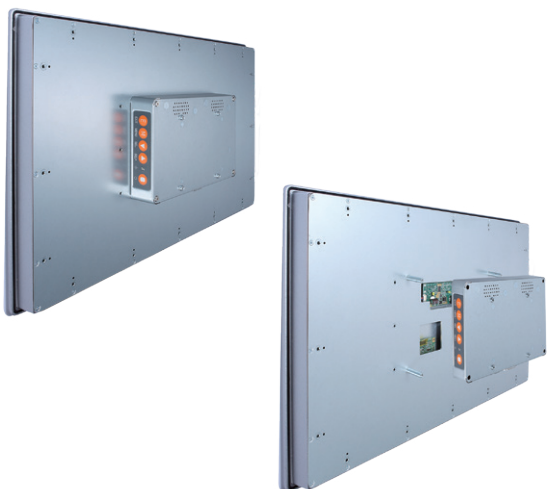

1. T/S port
2. Line-in
3. VGA
4. DVI-D
5. HDMI
6. Screw type or Phoenix type power input

## Introduction

The P6187W-V2 is a slim-type industrial LCD monitor with flat front bezel design, which adopts 18.5-inch 300 nits full HD LCD display and supports multi-signal interfaces including DVI, VGA and HDMI. Featuring IP65 (NEMA 4)-rated front bezel, screw-type adaptor plug design, and 12/24V DC-in, the 18.5-inch P6187W-V2 is designed to fit for all kinds of industrial environments. Moreover, the P6187W-V2 supports panel mount, wall mount or VESA FPMPMI (Video Electronics Standards Association Flat Panel Monitor Physical Mounting Interface) mounting. With the compact mechanism design, the P6187W-V2 can be deployed easily in any space-limited place. It is especially suitable for POI/POS, HMI and all kinds of heavy-duty industrial fields.

## Specifications

Front Bezel	NEMA 4/12 (IP65)-compliant, flat front bezel	
Mounting	Panel mount, wall mount and VESA arm FPMPMI mounting (video electronics standards association Flat Panel monitor physical mounting interface)	
LCD Panel	Display	18.5" WXGA TFT LCD
	Max. Resolution	1366 x 768
	Max. Colors	16.7 M
	Active Area (mm)	409.8 x 230.4
	Pixel Pitch (mm)	0.3 x 0.3
	Response Time	5 ms
	Backlight	LED
	Backlight MTBF	50,000 hrs
	Viewing Angle (H/V)	170°/160°
	Contrast Ratio	1000 (TYP.)
Brightness (cd/m <sup>2</sup> )	450 nits	
Display Control	OSD (on screen display)	
Display Mode	VGA 640 x 350 (70 Hz), VGA 640 x 480 (60/72/75 Hz), VGA 720 x 400 (70 Hz), SVGA 800 x 600 (60/72/75 Hz), XGA 1024 x 768 (60/72/75 Hz), WXGA 1366 x 768 (60 Hz)	
Input Signal	VGA HDMI DVI (only for DVI-D) Touchscreen: USB interface	

## Specifications

I/O Connectors	1 x USB for touchscreen version 1 x Audio (Line-in) 1 x VGA 1 x HDMI 1 x DVI 1 x Screw type or Phoenix type power input
Power Adapter	Screw-type external AC/DC power adapter
Power Consumption	16W
Touchscreen	Multi-touch projective capacitive (optional)
Dimensions	460 mm (18.11") (W) x 285 mm (11.22") (D) x 58.45 mm (2.30") (H)
Packing Dimensions	575 mm (22.63") (W) x 170 mm (6.69") (D) x 460 mm (18.11") (H)
Weight (net/gross)	4.83 kg (10.63 lb)/6.33 kg (13.93 lb)
Operating Temperature	0°C to +55°C (+32°F to +131°F)
Relative Humidity	20% to 90% @ +40°C, non-condensing
Certifications	CE

## Packing List

1 x P6187W-V2 unit
1 x VGA cable
1 x USB cable or RS-232 cable (for resistive touch version only)
1 x Audio cable
1 x Driver CD

## Ordering Information

P6187W-V2		
AC Power	Panel mount monitor	
	Capacitive (USB)	P6187WPC-AC-U-US-EU-V2
	Glass	P6187WPG-AC-US-EU-V2
24VDC Power	Panel mount monitor	
	Capacitive (USB)	P6187WPC-24VDC-U-V2
	Glass	P6187WPG-24VDC-V2

## Optional Accessories

5946L203800E	HDMI cable
59461713400E	DVI cable
82261870070E	Panel mount kit
82231770050E	Wall mount kit
E221177116	Desktop stand for 15.6" to 21.5"

\*Specifications and certifications may vary based on different requirements.

## Dimensions

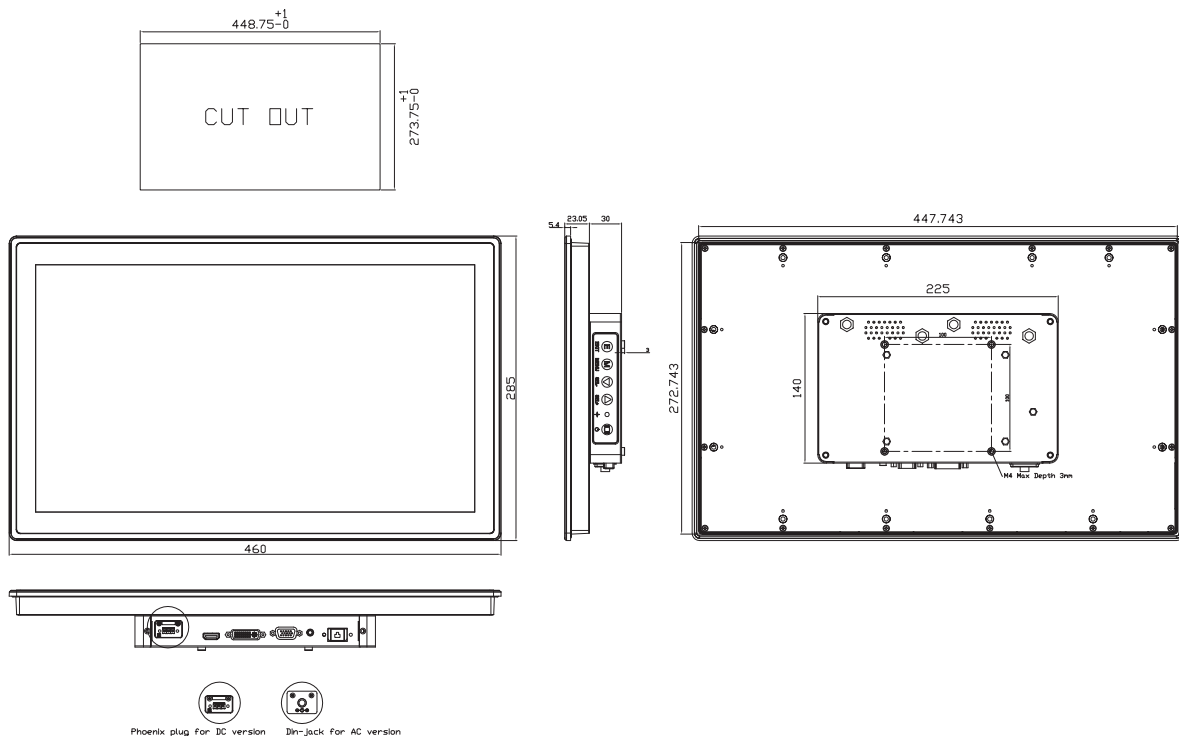

# P6217W

21.5" FHD TFT Widescreen Industrial LCD Monitor

## Features

- 21.5" FHD TFT 250 nits with projective capacitive multi-touch
- NEMA 4/12 (IP65) compliant flat panel monitor
- Supports panel mount, wall mount and VESA mount
- Full range screw-type (locked) AC-in or 24V DC-in (optional)
- VGA, HDMI and DVI with multi-signal inputs

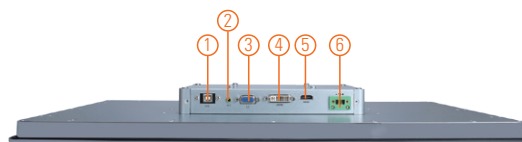
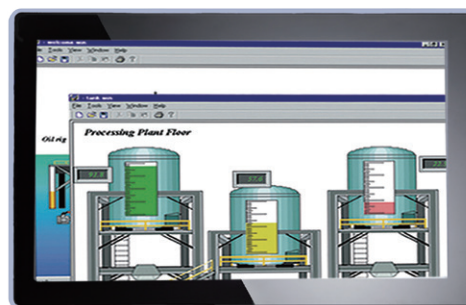
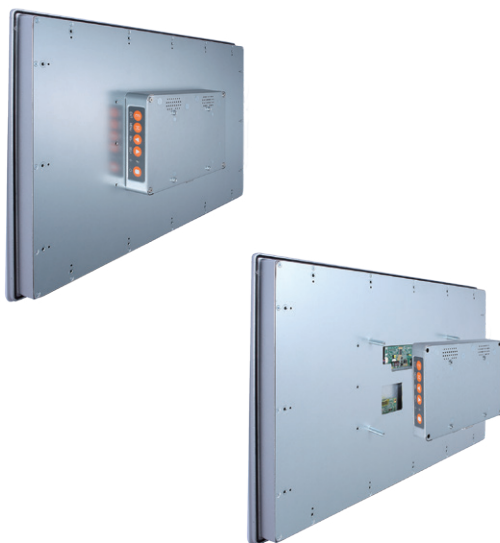

1. T/S port
2. Line-in
3. VGA
4. DVI-D
5. HDMI
6. Screw type or Phoenix type power input

## Introduction

The P6217W is a slim-type industrial LCD monitor with flat front bezel design, which adopts 21.5-inch 250 nits full HD LCD display and supports multi-signal interfaces including DVI, VGA, S-Video, Video. Featuring IP65 (NEMA 4)-rated front bezel, screw-type adaptor plug design, and 12/24V DC-in, the 21.5-inch P6217W is designed to fit for all kinds of industrial environments. Moreover, the P6217W supports panel mount, wall mount or VESA FPMPMI (Video Electronics Standards Association Flat Panel Monitor Physical Mounting Interface) mounting. With the compact mechanism design, the P6217W can be deployed easily in any space-limited place. It is especially suitable for POI/POS, HMI and all kinds of heavy-duty industrial fields.

## Specifications

Front Bezel	NEMA 4/12 (IP65)-compliant, flat front bezel	
Mounting	Panel mount, wall mount and VESA arm FPMPMI mounting (video electronics standards association Flat Panel monitor physical mounting interface)	
LCD Panel	Display	21.5" FHD TFT LCD
	Max. Resolution	1920 x 1080
	Max. Colors	16.7 M
	Active Area (mm)	476.64 x 268.11
	Pixel Pitch (mm)	0.24 x 0.24
	Response Time	18 ms
	Backlight	LED
	Backlight MTBF	50,000 hrs
	Viewing Angle (H/V)	178°/178°
	Contrast Ratio	3000 (TYP.)
Brightness (cd/m <sup>2</sup> )	250 nits	
Display Control	OSD (on screen display)	
Display Mode	VGA 640 x 350 (70 Hz), VGA 640 x 480 (60/72/75 Hz), VGA 720 x 400 (70 Hz), SVGA 800 x 600 (60/72/75 Hz), XGA 1024 x 768 (60/72/75 Hz), WXGA 1366 x 768 (60 Hz), FHD 1920 x 1080 (60 Hz)	
Input Signal	VGA HDMI DVI (only for DVI-D) Touchscreen: USB interface	

## Specifications

I/O Connectors	1 x USB for touchscreen version 1 x Audio (Line-in) 1 x VGA 1 x HDMI 1 x DVI 1 x Screw type or Phoenix type power input
Power Adapter	Screw-type external AC/DC power adapter
Power Consumption	20W
Touchscreen	Multi-touch projective capacitive (optional)
Dimensions	547.59 mm (21.56") (W) x 339.05 mm (13.34") (D) x 53 mm (2.09") (H)
Packing Dimensions	700 mm (27.56") (W) x 185 mm (7.28") (D) x 510 mm (20.07") (H)
Weight (net/gross)	6.42 kg (14.15 lb)/7.78 kg (17.15 lb)
Operating Temperature	0°C to +45°C (+32°F to +113°F)
Relative Humidity	20% to 90% @ +40°C, non-condensing
Certifications	CE

## Packing List

1 x P6217W unit
1 x VGA cable
1 x USB cable or RS-232 cable (for resistive touch version only)
1 x Audio cable
1 x Driver CD

## Ordering Information

P6217W		
AC Power	Panel mount monitor	
	Capacitive (USB)	P6217WPC-AC-U-US-EU
	Glass	P6217WPG-AC-US-EU
24VDC Power	Panel mount monitor	
	Capacitive (USB)	P6217WPC-24VDC-U
	Glass	P6217WPG-24VDC

## Optional Accessories

5946L203800E	HDMI cable
59461713400E	DVI cable
82262170000E	Panel mount kit
82231770050E	Wall mount kit
E221177116	Desktop stand for 15.6" to 21.5"

\*Specifications and certifications may vary based on different requirements.

## Dimensions

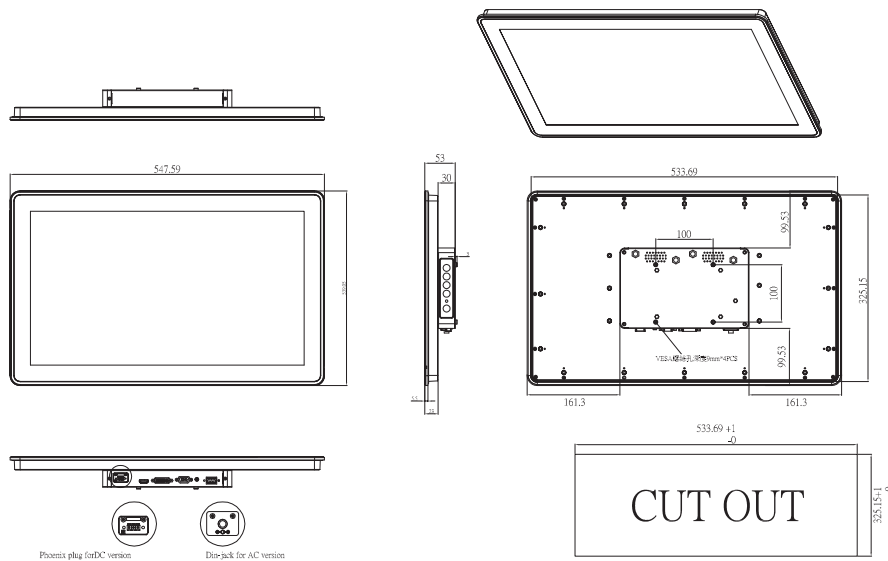



Fanless Touch Panel Computers

Heavy-duty Fanless Touch Panel Computers

Vehicle Mount Terminal Computer

Stainless Touch Panel Computers

Transportation Touch Panel Computers and Displays

Industrial Touch Panel Computers

Industrial Touch Monitors

Medical Panel Computers

Open Frame Panel Computer

# Industrial Panel PCs



# 8

## Medical Panel Computers

The MPC products are specifically designed for medical image processing and medical measuring instruments. The MPC product line complies with EN 60601-1, CE, and FCC Class B certifications to ensure operational safety in the medical industry. Featuring IP65-rated front bezels and IPX1-rated enclosures, the MPC series is water and dustproof, which ensures reliable operation when used in spill-prone and high dust environments.

Selection Guide		331
MPC103-845	10.1" WXGA TFT Fanless Medical Grade Touch Panel Computer with Intel® Celeron® Processor N3060	333
MPC102-845	10.4" XGA TFT Fanless Medical Grade Touch Panel Computer with Intel® Celeron® Processor N3060	335
MPC152-845	15" XGA TFT Fanless Medical Grade Touch Panel Computer with Intel® Celeron® Processor N3060	337
MPC153-834	15.6" WXGA TFT Fanless Medical Grade Touch Panel Computer with Intel® Celeron® Processor J1900	339
MPC240	24" FHD TFT Medical Grade Panel Computer with 4th Gen Intel® Core™ i7/i5/i3, Celeron® & Pentium® Mobile Processor	341

# Medical Panel Computers

## Selection Guide



Features/Models	MPC103-845	MPC102-845	MPC152-845
<b>CPU Level</b>	Intel® Celeron® N3060 (up to 2.48 GHz)	Intel® Celeron® N3060 (up to 2.48 GHz)	Intel® Celeron® N3060 (up to 2.48 GHz)
<b>Chipset</b>	SoC integrated	SoC integrated	SoC integrated
<b>System Memory</b>	1 x 204-pin DDR3L-1600 SO-DIMM, up to 8GB	1 x 204-pin DDR3L-1600 SO-DIMM, up to 8GB	1 x 204-pin DDR3L-1600 SO-DIMM, up to 8GB
<b>Display</b>	10.1" WXGA TFT, 350 nits	10.4" SVGA TFT, 350 nits	15" XGA TFT, 420 nits
<b>I/O</b>	1 x RS-232 1 x RS-232/422/485 2 x 10/100/1000 Mbps Ethernet 2 x USB 2.0 2 x USB 3.0 1 x Audio (Line-out) 1 x Switch for power on/off 1 x AT/ATX selectable switch	1 x RS-232 1 x RS-232/422/485 2 x 10/100/1000 Mbps Ethernet 2 x USB 2.0 2 x USB 3.0 1 x Audio (Line-out) 1 x Switch for power on/off 1 x AT/ATX selectable switch	1 x RS-232 1 x RS-232/422/485 2 x 10/100/1000 Mbps Ethernet 2 x USB 2.0 2 x USB 3.0 1 x Audio (Line-out) 1 x Switch for power on/off 1 x AT/ATX selectable switch 1 x 8-bit DIO (programmable, DB9)
<b>Storage</b>	1 x 2.5" half slim SSD (AC type only) 1 x mSATA	1 x 2.5" HDD 1 x mSATA	1 x 2.5" HDD 1 x mSATA
<b>DVD-RW</b>	N/A	N/A	N/A
<b>Expansion Interface</b>	2 x PCI Express Mini Card slot	2 x PCI Express Mini Card slot	2 x PCI Express Mini Card slot
<b>Touchscreen</b>	Projected capacitive multi-touch	5-wire Resistive Type	5-wire Resistive Type
<b>Power Supply</b>	9 to 36 VDC 100 to 240V, 65W (medical grade power adapter)	9 to 36 VDC 100 to 240V, 65W (medical grade power adapter)	9 to 36 VDC 100 to 240V, 65W (medical grade power adapter)
<b>Watchdog Timer</b>	255 levels, 0 to 255 sec.	255 levels, 0 to 255 sec.	255 levels, 0 to 255 sec.
<b>Dimensions (W x D x H)</b>	260.8 x 38 x 194.1 mm (10.27" x 1.5" x 7.65")	292.5 x 45.8 x 235.8 mm (1.52" x 1.8" x 9.28")	387.9 x 54.6 x 307.7 mm (15.27" x 2.14" x 12.11")
<b>Weight (net/gross)</b>	1.08 kg (2.38 lb)/2.18 kg (4.8 lb)	1.8 kg (3.96 lb)/3 kg (6.61 lb)	3.2 kg (7.05 lb)/5.1 kg (11.24 lb)
<b>Operating Temperature</b>	0° to +40°C (+32°F to +104°F)	0° to +40°C (+32°F to +104°F)	0° to +40°C (+32°F to +104°F)
<b>Certifications</b>	CE, EN 60601-1	CE, EN 60601-1	CE, EN 60601-1



Features/Models	MPC153-834	MPC240
<b>CPU Level</b>	Intel® Celeron® J1900 (up to 2.42 GHz)	Socket G3 4th gen Intel® Core™ i7/i5/i3 & Celeron®, Pentium® mobile
<b>Chipset</b>	SoC integrated	Intel® HM86
<b>System Memory</b>	1 x 204-pin DDR3L-1066/1333 SO-DIMM, up to 8GB	2 x 204-pin DDR3L-1600 SO-DIMM, up to 16GB
<b>Display</b>	15.6" WXGA TFT, 300 nits	24" FHD TFT, 250 nits
<b>I/O</b>	2 x RS-232/422/485 1 x RS-232/422/485 (with isolated 4KV) 2 x 10/100/1000 Mbps Ethernet 2 x USB 3.0 1 x Audio (Line-out)	4 x USB 3.0 4 x USB 2.0 1 x Audio (Line-out) 1 x Audio (Mic-in) 1 x 10/100/1000 Mbps Ethernet 1 x DC-in jack 1 x HDMI
<b>Storage</b>	1 x Half-slim SSD 1 x CFast™ or mSATA	1 x 2.5" SATA HDD 1 x M.2-2242 SATA SSD
<b>DVD-RW</b>	N/A	1 x Super multi drive (optional)
<b>Expansion Interface</b>	2 x PCI Express Mini Card slot	1 x PCI Express Mini Card slot
<b>Touchscreen</b>	Projected capacitive multi-touch 5-wire flat resistive type	Projected capacitive multi-touch
<b>Power Supply</b>	9 to 36 VDC 100 to 240V, 65W (medical grade power adapter)	100 to 240V, 135W (medical grade power adapter)
<b>Watchdog Timer</b>	255 levels, 0 to 255 sec.	255 levels, 0 to 255 sec.
<b>Dimensions (W x D x H)</b>	394.2 x 57 x 257.2 mm (15.53" x 2.25" x 10.13")	610 x 35.5 x 415 mm (24.01" x 1.40" x 16.34")
<b>Weight (net/gross)</b>	3.0 kg (6.61 lb)/4.5 kg (9.92 lb)	6.2 kg (13.66 lb)/9 kg (19.84 lb)
<b>Operating Temperature</b>	0°C to +40°C (+32°F to +104°F)	5°C to +40°C (+13°F to +104°F)
<b>Certifications</b>	CE, EN 60601-1, FCC classB	CE, EN 60601-1

1  
2  
3  
4  
5  
6  
7  
8  
9

Medical Panel Computers

# MPC103-845

10.1" WXGA TFT Fanless Medical Grade Touch Panel Computer with Intel® Celeron® Processor N3060

## Features

- 10.1" WXGA TFT LCD display with LED backlight
- Fanless design with Intel® Celeron® processor N3060
- 2 GbE LANs, 4 USB and 2 COM
- Plastic and IP65-rated front bezel
- Supports RFID (optional)
- External AT/ATX mode selection switch
- Easy access storage design
- Supports panel mount, wall mount, VESA arm and desktop stand
- Adjustable RS-232/422/485 setting via BIOS
- 4th EN 60601-1 (ESD contact 8KV, air 15KV), CE and FCC



▲ Side view



1. Power LED
2. HDD LED
3. Brightness adjust +/-
4. Display on/off
5. Volume adjust
6. Mic-in (optional)

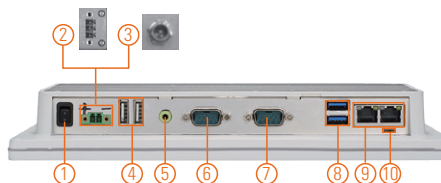

1. Power switch (ATX)
2. Terminal block for DC power input
3. Screw connector with AC power adapter
4. 2 x USB 2.0
5. Audio (Line-out)
6. 1 x RS-232/422/485
7. 1 x RS-232
8. 2 x USB 3.0
9. 2 x LAN
10. AT/ATX switch



## Introduction

The MPC103-845 is a 10.1" fanless medical touch panel computer. It adopts a modern, super sleek and fanless design and is equipped with a 10.1" TFT LCD as well as Intel® Celeron® processor N3060 dual core up to 2.48 GHz. For wireless network connection, the MPC103-845 offers 2 PCI Express Mini Card slots. By just plugging in the WLAN card, customers can have instant access to wireless LAN/GPRS/GSM/4G environments. Besides, it provides two types of power input: DC power with terminal block connector and AC power adapter with screw type connector.

### Super Slim & Ultra Lightweight Design

With a thickness of 38 mm and weight of 1.08 kg, the MPC103-845 is designed for use in space-constrained environments.

### Certifications

This 10.1-inch medical panel platform complies with 4th version of EN 60601-1 and CE, FCC Class B certifications to ensure medical operation safety.

### Aluminum Back Chassis with Excellent Thermal Solution

With Axiomtek's patent for plastic plus aluminum mechanism design, the MPC103-845 can dissipate the heat easily and keep the system operation stable.

## Specifications

Front Bezel	IP65, NEMA 4 rugged protection, plastic front bezel	
LCD Panel	Display Type	10.1" WXGA TFT LCD with LED backlight
	Brightness (cd/m <sup>2</sup> )	350 nits
	Resolution	1280 x 800
	Viewing Angel (H/V)	170°/170°
Main System	CPU	Intel® Celeron® processor N3060 2 cores (up to 2.48 GHz)
	System Memory	1 x 204-pin DDR3L-1600 SO-DIMM, up to 8GB
	BIOS	AMI UEFI BIOS
	Storage	1 x Half-slim SATA SSD (for MPC103-845-PCT-J, optional) 1 x mSATA
	Watchdog Timer	255 levels, 0 to 255 sec.
	Onboard Graphics	Integrated in Intel® GFX

## Specifications

I/O Connector	1 x RS-232 1 x RS-232/422/485 (default RS-232) 1 x Switch for power on/off 1 x AT/ATX mode selection switch 2 x USB 2.0 2 x USB 3.0 1 x Audio (Line-out) 2 x 10/100/1000 Mbps Ethernet (Intel® i211-AT)
Expansion Interface	1 x Full-size PCI Express Mini Card slot with mSATA 1 x Full-size PCI Express Mini Card slot with SIM
Touchscreen	Projected capacitive multi-touch
Power Supply	AC version: 100 to 240 VAC-DC, 65W power adapter or DC version: 9 to 36 VDC with over current protection fuse
Power Consumption	40.32 W
Dimension	387.9 mm (15.27") (W) x 54.6 mm (2.14") (D) x 307.7 mm (12.11") (H)
Packing Dimensions	510 mm (20.08") (W) x 105 mm (4.13") (D) x 385 mm (15.16") (H)
Weight (net/gross)	1.08 kg (2.38 lb)/2.18 kg (4.8 lb)
Operating Temperature	0°C to +40°C (+32°F to +122°F)
Relative Humidity	20% to 90% @ +40°C; non-condensing
Operation Vibration	2G, 5 - 500Hz, random for SSD
Certifications	4th EN 60601-1 (ESD contact 8KV, air 15KV), CE and FCC

## Packing List

1 x MPC103-845
1 x Driver CD
1 x Adapter (MPC103-845-J)
1 x Power cord (MPC103-845-J)
1 x Phoenix connector (MPC103-845 DC)

## Dimensions

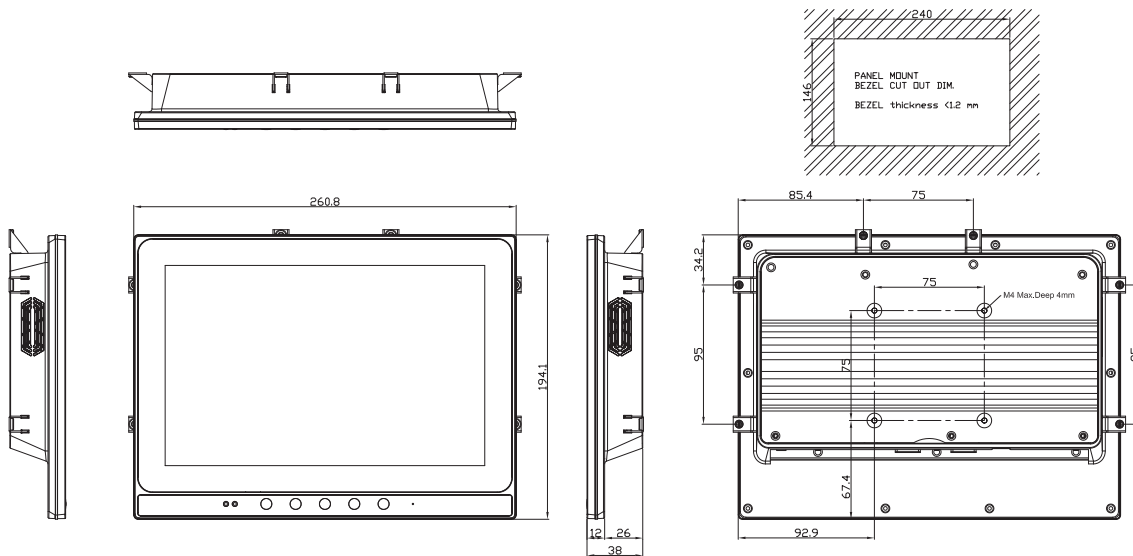

## Ordering Information

Standard	
MPC103-845-J	10.1" WXGA fanless medical touch panel computer with Intel® Celeron® processor N3060, projected capacitive touch screen, AC-DC 65W power adapter (screw type connector) and EMI class B
MPC103-845-DC	10.1" WXGA fanless medical touch panel computer with Intel® Celeron® processor N3060, projected capacitive touch screen and DC power input (terminal block connector)

## Optional Accessories

Wi-Fi + Bluetooth kit	
Half slim SATA SSD bracket kit	
82251030080E	GOT5103W-845 half slim SSD kit SFP for GOT5103W-845-PCT-J
881251030A0E	Panel mount kit
881238460A0E	Wall mount kit
881251203A0E	RFID kit
E226171119	Stand Kit

\*Specifications and certifications may vary based on different requirements.

## Optional EOS Installation

WES 7
WE8S (64-bit)

## Optional OS Installation

Windows® 7
Windows® 8.1 (64-bit)
Windows® 10



# MPC102-845

10.4" XGA TFT Fanless Medical Grade Touch Panel Computer with Intel® Celeron® Processor N3060

## Features

- 10.4" XGA TFT LCD display with LED backlight
- Fanless design with Intel® Celeron® processor N3060
- 2 GbE LANs, 4 USB and 2 COM
- Plastic and IP65-rated front bezel
- Supports RFID (optional)
- External AT/ATX mode selection switch
- Easy access storage design
- Supports panel mount, wall mount, VESA arm and desktop stand
- 4th EN 60601-1 (ESD contact 8KV, air 15KV), CE and FCC certified



▲ Side view

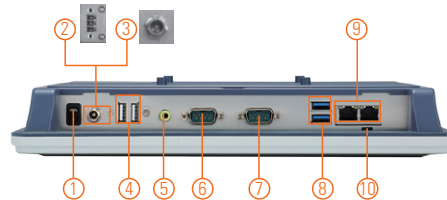

- |                                    |                              |
|------------------------------------|------------------------------|
| 1. Power switch (ATX)              | 6. 1 x RS-232/422/485        |
| 2. Power input connector (Screw)   | 7. 1 x RS-232                |
| 3. Power input connector (Phoenix) | 8. 2 x USB 3.0               |
| 4. 2 x USB 2.0                     | 9. 2 x LAN                   |
| 5. Audio (Line-out)                | 10. AT/ATX selectable switch |
|                                    | 11. Touch on/off button      |



## Introduction

The MPC102-845 is a 10.4" fanless medical touch panel computer. In response to market demand, this medical panel computer is a cost effective solution. It adopts a modern, super sleek and fanless design and is equipped with the Intel® Celeron® processor N3060 dual core up to 2.48 GHz. For wireless network connection, the MPC102-845 offers 2 PCI Express Mini Card slots. By just plugging in the WLAN card, customers can have instant access to wireless LAN/GPRS/GSM/4G environments. Besides, it provides two types of power input: DC power with terminal block connector and AC power adapter with screw type connector.

### Super Slim & Ultra Lightweight Design

With a thickness of 45.8 mm and weight of 1.8 kg, the MPC102-845 is designed for use in space-constrained environments.

### Certifications

This 10.4-inch medical panel platform complies with 4th version of EN 60601-1 and CE, FCC Class B certifications to ensure medical operation safety.

### Aluminum Back Chassis with Excellent Thermal Solution

With Axiomtek's patent for plastic plus aluminum mechanism design, the MPC102-845 can dissipate the heat easily and keep the system operation stable.

## Specifications

Front Bezel	IP65, NEMA 4 rugged protection, plastic front bezel	
LCD Panel	Display Type	10.4" XGA TFT LCD with LED backlight
	Brightness (cd/m <sup>2</sup> )	350 nits (XGA)
	Resolution	1024 x 768 (XGA)
	Viewing Angel (H/V)	150°/150°
Main System	CPU	Intel® Celeron® processor N3060 2 cores (up to 2.48 GHz)
	System Memory	1 x 204-pin DDR3L-1600 SO-DIMM, up to 8GB
	BIOS	AMI UEFI BIOS
	Storage	1 x 2.5" SATA HDD (9.5 mm height) 1 x mSATA
	Watchdog Timer	255 levels, 0 to 255 sec.
	Onboard Graphics	Integrated in Intel® GFX



## Specifications

I/O Connector	1 x RS-232 1 x RS-232/422/485 (default RS-232) 1 x Switch for power on/off 1 x AT/ATX mode selection switch 2 x USB 2.0 2 x USB 3.0 1 x Audio (Line-out) 2 x 10/100/1000 Mbps Ethernet (Intel® i211-AT)
Expansion Interface	1 x Full-size PCI Express Mini Card slot with mSATA 1 x Full-size PCI Express Mini Card slot with SIM
Touchscreen	Resistive type
Power Supply	AC version: 100 to 240 V AC-DC, 65W power adapter or DC version: 9 to 36 VDC with over current protection fuse
Power Consumption	32W
Dimension	292.5 mm (11.52") (W) x 45.8 mm (1.80") (D) x 235.8 mm (9.28") (H)
Packing Dimensions	415 mm (16.34") (W) x 100 mm (3.94") (D) x 315 mm (12.4") (H)
Weight (net/gross)	1.8 kg (3.96 lb)/3 kg (6.61 lb)
Operating Temperature	0°C to +40°C (+32°F to +122°F)
Relative Humidity	20% to 90% @ +40°C; non-condensing
Operation Vibration	2G, 5 - 500Hz, random for SSD
Certifications	4th EN 60601-1 (ESD contact 8KV, air 15KV), CE and FCC

## Packing List

- 1 x MPC102-845
- 1 x Driver CD
- 1 x Adapter (MPC102-845-J)
- 1 x Power cord (MPC102-845-J)
- 1 x Phoenix connector (MPC102-845 DC)

## Ordering Information

Standard	
MPC102-845-J	10.4" XGA fanless medical touch panel computer with Intel® Celeron® processor N3060, 5-wire resistive touch screen, AC-DC 65W power adapter (screw type connector) and EMI class B
MPC102-845-DC	10.4" XGA fanless medical touch panel computer with Intel® Celeron® processor N3060, 5-wire resistive touch screen and DC power input (terminal block connector)

## Optional Accessories

Wi-Fi + Bluetooth kit	
881281021A0E	Panel mount kit
881251001A0E	Wall mount kit
E226171119	Stand kit
881251203A0E	RFID kit

\*Specifications and certifications may vary based on different requirements.

## Optional EOS Installation

WES 7
WE8S (64-bit)

## Optional OS Installation

Windows® 7
Windows® 8.1 (64-bit)
Windows® 10



▲ AC power adapter (for MPC102-845-J)

## Dimensions

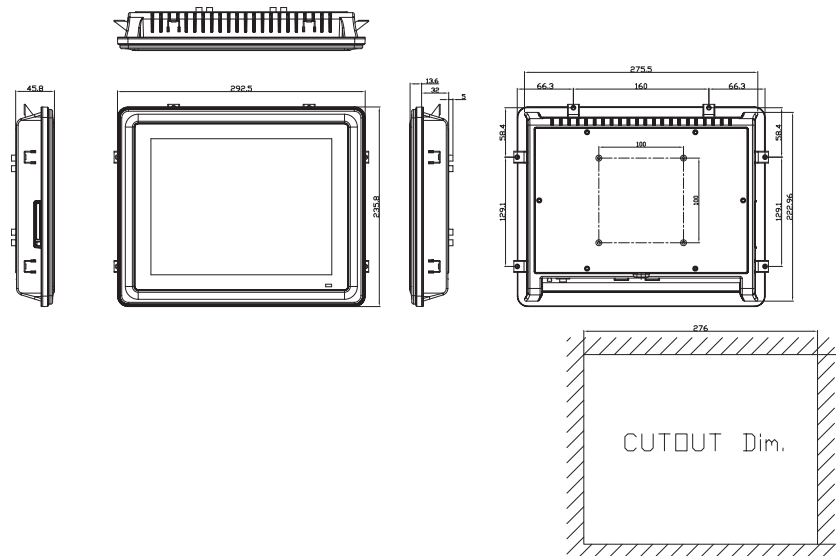

# MPC152-845

15" XGA TFT Fanless Medical Grade Touch Panel Computer with Intel® Celeron® Processor N3060

## Features

- 15" XGA TFT LCD display with LED backlight
- Fanless design with Intel® Celeron® processor N3060
- 2 GbE LANs, 4 USB and 2 COM
- Plastic and IP65-rated front bezel
- Supports RFID (optional)
- External AT/ATX mode selection switch
- Easy access storage design
- Supports panel mount, wall mount, VESA arm and desktop stand
- Adjustable RS-232/422/485 setting via BIOS
- 4th EN 60601-1 (ESD contact 8KV, air 15KV), CE and FCC



▲ Side view

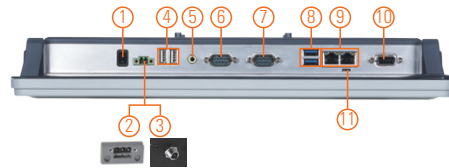

- |                                    |                                 |
|------------------------------------|---------------------------------|
| 1. Power switch (ATX)              | 8. 2 x USB 3.0                  |
| 2. Power input connector (Phoenix) | 9. 2 x LAN                      |
| 3. Power input connector (Screw)   | 10. 8 x DIO (programmable, DB9) |
| 4. 2 x USB 2.0                     | 11. AT/ATX selectable switch    |
| 5. Audio (Line-out)                | 12. Touch LED indicator         |
| 6. 1 x RS-232/422/485              | 13. Touch on/off button         |
| 7. 1 x RS-232                      | 14. HDD & Power LED indicator   |



## Introduction

The MPC152-845 is a 15" fanless medical touch panel computer. In response to market demand, this medical panel computer is a cost effective solution. It adopts a modern, super sleek and fanless design and is equipped with a 15" TFT LCD as well as Intel® Celeron® processor N3060 dual core up to 2.48 GHz. For wireless network connection, the MPC152-845 offers 2 PCI Express Mini Card slots. By just plugging in the mini card WLAN card, customers can have instant access to wireless LAN/GPRS/GSM/4G environments. Besides, it provides two types of power input: DC power with terminal block connector and AC power adapter with screw type connector.

### Super Slim & Ultra Lightweight Design

With a thickness of 54.6 mm and weight of 3.2 kg, the MPC152-845 is designed for use in space-constrained environments.

### Certifications

This 15-inch medical panel platform complies with 4th version of EN 60601-1 and CE, FCC Class B certifications to ensure medical operation safety.

### Aluminum Back Chassis with Excellent Thermal Solution

With Axiomtek's patent for plastic plus aluminum mechanism design, the MPC152-845 can dissipate the heat easily and keep the system operation stable.

## Specifications

Front Bezel	IP65, NEMA 4 rugged protection, plastic front bezel	
LCD Panel	Display Type	15" XGA TFT LCD with LED backlight
	Brightness (cd/m <sup>2</sup> )	420 nits (XGA)
	Resolution	1024 x 768 (XGA)
	Viewing Angel (H/V)	160°/160°
Main System	CPU	Intel® Celeron® processor N3060 2 cores (up to 2.48 GHz)
	System Memory	1 x 204-pin DDR3L-1600 SO-DIMM, up to 8GB
	BIOS	AMI UEFI BIOS
	Storage	1 x 2.5" SATA HDD (9.5 mm height)
		1 x mSATA
	Watchdog Timer	255 levels, 0 to 255 sec.
	Onboard Graphics	Integrated in Intel® GFX

## Specifications

I/O Connector	1 x RS-232 1 x RS-232/422/485 2 x 10/100/1000 Mbps Ethernet 2 x USB 2.0 2 x USB 3.0 1 x Audio (Line-out) 1 x Switch for power on/off 1 x AT/ATX selectable switch 1 x 8-bit DIO (programmable, DB9)
Expansion Interface	1 x Full-size PCI Express Mini Card slot with mSATA 1 x Full-size PCI Express Mini Card slot with SIM
Touchscreen	Resistive type
Power Supply	AC version: 100 to 240 V AC-DC, 65W power adapter or DC version: 9 to 36 VDC with over current protection fuse
Power Consumption	32 W
Dimension	387.9 mm (15.27") (W) x 54.6 mm (2.14") (D) x 307.7 mm (12.11") (H)
Packing Dimensions	510 mm (20.08") (W) x 105 mm (4.13") (D) x 385 mm (15.16") (H)
Weight (net/gross)	3.2 kg (7.05 lb)/5.1 kg (11.24 lb)
Operating Temperature	0°C to +40°C (+32°F to +122°F)
Relative Humidity	20% to 90% @ +40°C; non-condensing
Operation Vibration	2G, 5 - 500Hz, random for SSD
Certifications	4th EN 60601-1 (ESD contact 8KV, air 15KV), CE and FCC

## Packing List

- 1 x MPC152-845
- 1 x Driver CD
- 1 x Adapter (MPC152-845-J)
- 1 x Power cord (MPC152-845-J)
- 1 x Phoenix connector (MPC152-845 DC)

## Dimensions

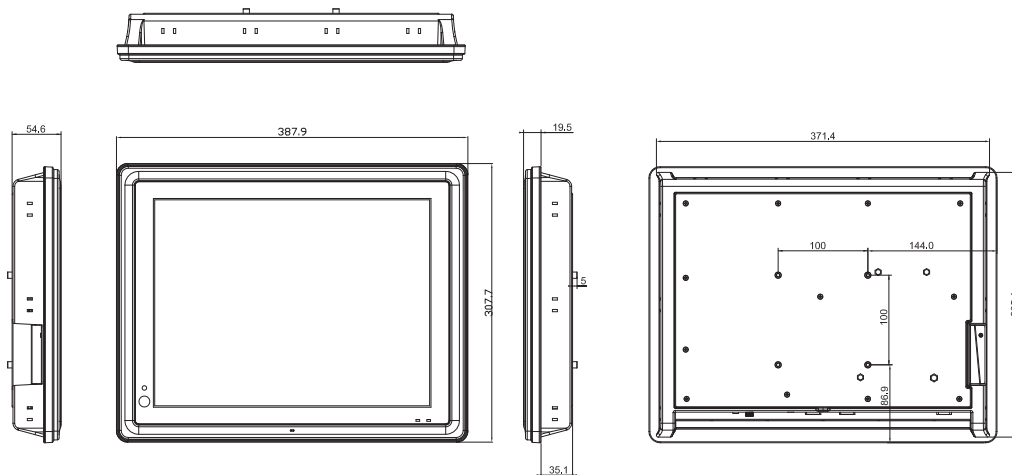

## Ordering Information

Standard	
MPC152-845-J	15" XGA fanless medical touch panel computer with Intel® Celeron® processor N3060, 5-wire resistive touch screen, AC-DC 65W power adapter (screw type connector) and EMI class B
MPC152-845-DC	15" XGA fanless medical touch panel computer with Intel® Celeron® processor N3060, 5-wire resistive touch screen and DC power input (terminal block connector)

## Optional Accessories

Wi-Fi + Bluetooth kit	
881251520A0E	Panel mount kit
881251521A0E	Wall mount kit
E226171119	Stand kit
881251203A0E	RFID kit

\*Specifications and certifications may vary based on different requirements.

## Optional EOS Installation

WES 7
WE8S (64-bit)

## Optional OS Installation

Windows® 7
Windows® 8.1 (64-bit)
Windows® 10



# MPC153-834

15.6" WXGA TFT Fanless Medical Grade Touch Panel Computer with Intel® Celeron® Processor J1900

## Features

- 15.6" WXGA TFT LCD display with LED backlight
- Projected capacitive touch or 5-wire flat resistive touch for optional
- Fanless design with Intel® Celeron® processor J1900 4 cores (up to 2.42 GHz)
- EN 60601-1/CE/FCC class B certified
- Half-slim SSD & CFast™ or mSATA
- Antimicrobial plastic enclosure
- IP65 front bezel and IPX1 full enclosure design
- Supports wall mount, VESA arm and desktop stand
- Supports smart card reader (optional)

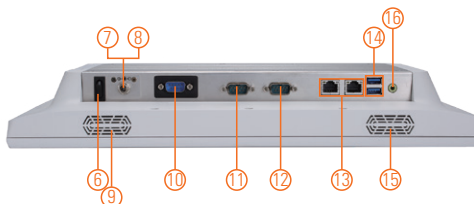

- |                          |                                    |                      |
|--------------------------|------------------------------------|----------------------|
| 1. Power LED             | 7. Power input connector (Screw)   | 13. 2 x LAN          |
| 2. HDD LED               | 8. Power input connector (Phoenix) | 14. 2 x USB 3.0      |
| 3. Brightness adjust +/- | 9. Speaker                         | 15. Speaker          |
| 4. Display on/off        | 10. Isolated COM                   | 16. Audio (Line-out) |
| 5. Volume adjust         | 11. 1 x RS-232/422/485             |                      |
| 6. Power switch (ATX)    | 12. 1 x RS-232/422/485             |                      |



## Introduction

The MPC153-834 is a 15.6" fanless medical grade touch panel computer. In response to market demand, this medical touch panel computer is a cost effective solution. It adopts a modern, sleek and fanless design and is equipped with the Intel® Celeron® processor J1900 4 cores up to 2.42 GHz (Bay Trail). For wireless network connection, the MPC153-834 offers 2 PCI Express Mini Card slots. By just plugging in a WLAN card, customers can have instant access to wireless LAN/GPRS/GSM/4G environments. Besides, it provides two types of power input: DC power input (9 to 36VDC) with terminal block connector and AC medical power adapter with screw type connector.

### Slim & Lightweight Design

The 15.6-inch medical panel PC is slim and lightweight, perfect for limited space installation.

### Built-in Internal WLAN Antenna

The MPC153-834 provides 2 PCI Express Mini Card slots and a built-in WLAN antenna for wireless network connections. By simply plugging in the wireless LAN card, customers can use the medical computer in wireless LAN/GPRS/GPS/4G environment.

### Support Front Membrane Keys

The MPC153-834 has 5 membrane keys on the front panel which allows users to adjust the LCD on/off, LCD brightness and volume setting easily.

### Certifications

This 15.6-inch fanless medical panel platform complies with EN 60601-1, CE, FCC Class B certifications to ensure medical operation safety.

## Specifications

Front Bezel	IP65 front bezel	
LCD Panel	Display Type	15.6" WXGA TFT LCD display with LED backlight
	Brightness (cd/m <sup>2</sup> )	300 nits
	Resolution	1366 x 768
Main System	CPU	Intel® Celeron® processor J1900 4 cores
	System Memory	1 x 204-pin DDR3L-1066/1333 SO-DIMM, up to 8GB
	BIOS	AMI UEFI BIOS
	Storage	1 x Half-slim SSD 1 x CFast™ or mSATA
	Watchdog Timer	255 levels, 0 to 255 sec.
	Onboard Graphics	Integrated Intel® GFX

## Specifications

I/O Connector	2 x RS-232/422/485 (default RS-232) 1 x RS-232 with isolated 4KV 2 x 10/100/1000 Mbps Ethernet (Intel® i210-IT) 2 x USB 3.0 1 x Audio (Line-out)
Expansion Interface	1 x Full-size PCI Express Mini Card with mSATA 1 x Full-size PCI Express Mini Card with SIM
Touchscreen	Projected capacitive multi-touch or 5-wire flat resistive touch
Power Supply	AC version: medical grade 100 to 240 V AC-DC, 60W power adapter DC version: 9 to 36 VDC with terminal block
Dimensions	394.2 mm (15.53") (W) x 57 mm (2.25") (D) x 257.2 mm (10.13") (H)
Packing Dimensions	510 mm (20.09") x 190 mm (7.48") x 540 mm (21.26")
Weight (net/gross)	3.0 kg (6.61 lb)/4.5 kg (9.92 lb)
Operating Temperature	0°C to +40°C (32°F to +104°F, with RAM thermal kit)
Relative Humidity	20% to 90% @ +40°C; non-condensing
Operation Vibration	2G, 10 - 500Hz, random for CFast™
Certifications	CE, FCC class B and EN60601-1

\* W.T.: Wide Temperature. All W.T. supported products have to be sorted by Axiomtek.

\* The DC power source to be used with MPC153-834 must be galvanically isolated according to IEC60601-1 safety of medical devices!

## Packing List

- 1 x MPC153-834
- 1 x Driver CD
- 1 x Adapter (MPC153-834-J)
- 1 x Power cord (MPC153-834-J)
- 1 x Phoenix connector (MPC153-834 DC)

## Dimensions

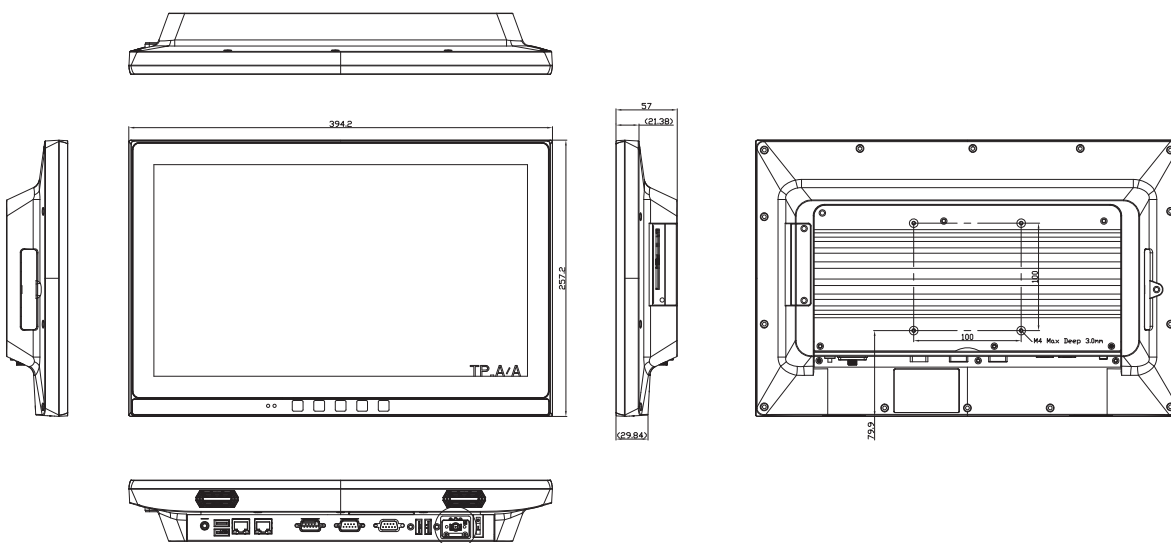

Phoenix plug For DC version



Din-jack For AC version

## Ordering Information

Standard	
MPC153-834-PCT-J	15.6" WXGA fanless medical touch panel computer with Intel® Celeron® processor J1900, projected capacitive multi-touch screen, AC-DC 60 W power adapter (screw type connector), EMI class B and EN 60601-1 certified
MPC153-834-FR-J	15.6" WXGA fanless medical touch panel computer with Intel® Celeron® processor J1900, 5-wire flat resistive touch screen, AC-DC 60 W power adapter (screw type connector), EMI class B and EN 60601-1 certified
MPC153-834-PCT-DC	15.6" WXGA fanless medical touch panel computer with Intel® Celeron® processor J1900, projected capacitive multi-touch screen, 10 to 30 VDC power input (terminal block connector) and EN 60601-1 certified
MPC153-834-FR-DC	15.6" WXGA fanless medical touch panel computer with Intel® Celeron® processor J1900, 5-wire flat resistive touch screen, 10 to 30 VDC power input (terminal block connector) and EN 60601-1 certified

## Optional Accessories

Wi-Fi + Bluetooth kit

Smart card reader kit

\*Specifications and certifications may vary based on different requirements.

## Optional EOS Installation

WES7

WE8S

## Optional OS Installation

Windows® 7

Windows® 8.1

1

2

3

4

5

6

7

8

9

# MPC240

24" FHD TFT Medical Grade Panel Computer with 4th Gen Intel® Core™ i7/i5/i3, Celeron® & Pentium® Mobile Processor

## Features

- 24" FHD TFT LCD display with LED backlight
- Socket G3 4th gen Intel® Core™ i7/i5/i3, Celeron® & Pentium® mobile processors
- EN 60601-1 and CE certified
- Spill-proof front panel design
- 10-point multi-touch screen
- Antimicrobial enclosure
- Ultra slim and super lightweight design
- Supports wall mount, VESA arm and desktop stand

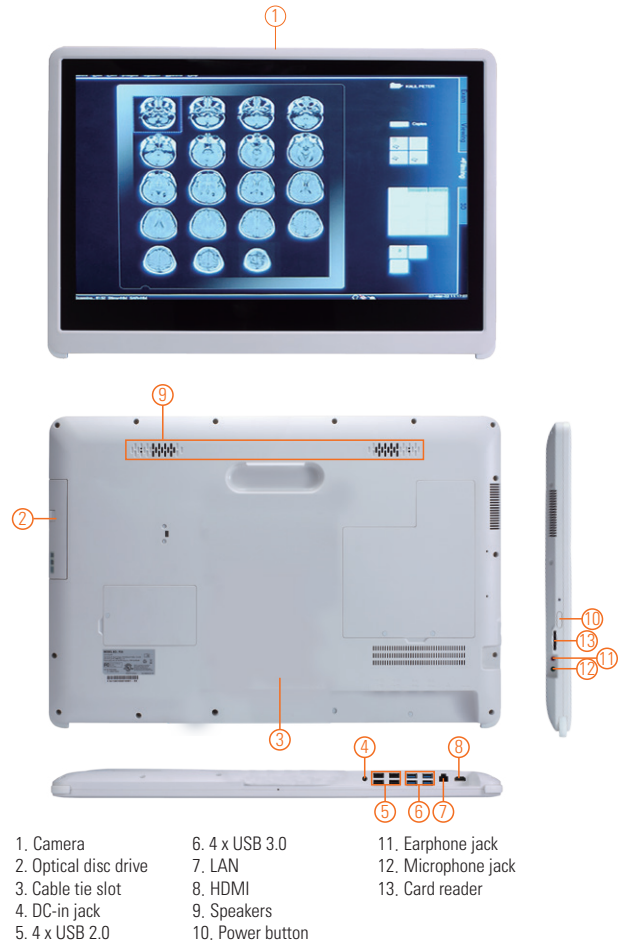

- |                       |                  |                     |
|-----------------------|------------------|---------------------|
| 1. Camera             | 6. 4 x USB 3.0   | 11. Earphone jack   |
| 2. Optical disc drive | 7. LAN           | 12. Microphone jack |
| 3. Cable tie slot     | 8. HDMI          | 13. Card reader     |
| 4. DC-in jack         | 9. Speakers      |                     |
| 5. 4 x USB 2.0        | 10. Power button |                     |



## Introduction

The MPC240 is an 24-inch medical grade touch panel computer which is designed for applications like medical image processing and medical measuring instrument. Especially designed for the medical & healthcare environment, the 10-point touchscreen medical panel PC has spill-proof front panel design which protects the entire system from outside liquid, preventing system from crashing.

### Super Slim & Ultra Lightweight Design

With a thickness of 35.5 mm and weight of 6.2 kg, the MPC240 is designed for use in space-constrained environments. Besides, it provides medical grade AC power adapter.

### Built-in Internal WLAN

The stylish MPC240 provides a PCI Express Mini Card slot and a built-in WLAN antenna for wireless network connections. By simply plugging in the wireless LAN card, customers can use the 24-inch medical computer in a wireless LAN/GPRS/GSM/4G environment.

### Certifications

This 24" multi-touch medical panel platform complies with EN 60601 and CE to ensure medical operation safety.

## Specifications

Front Bezel		Spill-proof
LCD Panel	Display Type	24" FHD TFT LCD with LED backlight
	Brightness (cd/m <sup>2</sup> )	250 nits
	Resolution	1920 x 1080
Main System	CPU	Socket G3 4th gen Intel® Core™ i7/i5/i3 & Celeron®, Pentium® mobile processors
	System Memory	2 x 204-pin DDR3L-1600 SO-DIMM, up to 16GB, 8GB for each socket
	BIOS	AMI BIOS
	Storage	1 x 2.5" SATA HDD (9.5 mm height) 1 x M.2-2242 SATA SSD
	Optical Drive	1 x Super multi-drive (optional)
	Watchdog Timer	255 levels, 0 to 255 sec.
	Onboard Graphics	Integrated in Intel® GFX



## Specifications

I/O Connector	4 x USB 3.0 4 x USB 2.0 1 x Audio (Line-out & Mic-in) 1 x 10/100/1000 Mbps Ethernet 1 x DC-in jack 1 x HDMI
Expansion Interface	1 x SDXC card reader slot 1 x PCI Express Mini Card slot for Wi-Fi
Audio	2 x 1.5 KHz speaker/70dB 1 x Microphone
Camera	1 x 2M pixels webcam
Sensor	1 x Proximity sensor
Touch Screen	Projected capacitive multi-touch 10-point
Power Supply	100 to 240 V, 135 W medical grade power adapter Built-in UPS battery (optional)
Dimensions	610 mm (24.01") (W) x 35.5 mm (1.40") (D) x 415 mm (16.34") (H)
Packing Dimensions	780 mm (30.71") (W) x 160 mm (6.30") (D) x 530 mm (20.87") (H)
Weight(net/gross)	6.2 kg (13.66 lb)/9 kg (19.84 lb)
Operating Temperature	+5°C to +40°C (+13°F to +104°F)
Relative Humidity	10% to 90% @ +40°C; non-condensing
Certifications	CE, EN 60601-1

## Packing List

1 x MPC240  
1 x Driver CD  
1 x Adapter  
1 x EU power cord

## Ordering Information

Standard	
MPC240	24" FHD medical touch panel computer with Intel® Core™ processor, projected capacitive multi-touch screen, AC-DC 135 W medical grade power adapter (screw type connector), EMI class B and EN 60601-1 certified

## Optional Accessories

Wi-Fi + Bluetooth kit

\*Specifications and certifications may vary based on different requirements.

## Optional OS Installation

Windows® 7

Windows® 8.1

## Dimensions

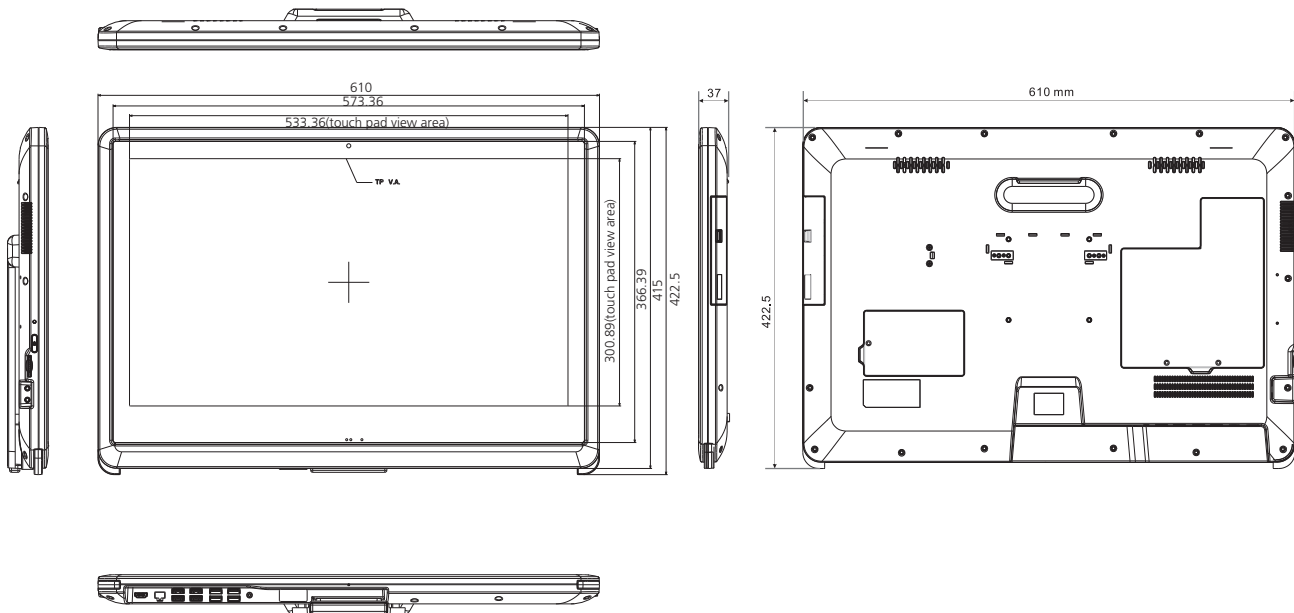

# 9

## Open Frame Panel Computer

Axiomtek's FDK series is an open frame LCD panel computer with outstanding configuration flexibility to help system integrators with configuring kiosk PCs. To easily fit into any space or to be encased into any chassis, the FDK series comes with open frame and slim design. For versatile applications, several touchscreen options are available to offer different viewer experiences. The FDK series can be widely deployed for indoor kiosk, HMI automation, and much more applications.

Selection Guide		344
FDK172-834	17" SXGA TFT Open Frame Panel Computer with Intel® Celeron® Processor J1900	345

# Industrial Panel PCs

# Open Frame Panel Computer

## Selection Guide



Features/Models	FDK172-834
<b>CPU Level</b>	Intel® Celeron® J1900 2.0 GHz
<b>LCD Panel</b>	17" SXGA TFT LCD 250 nits 1280 x 1024
<b>Chipset</b>	SoC integrated
<b>System Memory</b>	1 x 204-pin DDR3L-1333 SO-DIMM, up to 8GB
<b>CPU FSB Frequency</b>	N/A
<b>I/O</b>	4 x RS-232/422/485 2 x USB 3.0 2 x USB 2.0 1 x 10/100/1000 Mbps Ethernet 1 x Audio (Line-out) 1 x VGA
<b>Storage</b>	1 x 2.5" SATA HDD 1 x CFast™ or mSATA
<b>FDD</b>	N/A
<b>CD-ROM</b>	N/A
<b>Expansion</b>	2 x PCI Express Mini Card slot
<b>Touchscreen</b>	5-wire resistive type (optional)
<b>Operating System</b>	Windows® 8.1, WEBS, Windows® 7, WES 7
<b>Power Supply</b>	9 to 36 VDC
<b>Power Consumption</b>	57.60W
<b>Watchdog Timer</b>	255 levels, 0 to 255 sec.
<b>Dimensions (W x D x H)</b>	367 x 65 x 304.5 mm (14.45" x 2.6" x 11.99")
<b>Weight (net/gross)</b>	5.52 kg (12.16 lb)/7.5 kg (16.53 lb)
<b>Operating Temperature</b>	0°C to +50°C (+32°F to +122°F)
<b>Certifications</b>	CE

1

2

3

4

5

6

7

8

9

Open  
Frame Panel  
Computer

# FDK172-834

17" SXGA TFT Open Frame Panel Computer with Intel® Celeron® Processor J1900

## Features

- Front panel open frame design
- Outstanding configuration flexibility delivering best ROI
- 17" SXGA TFT LCD display
- Intel® Celeron® processor J1900 2.0 GHz (Bay Trail-D)
- Resistive touchscreen optional
- Supports VESA arm and open frame mount
- Two PCI Express Mini card slots
- RS-232/422/485 selectable via BIOS

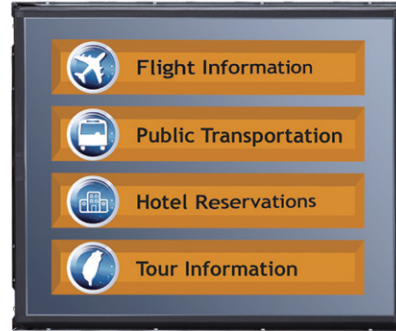

▲ Rear view

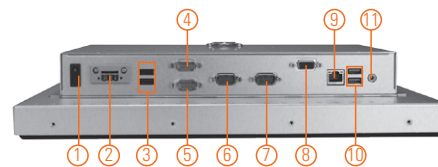

1. Power switch (ATX)
2. Terminal block for DC power input or screw connector with AC adapter
3. 2 x USB 2.0
4. RS-232/422/485
5. RS-232/422/485
6. RS-232/422/485
7. RS-232/422/485
8. 1 x VGA
9. 1 x LAN
10. 2 x USB 3.0
11. Audio (Line-out)

## Introduction

The FDK172-834 is an open frame panel computer with outstanding flexibility, configurable in a variety of ways to deliver best ROI for a variety of applications. It features Intel® Celeron® processor J1900 2.0 GHz with a 17" LCD display with up to 1280 x 1024 resolution, providing a very cost effective low power solution.

### Slim design

Designed to integrate into your custom enclosure, this 17-inch open frame unit offers an open frame slim design architecture for easy fit. The FDK172-834 is ideal for indoor kiosk, HMI, automation, signage and other applications. The system is only 65 mm deep and provides narrow bezel widths of 13-15 mm for space-saving custom bezels and enclosure applications.

### Touchscreen option

A resistive touchscreen option is available for interactive user interface requirements. Optionally, when ordered without touchscreen you get an even lower cost solution for dynamic signage or informational applications.

### RS-232/422/485 adjustment & PCIe Mini Card slot

It is user friendly to adjust RS-232/422/485 setting via BIOS instead of adjusting it via jumper. Dual PCI Express Mini Card slots are standard for I/O expansion such as Wi-Fi, 3G connection, or other 3rd party I/O cards.

## Specifications

LCD Panel	Display Type	17" SXGA TFT LCD
	Brightness (cd/m <sup>2</sup> )	250 nits
	Resolution	1280 x 1024
	Viewing Angle (H/V)	170°/160°
Main System	CPU	Intel® Celeron® processor J1900 4C@2.0 GHz
	Chipset	SoC integrated
	System Memory	1 x 204-pin DDR3L-1333/1600 SO-DIMM, up to 8GB
	BIOS	AMI UEFI BIOS
	Storage	1 x 2.5" SATA HDD (9.5 mm height) 1 x CFast™ or 1 x mSATA
	Watchdog Timer	255 levels, 0 to 255 sec.
	Onboard Graphics	Integrated Intel® GFX

## Specifications

I/O Connector	4 x RS-232/422/485 (default RS-232) 1 x 10/100/1000 Mbps Ethernet (Intel® i210-IT) 2 x USB 3.0 2 x USB 2.0 1 x Audio (Line-out) 1 x VGA
Expansion Interface	2 x PCI Express Mini Card slot
Touchscreen	Resistive type (optional)
Power Supply	DC version: 12 to 36 VDC with over-current protection fuse AC version: 100 to 240 VAC-DC 60W power adapter
Power Consumption	57.60W
Dimensions	367 mm (14.45") (W) x 65 mm (2.6") (D) x 304.5 mm (11.99") (H) (FDK172-834-N, without touch) 367 mm (14.45") (W) x 69.8 mm (2.74") (D) x 304.5 mm (11.99") (H) (FDK172-834-R, with touch)
Packing Dimensions	510 mm (20.08") (W) x 190 mm (7.48") (D) x 540 mm (21.26") (H)
Weight (net/gross)	5.52 kg (12.16 lb)/7.5 kg (16.53 lb)
Operating Temperature	0°C to +50°C (+32°F to +122°F)
Relative Humidity	10% to 90% @40°C, non-condensing
Certifications	CE

\* Specification and certifications are based on options and may vary.

\*\* W.T.: Wide Temperature. All W.T. supported products have to be sorted by Axiomtek.

## Packing List

1 x FDK172-834 DC
1 x Driver CD
1 x Phoenix connector (FDK172-834 DC)

## Ordering Information

FDK172-834-R-DC	17" SXGA open frame touch panel computer with Intel® Celeron® processor J1900, 5-wire resistive touch screen, and 12 to 36 VDC power input (terminal block connector)
FDK172-834-N-DC	17" SXGA open frame panel computer with Intel® Celeron® processor J1900 and 12 to 36 VDC power input (terminal block connector)

\* Specifications and certifications may vary based on different requirements.

## Optional OS Installation

WES7
WE8S
Windows® 8
Windows® 7



▲ Rear view



▲ Side view

## Dimensions

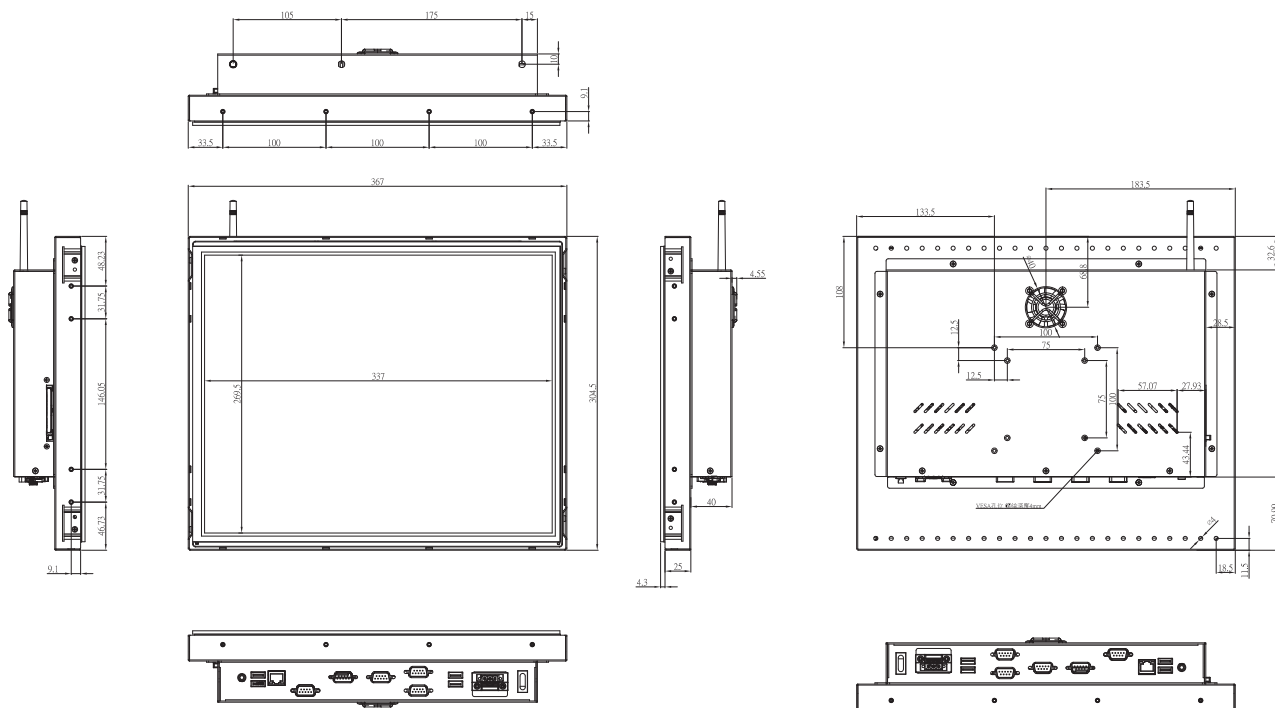





# Table of Contents

## Network Appliances



### 1 SOHO Network Appliances

---

Selection Guide		351
NA362	Desktop Network Appliance Platform with Intel® Atom® Processor C3338/C3558/C3758 and up to 10 LANs	352
NA361	Desktop Network Appliance Platform with Intel® Atom® Processor C2358 and 6 LANs	353
NA345	Desktop Network Appliance Platform with Intel® Pentium® Processor N4200/Celeron® Processor N3350 and 4 LANs	354
NA342	Desktop Network Appliance Platform with Intel® Celeron® Processor J1900 and 4 LANs	355

### 2 SMB Network Appliances



---

Selection Guide		357
<b>2U Network Appliances</b>		
NA860	2U Rackmount Network Appliance Platform with Dual LGA3647 Socket Intel® Skylake Server Processors, Intel® C621 (Purley) and up to 66 LANs	359
NA850	2U Rackmount Network Appliance Platform with Dual LGA2011 Socket Intel® Xeon® E5-2600 v3/v4 Family Processors, Intel® C612 and up to 42 LANs	360
<b>1U Network Appliances</b>		
 NA861	1U Rackmount Network Appliance Platform with LGA3647 Socket Intel® Skylake Server Processor, Intel® C621 (Purley) and up to 34 LANs	361
 NA590	1U Rackmount Network Appliance Platform with LGA1151 Socket Intel® Core™/Xeon® E-2100 Series Processor, Intel® C246/H310 and up to 26 LANs	362
NA580	1U Rackmount Network Appliance Platform with LGA1151 Socket Intel® Xeon® E3/Core™ Processor and 8 LANs	363
NA362R	1U Rackmount Network Appliance Platform with Intel® Atom® Processor C3558/C3758 and up to 10 LANs	364

# 3 Edge Server Platforms

---

Selection Guide 367

-  iSvr560 2U Compact Edge Server Platform with Intel® Xeon® Processor and 24-port GbE Managed Switch 368
-  iSvr660 2U Slim Edge Server Platform with Intel® Dual Purley Scalable Processor and 24-port GbE Managed Switch 369

# 1

## SOHO Network Appliances

Axiomtek's SOHO (Small Office and Home Office) network appliance platforms with compact size design, fantastic enclosure management capability, strict electromagnetic compatibility for class B, energy saving and multiple Ethernet ports, are suitable for various environments and applications in space-limited environments. Axiomtek's SOHO series provides not only reasonable performance and reliable hardware platforms, but also system development kits for software integration.

Selection Guide		351
NA362	Desktop Network Appliance Platform with Intel® Atom® Processor C3338/C3558/C3758 and up to 10 LANs	352
NA361	Desktop Network Appliance Platform with Intel® Atom® Processor C2358 and 6 LANs	353
NA345	Desktop Network Appliance Platform with Intel® Pentium® Processor N4200/Celeron® Processor N3350 and 4 LANs	354
NA342	Desktop Network Appliance Platform with Intel® Celeron® Processor J1900 and 4 LANs	355

## Network Appliances

# SOHO Network Appliances

## Selection Guide



Features \ Models	NA362	NA361	NA345	NA342	
<b>Form Factor</b>	1U desktop	1U desktop	1U desktop	1U desktop	
<b>Processor</b>	Intel® Atom® C3000	Intel® Atom® C2358 (2-Core) (NA361FL by request)	Intel® Pentium® N4200 (4-Core) Intel® Celeron® N3350 (2-Core)	Intel® Celeron® J1900 (4-core)	
<b>Chipset</b>	SoC integrated	SoC integrated	SoC integrated	SoC integrated	
<b>BIOS</b>	AMI SPI Flash BIOS	AMI SPI Flash BIOS	AMI SPI Flash BIOS	AMI SPI Flash BIOS	
<b>Memory</b>	<b>Technology</b>	DDR4-2400	DDR3L-1600	DDR3L-1333	
	<b>Max Capacity</b>	2 x DIMM, up to 64G 4x DIMM, up to 128G	Up to 16GB non-ECC/ECC	Up to 8GB non-ECC	Up to 8GB non-ECC
	<b>Socket</b>	2 x 288-pin R-DIMM/U-DIMM (Intel® C3338) 4 x 288-pin R-DIMM/U-DIMM (Intel® C3558/C3758)	2 x 240-pin U-DIMM	1 x 204-pin SO-DIMM	1 x 204-pin SO-DIMM
<b>Network Interface</b>	<b>Ethernet</b>	6 x 10/100/1000 Mbps (default) and 2 or 4 x 10GbE SFP+ (depends on CPU)	6 x 10/100/1000 Mbps	4 x 10/100/1000 Mbps (6 ports by request)	4 x 10/100/1000 Mbps (6 ports by request)
	<b>LAN Bypass</b>	1 pair (optional)	2 pairs (optional)	2 pairs (optional)	2 pairs (optional)
	<b>Controllers</b>	Intel® i210	Intel® i354 & i210	Intel® i211	Intel® i211
	<b>LAN Module</b>	N/A	N/A	N/A	N/A
<b>Storage</b>	<b>HDD</b>	1 x 2.5" HDD	1 x 2.5" HDD	1 x 2.5" HDD	1 x 2.5" HDD
	<b>CompactFlash™ / CFast™ /mSATA</b>	1 x mSATA	1 x CompactFlash™	1 x mSATA	1 x CompactFlash™
<b>I/O</b>	<b>USB</b>	2 x USB 2.0	2 x USB 2.0	2 x USB 3.0	1 x USB 2.0, 1 x USB 3.0
	<b>Console</b>	1 x RJ-45	1 x RJ-45	1 x RJ-45	1 x RJ-45
<b>Power Supply</b>	1 x 12V, 5A power adapter (Intel® C3338/C3558) 1 x 12V, 7A power adapter (Intel® C3758)	1 x 12V, 5A power adapter	1 x 12V, 5A power adapter	1 x 12V, 5A power adapter	
<b>Expansion Interface</b>	1 x PCI Express Mini Card slot	1 x PCI Express Mini Card slot (USB interface)	1 x PCI Express Mini Card slot (USB interface)	1 x PCI Express Mini Card slot (USB interface)	
<b>VGA/HDMI</b>	N/A	N/A	1 x HDMI (Optional)	Pin-header	
<b>Fanless</b>	N/A	N/A	Yes (NA345FL only)	N/A	
<b>Operating Temperature</b>	0°C to +40°C (+32°F to +104°F)	0°C to +40°C (+32°F to +104°F)	0°C to +40°C (+32°F to +104°F)	0°C to +40°C (+32°F to +104°F)	
<b>LCD Module</b>	N/A	N/A	N/A	N/A	
<b>OS Support</b>	Yocto, Linux	Yocto, Linux	Win 10, Linux	Win7, WES7, Win8, WE8S, Linux	
<b>Dimensions (H x W x D)</b>	44 x 231 x 197 mm (1.73" x 9.09" x 7.76")	44 x 231 x 197 mm (1.73" x 9.09" x 7.76")	44 x 231.9 x 152 mm (1.73" x 9" x 5.98")	44 x 231.9 x 152 mm (1.73" x 9" x 5.98")	
<b>Certifications</b>	CE/FCC	CE/FCC	CE/FCC	CE/FCC	

# NA362

Desktop Network Appliance Platform with Intel® Atom® Processor C3338/C3558/C3758 and up to 10 LANs

## Features

- Intel® Atom® processor C3338/C3558/C3758 (Denverton)
- Four DDR4 R-DIMM for up to 128GB of memory or U-DIMM for up to 64GB of memory
- Six 10/100/1000 Mbps Ethernet ports and four SFP+ ports
- Wi-Fi/3G/LTE through PCI Express Mini Card slot for optional
- Supports Intel® QuickAssist Technology
- Supports Intel® Data Plane Development Kit (Intel® DPDK)
- Suitable for VPN, network bandwidth controller, firewall and UTM applications



## Specifications

System	
CPU	Intel® Atom® processor C3338/C3558/C3758 (Denverton)
Chipset	SoC Integrated
Memory	4 x DDR4 R-DIMM (up to 128GB)/U-DIMM, up to 64GB non-buffer non-ECC/ECC memory (Atom® C3558/C3758) 2 x DDR4 R-DIMM (up to 64GB)/U-DIMM, up to 32GB non-buffer non-ECC/ECC memory (Atom® C3338)
BIOS	AMI SPI Flash BIOS
Storage	1 x 2.5" SATA3 HDD 1 x mSATA
Network Interface	6 x 10/100/1000 Mbps Ethernet (Intel® i210) (Atom® C3338) 6 x 10/100/1000 Mbps Ethernet (Intel® i210) and 2 x 10GbE SFP+ (Atom® C3558) 6 x 10/100/1000 Mbps Ethernet (Intel® i210) and 4 x 10GbE SFP+ (Atom® C3758)
I/O	1 x RS-232 (RJ-type) 2 x USB 2.0
Other Features	LAN Bypass function through latch relay (one pair) for optional
Expansion Interface	1 x PCI Express Mini Card slot (PCIe interface)
Watchdog Timer	255 stepping for system reset 8 stepping for LAN Bypass
Power Supply	1 x 12V, 5A power adapter (Atom® C3338/C3558) 1 x 12V, 7A power adapter (Atom® C3758)
OS Compatibility	Yocto, Linux

## Mechanical/ Environmental

Form Factor	1U desktop
LED	Power, HDD, GPIO programmable, LAN Bypass, Link/Act with transfer rate
Operating Temperature	0°C to +40°C (+32°F to +104°F)
Humidity	10% to 95% RH, non-condensing
Chassis Material	Steel
Dimensions	44 mm (1.73") (H) x 231 mm (9.09") (W) x 197 mm (7.76")
Weight (net/gross)	1.64 kg (3.62 lb)/2.54 kg (5.60 lb) with 12V/5A adapter (C3338/C3558) 1.64 kg (3.62 lb)/2.69 kg (5.93 lb) with 12V/7A adapter (C3758)
Certifications	FCC class B/CE class B

## Packing List

- 1 x DC power adapter 12V/5A or 12V/7A
- 1 x Power cord
- 1 x SATA cable

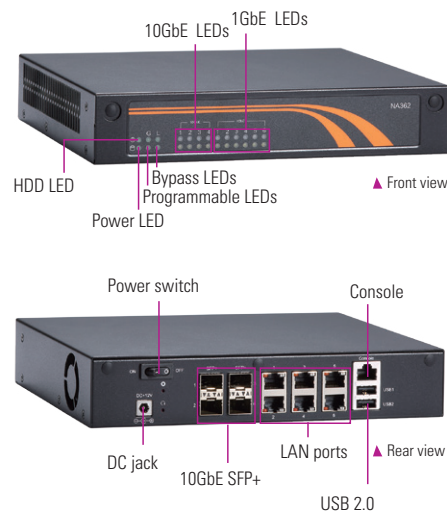

## Ordering Information

Standard	
NA362-D6GI-C3338-US	1U compact network appliance with Intel® Atom® w/o LBP (P/N: E26E362102) processor C3338, 2 R-DIMM/U-DIMM and 6 GbE LANs
NA362-D6GI-C3558-US	1U compact network appliance with Intel® Atom® w/o LBP (P/N: E26E362100) processor C3558, 4 R-DIMM/U-DIMM and 6 GbE LANs
NA362-D8MI-C3558-US	1U compact network appliance with Intel® Atom® w/o LBP (P/N: E26E362105) processor C3558, 4 R-DIMM/U-DIMM, 6 GbE LANs and 2 10GbE SFP+ ports
NA362-DAMI-C3758-US	1U compact network appliance with Intel® Atom® w/ LBP (P/N: E26E362101) processor C3758, 4 R-DIMM/U-DIMM, 6 GbE LANs and 4 10GbE SFP+ ports

## Optional

5916E552000E	DB9F-RJ-45 1.8M console cable for Cisco
--------------	---

\* Specifications and certifications may vary based on different requirements.

## Dimensions

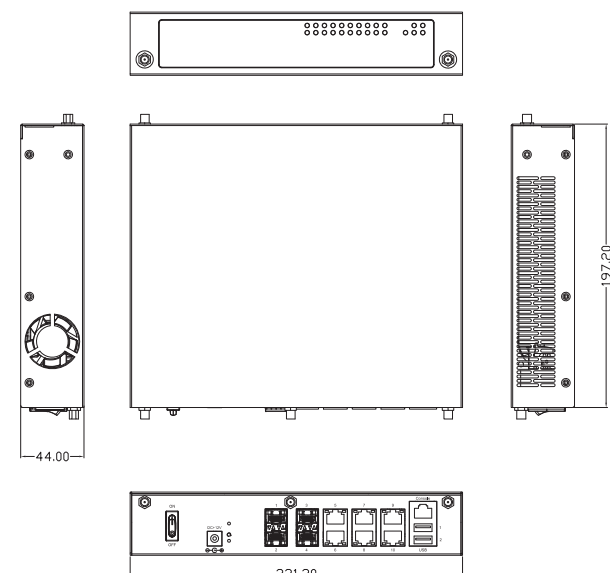

# NA361

Desktop Network Appliance Platform with Intel® Atom® Processor C2358 and 6 LANs

## Features

- Intel® Atom® processor C2358 (Rangeley)
- Two DDR3-1600 U-DIMM for up to 16GB of memory
- Six 10/100/1000 Mbps Ethernet ports (Intel® i354 & Intel® i210)
- Wi-Fi/3G/LTE through PCI Express Mini Card for optional
- Supports Intel® QuickAssist Technology
- Supports Intel® Data Plane Development Kit (Intel® DPDK)
- Suitable for VPN, network bandwidth controller, firewall and UTM applications



## Specifications

System	
CPU	Intel® Atom® processor C2358 (2-core) (Rangeley)
Chipset	SoC Integrated
Memory	2 x DDR3-1600 U-DIMM, up to 16GB non-buffer non-ECC/ECC memory
BIOS	AMI SPI Flash BIOS
Storage	1 x 2.5" SATA HDD 1 x CompactFlash™ type-II 1 x mSATA (optional) 1 x CFast™ (optional)
Network Interface	6 x 10/100/1000 Mbps Ethernet (Intel® i354 & Intel® i210) 4 x RJ-45 + 2 x SFP (optional)
I/O	1 x RS-232 (RJ-type) 2 x USB 2.0 6 x RJ-45
Other Features	LAN Bypass function through latch relay (two pairs) for optional
Expansion Interface	1 x PCI Express Mini Card slot with USB interface
Watchdog Timer	255 stepping for system reset 8 stepping for LAN Bypass
Power Supply	1 x 12V, 5A power adapter
OS Compatibility	Yocto, Linux

## Mechanical/ Environmental

Form Factor	1U desktop
LED	Power, HDD, GPIO programmable, LAN Bypass, Link/Act with transfer rate
Operating Temperature	0°C to +40°C (+32°F to +104°F)
Humidity	10% to 95% RH, non-condensing
Chassis Material	Steel
Dimensions	44 mm (1.73") (H) x 231 mm (9.09") (W) x 197 mm (7.76")
Weight (net/gross)	2.35 kg (5.18 lb)/2.61 kg (5.75 lb)
Certifications	FCC class B/CE class B

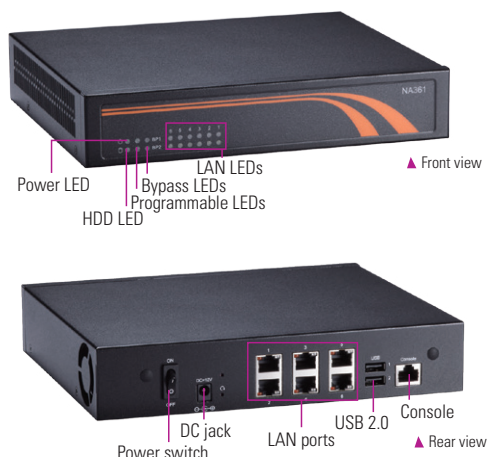

## Ordering Information

Standard	
NA361-D6GI-2358-US (P/N: E26E361100)	1U compact network appliance with Intel® Atom® processor C2358 and 6 GbE LANs
NA361-D6GI-2358-US w/ LBP (P/N: E26E361101)	1U compact network appliance with Intel® Atom® processor C2358, 6 GbE LANs and LAN Bypass
Optional	
5916E552000E	DB9F-RJ-45 1.8M console cable for Cisco

\* Specifications and certifications may vary based on different requirements.

## Packing List

- 1 x DC power adapter 12V/5A
- 1 x Power cord
- 1 x SATA cable

## Dimensions

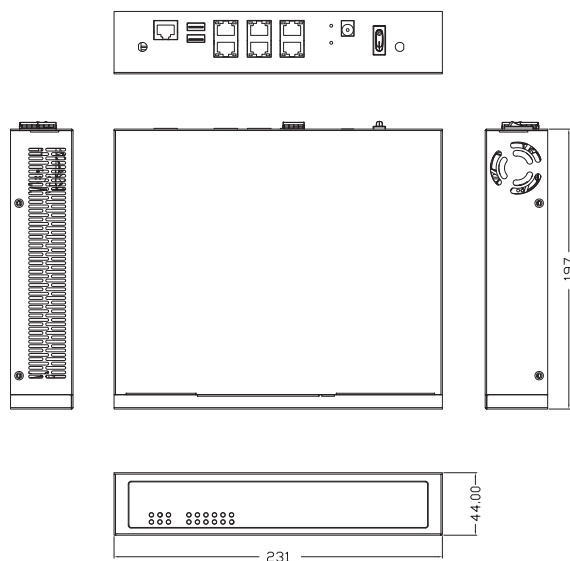



# NA345

Desktop Network Appliance Platform with Intel® Pentium® Processor N4200/Celeron® Processor N3350 and 4 LANs

## Features

- Intel® Pentium® processor N4200/Celeron® processor N3350 (Apollo Lake)
- One DDR3L-1866 SO-DIMM for up to 8GB of memory
- Four 10/100/1000 Mbps Ethernet ports (Intel® i211)
- Wi-Fi/3G/LTE through PCI Express Mini Card slot for optional
- Suitable for VPN, network bandwidth controller and firewall applications

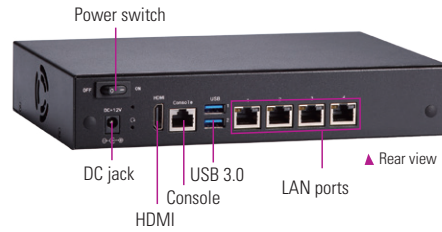
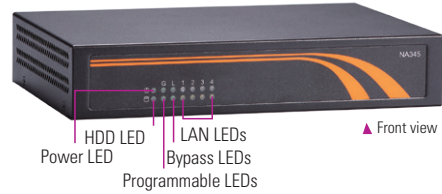

## Specifications

System	
CPU	Intel® Pentium® processor N4200 (Apollo Lake) Intel® Celeron® processor N3350 (Apollo Lake)
Chipset	SoC Integrated
Memory	1 x DDR3L-1866 SO-DIMM, up to 8GB non-ECC memory
BIOS	AMI SPI Flash BIOS
Storage	1 x 2.5" SATA 3 HDD 1 x mSATA
Network Interface	4 x 10/100/1000 Mbps Ethernet (Intel® i211, optional 6 ports by request)
I/O	1 x RS-232 (RJ-type) 2 x USB 3.0 4 x RJ-45 1 x HDMI (optional)
Other Features	LAN Bypass function through latch relay (two pairs) for optional
Expansion Interface	1 x PCI Express Mini Card slot with USB interface
Watchdog Timer	255 stepping for system reset 8 stepping for LAN Bypass
Power Supply	1 x 12V, 5A power adapter
OS Compatibility	Win 10, Linux

## Mechanical/ Environmental

Form Factor	1U desktop
LED	Power, HDD, GPIO programmable, LAN Bypass, Link/Act with transfer rate
Operating Temperature	0°C to +40°C (+32°F to +104°F)
Humidity	10% to 95% RH, non-condensing
Chassis Material	Steel
Dimensions	44 mm (1.73") (H) x 231.9 mm (9.00") (W) x 152 mm (5.98") (D)
Weight (net/gross)	2.35 kg (5.18 lb)/2.61 kg (5.75 lb)
Certifications	FCC class B/CE class B

## Ordering Information

Standard	
NA345-D4GI-N3350-US w/o LBP (P/N: E26E345100)	1U desktop network appliance with Intel® Celeron® processor N3350 and 4 GbE LANs
NA345-D4GI-N4200-US w/o LBP (P/N: E26E345102)	1U desktop network appliance platform with Intel® Pentium® processor N4200 and 4 GbE LANs
NA345-D6GI-N4200-US & HDMI w/ 2 LBP (P/N: E26E345103)	1U desktop network appliance platform with Intel® Pentium® processor N4200, 6 GbE LANs, 2 LAN Bypass & HDMI

## Optional

5916E552000E	DB9F-RJ-45 1.8M console cable for Cisco
--------------	---

\* Specifications and certifications may vary based on different requirements.

## Packing List

- 1 x DC power adapter 12V/5A
- 1 x Power cord
- 1 x SATA cable

## Dimensions

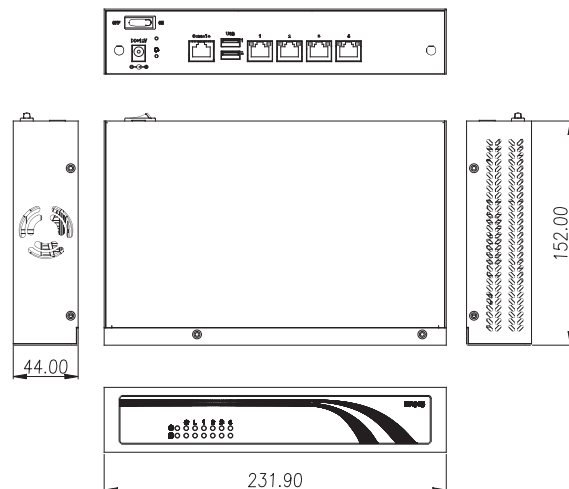

# NA342

Desktop Network Appliance Platform with Intel® Celeron® Processor J1900 and 4 LANs

## Features

- Intel® Celeron® processor J1900 (Bay Trail)
- One DDR3L-1333 SO-DIMM for up to 8GB of memory
- Four 10/100/1000 Mbps Ethernet ports (Intel® i211)
- Wi-Fi/3G/LTE through PCI Express Mini Card slot for optional
- Suitable for VPN, network bandwidth controller and firewall applications

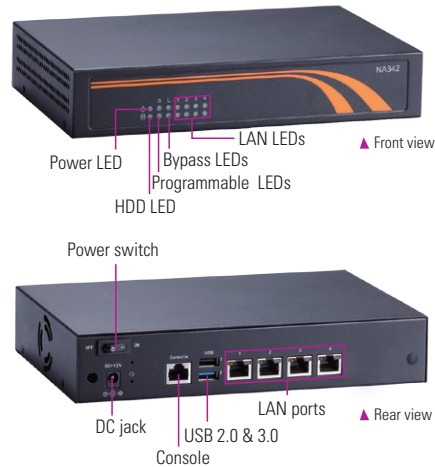

## Specifications

System	
CPU	Intel® Celeron® processor J1900 (Bay Trail)
Chipset	SoC integrated
Memory	1 x DDR3L-1333 SO-DIMM, up to 8GB non-ECC memory
BIOS	AMI SPI Flash BIOS
Storage	1 x 2.5" SATA HDD 1 x CompactFlash™ type-II
Network Interface	4 x 10/100/1000 Mbps Ethernet (Intel® i211, optional 6 ports by request)
I/O	1 x RS-232 (RJ-type) 1 x USB 2.0 1 x USB 3.0 4 x RJ-45
Other Features	LAN Bypass function through latch relay (two pairs) for optional
Expansion Interface	1 x PCI Express Mini Card slot with USB interface
Watchdog Timer	255 stepping for system reset 8 stepping for LAN Bypass
Power Supply	1 x 12V, 5A power adapter
OS Compatibility	Win7, WES7, Win8, WE8S, Linux

## Mechanical / Environmental

Form Factor	1U desktop
LED	Power, HDD, GPIO programmable, LAN Bypass, Link/Act with transfer rate
Operating Temperature	0°C to +40°C (+32°F to +104°F)
Humidity	10% to 95% RH, non-condensing
Chassis Material	Steel
Dimensions	44 mm (1.73") (H) x 231.9 mm (9.00") (W) x 152 mm (5.98") (D)
Weight (net/gross)	2.5 kg (5.51 lb)/2.9 kg (6.39 lb)
Certifications	FCC class B/CE class B

## Ordering Information

Standard	
NA342-D4G1-1900-B-US	1U desktop network appliance with Intel® Celeron® w/o LBP (PN: E26E342103) processor J1900 and 4 GbE LANs

Optional	
5916E552000E	DB9F-RJ-45 1.8M console cable

\* Specifications and certifications may vary based on different requirements.

## Packing List

- 1 x DC power adapter 12V/5A
- 1 x Power cord
- 1 x SATA cable

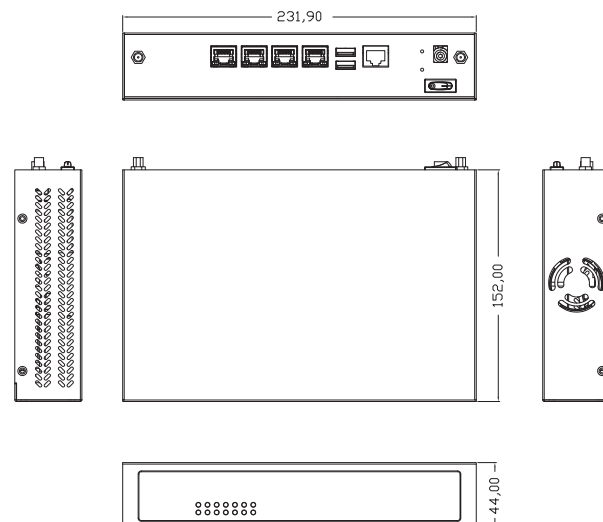

## Dimensions



# 2

## SMB Network Appliances

Axiomtek's SMB (small and medium business) network appliance platforms with 1U/2U rackmount form factor, enclosure management capability, flexible configurations and various combinations of Ethernet modules (1G/10G/25G/40G/Copper/Fiber/Bypass), are suitable for different environments and applications. Axiomtek's SMB series provides not only high computing performance and reliable hardware platforms, but also system development kits for software integration.

Selection Guide		357
<b>2U Network Appliances</b>		
NA860	2U Rackmount Network Appliance Platform with Dual LGA3647 Socket Intel® Skylake Server Processors, Intel® C621 (Purley) and up to 66 LANs	359
NA850	2U Rackmount Network Appliance Platform with Dual LGA2011 Socket Intel® Xeon® E5-2600 v3/v4 Family Processors, Intel® C612 and up to 42 LANs	360
<b>1U Network Appliances</b>		
 NA861	1U Rackmount Network Appliance Platform with LGA3647 Socket Intel® Skylake Server Processor, Intel® C621 (Purley) and up to 34 LANs	361
 NA590	1U Rackmount Network Appliance Platform with LGA1151 Socket Intel® Core™/Xeon® E-2100 Series Processor, Intel® C246/H310 and up to 26 LANs	362
NA580	1U Rackmount Network Appliance Platform with LGA1151 Socket Intel® Xeon® E3/Core™ Processor and 8 LANs	363
NA362R	1U Rackmount Network Appliance Platform with Intel® Atom® Processor C3558/C3758 and up to 10 LANs	364

# Network Appliances

# SMB Network Appliances

## Selection Guide



NEW



Features \ Models	NA860	NA850	NA861	
<b>Form Factor</b>	2U, 19" rackmount	2U, 19" rackmount	1U, 19" rackmount	
<b>Processor</b>	Dual LGA3647 Intel® Skylake server processors	LGA2011 Intel® Xeon® E5-2600 v3	LGA3647 Intel® Skylake server processor	
<b>Chipset</b>	Intel® C621	Intel® C612	Intel® C621	
<b>BIOS</b>	AMI SPI Flash BIOS	AMI SPI Flash BIOS	AMI SPI Flash BIOS	
<b>Memory</b>	<b>Technology</b>	DDR4-2400	DDR4-2400	
	<b>Max Capacity</b>	Up to 384GB non-ECC/ECC	Up to 512GB non-ECC/ECC	Up to 192GB non-ECC/ECC
	<b>Socket</b>	12 x 288-pin R-DIMM	16 x 288-pin R-DIMM	6 x 288-pin R-DIMM
<b>Network Interface</b>	<b>Ethernet (default)</b>	2 x 10/100/1000 Mbps	2 x 10/100/1000 Mbps	2 x 10/100/1000 Mbps
	<b>Ethernet (max.)</b>	66 x 10/100/1000 Mbps	42 x 10/100/1000 Mbps	34 x 10/100/1000 Mbps
	<b>LAN Bypass</b>	Depends on LAN module	Depends on LAN module	Depends on LAN module
	<b>LAN Module</b>	8 NIC slots (Dual CPUs) 4 NIC slots (Single CPU)	5 NIC slots (Dual CPUs) 3 NIC slots (Single CPU)	4 NIC slots
<b>Storage</b>	<b>HDD</b>	2 x 2.5" HDD (hot swappable)	2 x 3.5" HDD (hot swappable)	2 x 2.5" HDD
	<b>CompactFlash™ / CFast™ / mSATA</b>	1 x mSATA	1 x CompactFlash™	1 x mSATA
<b>I/O</b>	<b>USB</b>	2 x USB 3.0	2 x USB 3.0	2 x USB 2.0
	<b>Console</b>	1 x RJ-45	1 x RJ-45	1 x RJ-45
	<b>VGA</b>	Yes	Yes	Yes
<b>Power Supply</b>	800W 2U redundant	650W 2U redundant	400W 1U redundant	
<b>Expansion Interface</b>	2 x PCIe x8 (optional)	2 x PCIe x8 (optional)	N/A	
<b>Operating Temperature</b>	0°C to +40°C (+32°F to +104°F)	0°C to +45°C (+32°F to +113°F)	0°C to +40°C (+32°F to +104°F)	
<b>LCD Module</b>	Yes	Yes	Yes	
<b>OS Support</b>	Linux Kernel	Linux Kernel	Linux Kernel	
<b>Dimensions (H x W x D)</b>	88 x 430 x 562 mm (3.46" x 16.93" x 22")	88 x 430 x 550 mm (3.46" x 16.93" x 21.65")	44 x 430 x 562 mm (1.73" x 16.93" x 22")	
<b>Certifications</b>	CE/FCC	CE/FCC	CE/FCC	

NEW



Features \ Models	NA590	NA580	NA362R	
<b>Form Factor</b>	1U, 19" rackmount	1U, 19" rackmount	1U, 19" rackmount	
<b>Processor</b>	LGA1151 Intel® Xeon® E/Intel® Core™ (Coffee Lake)	LGA1151 Intel® Xeon® E3/Intel® Core™	Intel® Atom® C3558/C3758	
<b>Chipset</b>	Intel® C246/H310	Intel® C236/H110	SoC integrated	
<b>BIOS</b>	AMI SPI Flash BIOS	AMI SPI Flash BIOS	AMI SPI Flash BIOS	
<b>Memory</b>	<b>Technology</b>	DDR4-2666	DDR4	
	<b>Max Capacity</b>	Up to 64GB non-ECC/ECC	Up to 64GB non-ECC/ECC	Up to 128GB non-ECC/ECC
	<b>Socket</b>	4 x 288-pin R-DIMM (Intel® C246) 2 x 288-pin R-DIMM (Intel® H310)	4 x 288-pin R-DIMM (Intel® C236) 2 x 288-pin R-DIMM (Intel® H110)	4 x 288-pin R-DIMM/U-DIMM
<b>Network Interface</b>	<b>Ethernet (default)</b>	8 x 10/100/1000 Mbps (Intel® C246) 6 x 10/100/1000 Mbps (Intel® H310)	8 x 10/100/1000 Mbps (Intel® C236) 6 x 10/100/1000 Mbps (Intel® H110)	6 x 10/100/1000 Mbps 4 x 10G SFP+
	<b>Ethernet (max.)</b>	26 x 10/100/1000 Mbps	18 x 10/100/1000 Mbps	6 x 10/100/1000 Mbps 4 x 10G SFP+
	<b>LAN Bypass</b>	2 pairs	2 pairs	1 pair
	<b>LAN Module</b>	2 NIC slots	1 NIC slot	N/A
<b>Storage</b>	<b>HDD</b>	2 x 2.5" HDD or 1 x 3.5" HDD (optional)	2 x 2.5" HDD or 1 x 3.5" HDD (optional)	2 x 2.5" HDD or 1 x 3.5" HDD (optional)
	<b>CompactFlash™ / CFast™ / mSATA</b>	1 x mSATA	1 x CFast™ 1 x mSATA	1 x mSATA
<b>I/O</b>	<b>USB</b>	2 x USB 3.0	2 x USB 3.0	2 x USB 2.0
	<b>Console</b>	1 x RJ-45	1 x RJ-45	1 x RJ-45
	<b>VGA</b>	Pin header	Pin header	N/A
<b>Power Supply</b>	270W ATX power 300W 1U redundant (optional)	270W ATX power 280W 1U redundant (optional)	84W open frame	
<b>Expansion Interface</b>	1 x PCIe x8 (Intel® C246 only)	1 x PCIe x8 (Intel® C236 only)	N/A	
<b>Operating Temperature</b>	0°C to +45°C (+32°F to +113°F) (270W ATX power) 0°C to +40°C (+32°F to +104°F) (300W 1U redundant)	0°C to +45°C (+32°F to +113°F) (270W ATX power) 0°C to +40°C (+32°F to +104°F) (280W 1U redundant)	0°C to +45°C (+32°F to +113°F)	
<b>LCD Module</b>	Yes	Yes	Yes	
<b>OS Support</b>	Linux Kernel	Linux Kernel	Yocto, Linux	
<b>Dimensions (H x W x D)</b>	44 x 430 x 450 mm (1.73" x 16.93" x 17.7")	44 x 430 x 450 mm (1.73" x 16.93" x 17.7")	44 x 430 x 250 mm (1.73" x 16.93" x 9.84")	
<b>Certifications</b>	CE/FCC	CE/FCC	CE/FCC	

1  
2  
3  
SMB Network Appliances

# NA860

2U Rackmount Network Appliance Platform with Dual LGA3647 Socket Intel® Skylake Server Processors, Intel® C621 (Purley) and up to 66 LANs

## Features

- Dual LGA3647 socket Intel® Skylake server processors
- Twelve DDR4-2400 R-DIMM for up to 384GB of memory
- Max. up to sixty-six 10/100/1000 Mbps Ethernet ports
- Eight expandable LAN modules supporting 1GbE/10GbE/25GbE/40GbE/Fiber/Copper/Bypass
- Supports 2U redundant power supply
- Supports IPMI/TPM (onboard) for optional
- High computing power for SDN, NGFW, IDS, IPS and UTM applications



## Specifications

System	
CPU	Dual LGA3647 socket Intel® Skylake server processors
Chipset	Intel® C621
Memory	12 x DDR4-2400 R-DIMM, up to 384GB non-buffer non-ECC/ECC memory
BIOS	AMI SPI Flash BIOS
Storage	2 x 2.5" SATA HDD hot swappable 1 x mSATA
Network Interface	2 x 10/100/1000 Mbps Ethernet (Intel® i210) Single CPU: 4 x LAN module (optional), max. up to 34 LAN ports Dual CPU: 8 x LAN module (optional), max. up to 66 LAN ports
I/O	1 x RS-232 (RJ-type) 2 x USB 3.0 2 x RJ-45 1 x VGA
Other Features	LAN Bypass function through latch relay (depends on LAN modules)
Expansion Interface	2 x PCIe x8 through AX96709 (83967091000E) riser card (optional)
Watchdog Timer	255 stepping for system reset 8 stepping for LAN Bypass
Power Supply	800W 2U redundant power supply
OS Compatibility	Linux Kernel

## Mechanical/ Environmental

Form Factor	2U rackmount
LED	Power, HDD, GPIO programmable, LAN Bypass, Link/Act with transfer rate
Operating Temperature	0°C to +40°C (+32°F to +104°F)
Humidity	10% to 95% RH, non-condensing
Chassis Material	Steel
Dimensions	88 mm (3.46") (H) x 430 mm (16.92") (W) x 562 mm (22.12") (D)
Weight (net/gross)	12 kg (26.4 lb)/20 kg (44 lb)
Certifications	FCC class A/CE class A

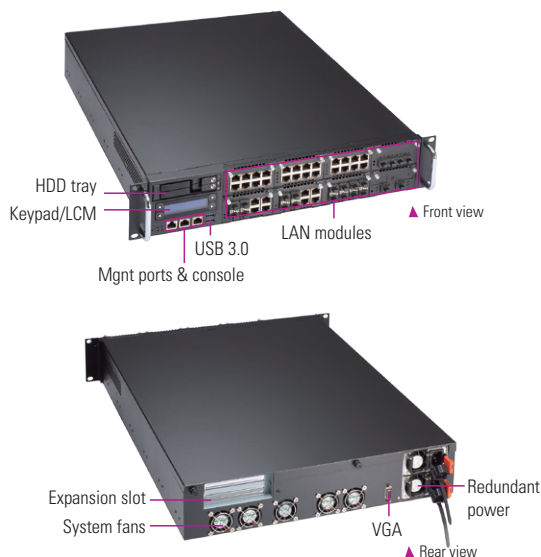

## Ordering Information

Standard	
NA860-R2GI-C621-US (P/N: E26E860100)	2U rackmount appliance with dual LGA3647 socket Intel® Skylake server processors and 2 GbE LANs

## Optional

5916E552000E	DB9F-RJ-45 1.8M console cable for Cisco
--------------	---

\* Specifications and certifications may vary based on different requirements.

## Packing List

- 1 x SATA cable
- 1 x Power cord

## Dimensions

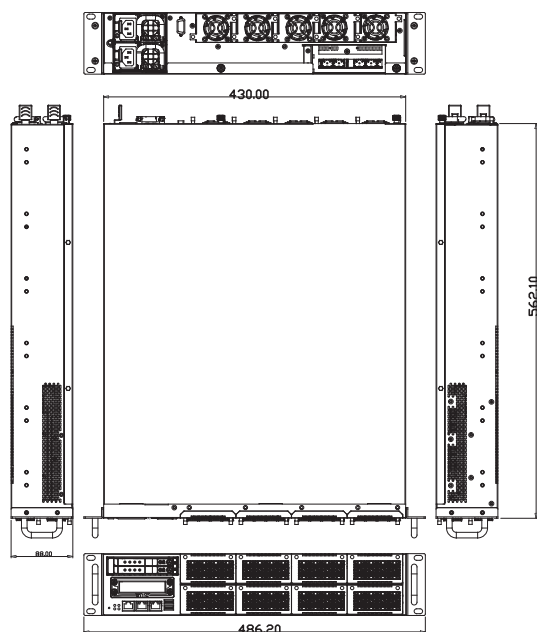



# NA850

2U Rackmount Network Appliance Platform with Dual LGA2011 Socket Intel® Xeon® E5-2600 v3/v4 Family Processors, Intel® C612 and up to 42 LANs

## Features

- Dual LGA2011 socket-R3 Intel® Xeon® E5-2600 v3/v4 family processors
- Sixteen DDR4-2133 R-DIMM for up to 512GB of memory
- Max. up to forty-two 10/100/1000 Mbps Ethernet ports
- Five expandable LAN modules supporting 1GbE/10GbE/25GbE/40GbE/Fiber/Copper/Bypass
- Supports 2U redundant power supply
- High computing power for SDN, NGFW, IDS, IPS and UTM applications



## Specifications

System	
CPU	Dual LGA2011 socket Intel® Xeon® E5-2600 v3/v4 family processors
Chipset	Intel® C612
Memory	16 x DDR4-2133 R-DIMM, up to 512GB non-buffer non-ECC/ECC memory
BIOS	AMI SPI Flash BIOS
Storage	2 x 3.5" SATA HDD, hot swappable 1 x CompactFlash™ type-II 1 x CFast™ (optional)
Network Interface	2 x 10/100/1000 Mbps Ethernet (Intel® i211) Single CPU: 3 x LAN modules (optional), max. up to 26 LANs Dual CPU: 5 x LAN modules (optional), max. up to 42 LANs
I/O	1 x RS-232 (RJ-type) 2 x USB 3.0 2 x RJ-45 1 x VGA
Other Features	LAN Bypass function through latch relay (depends on LAN modules)
Expansion Interface	2 x PCIe x8 through AX96709 (83967091000E) riser card (optional)
Watchdog Timer	255 stepping for system reset 8 stepping for LAN Bypass
Power Supply	650W 2U redundant power supply
OS Compatibility	Linux Kernel

## Mechanical/ Environmental

Form Factor	2U rackmount
LED	Power, HDD, GPIO programmable, LAN Bypass, Link/Act with transfer rate
Operating Temperature	0°C to +45°C (+32°F to +113°F)
Humidity	10% to 95% RH, non-condensing
Chassis Material	Steel
Dimensions	88 mm (3.46") (H) x 430 mm (16.92") (W) x 550 mm (21.65") (D)
Weight (net/gross)	13 kg (28.6 lb)/16 kg (35.2 lb)
Certifications	FCC class A/CE class A

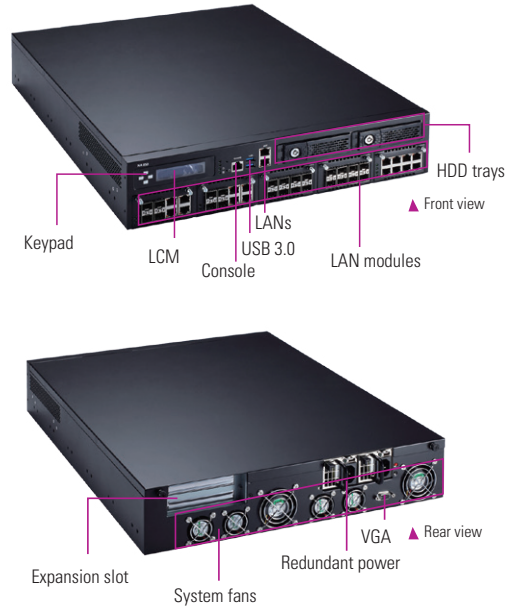

## Ordering Information

Standard	
NA850-R2GI-RC-US (P/N: E26E850100)	2U rackmount appliance with dual LGA2011 Intel® Xeon® E5-2600 v3/v4 family processors and 2 GbE LANs

Optional	
5916E552000E	DB9F-RJ-45 1.8M console cable for Cisco

\* Specifications and certifications may vary based on different requirements.

## Packing List

- 1 x SATA cable
- 1 x Power cord

## Dimensions

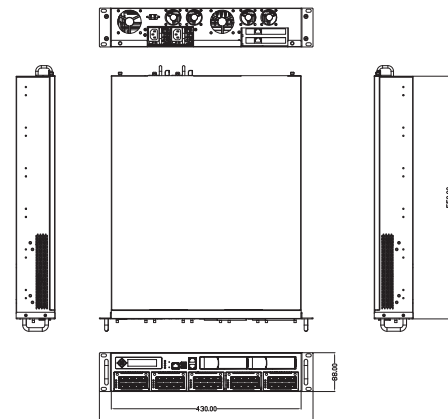

# NA861 NEW

1U Rackmount Network Appliance Platform with LGA3647 Socket Intel® Skylake Server Processor, Intel® C621 (Purley) and up to 34 LANs

## Features

- LGA3647 socket Intel® Skylake server processor
- Six DDR4-2400 R-DIMM for up to 384GB of memory
- Max. up to thirty-four 10/100/1000 Mbps Ethernet ports
- Four expandable LAN modules supporting 1GbE/10GbE/25GbE/40GbE/Fiber/Copper/Bypass
- Supports 1U redundant power supply
- Supports IPMI/TPM (onboard) for optional
- High computing power for SDN, NGFW, IDS, IPS and UTM applications

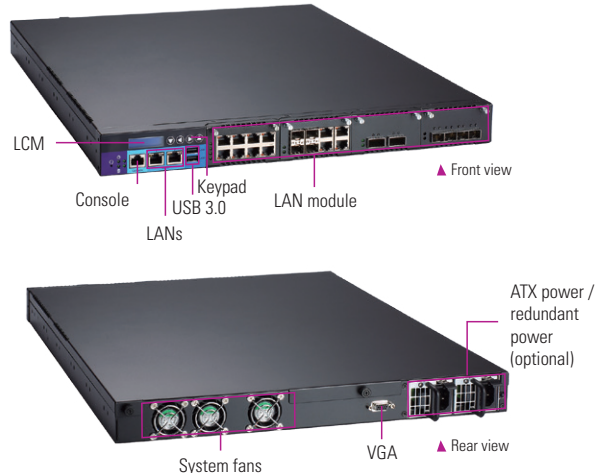

## Specifications

System	
CPU	LGA3647 socket Intel® Skylake server processors
Chipset	Intel® C621
Memory	6 x DDR4-2400 R-DIMM, up to 192GB non-buffer non-ECC/ECC memory
BIOS	AMI SPI Flash BIOS
Storage	2 x 2.5" SATA HDD 1 x mSATA
Network Interface	2 x 10/100/1000 Mbps Ethernet (Intel® i210) Single CPU: 4 x LAN module (optional), max. up to 34 LAN ports
I/O	1 x RS-232 (RJ-type) 2 x USB 2.0 2 x RJ-45 1 x VGA
Other Features	LAN Bypass function through latch relay (depends on LAN modules)
Expansion Interface	N/A
Watchdog Timer	255 stepping for system reset 8 stepping for LAN Bypass
Power Supply	400W 1U redundant power supply
OS Compatibility	Linux Kernel

## Mechanical/ Environmental

Form Factor	1U rackmount
LED	Power, HDD, GPIO programmable, LAN Bypass, Link/Act with transfer rate
Operating Temperature	0°C to +40°C (+32°F to +104°F)
Humidity	10% to 95% RH, non-condensing
Chassis Material	Steel
Dimensions	44 mm (1.73") (H) x 430 mm (16.92") (W) x 561 mm (22") (D)
Weight (net/gross)	8 kg (17.6 lb)/12 kg (26.4 lb)
Certifications	FCC class A/CE class A

## Ordering Information

Standard	
NA861-R2GI-US with Redn power (P/N: E26E861100)	1U rackmount appliance with Intel® Skylake server processor, 2 GbE LANs and redundant power
NA861-R2GI-US with Single power (P/N: E26E861101)	1U rackmount appliance with single Intel® Skylake server processor, 2 GbE LANs and single power

## Optional

5916E552000E	DB9F-RJ-45 1.8M console cable for Cisco
--------------	---

\* Specifications and certifications may vary based on different requirements.

## Packing List

- 1 x SATA cable
- 1 x Power cord

## Dimensions

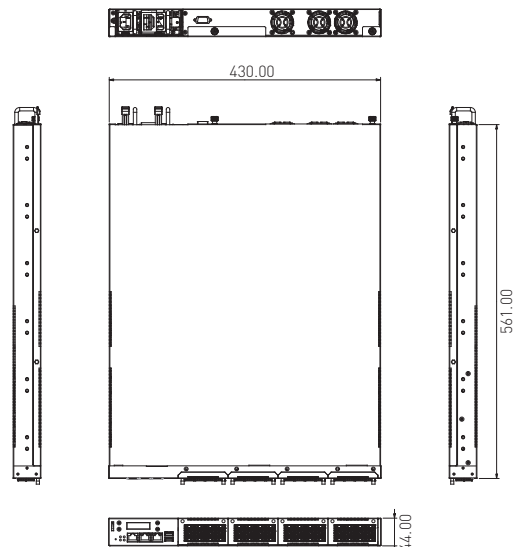

# NA590 NEW

1U Rackmount Network Appliance Platform with LGA1151 Socket  
Intel® Core™/Xeon® E-2100 Series Processor, Intel® C246/H310 and up to 26 LANs

## Features

- LGA1151 socket 8th Intel® Core™/Xeon® E-2100 series processor (Coffee Lake)
- Four DDR4-2666 U-DIMM for up to 64GB of memory
- Max. up to twenty-six 10/100/1000 Mbps Ethernet ports
- Two expandable LAN modules supporting 1GbE/10GbE/25GbE/40GbE/Fiber/Copper/Bypass
- Supports 1U redundant power supply for optional
- Supports IPMI/TPM for optional
- Suitable for network security, cloud computing and data centers applications

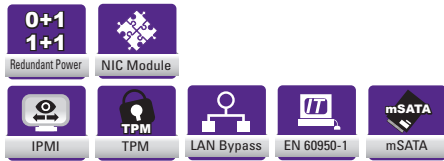

## Specifications

System	
CPU	LGA1151 socket 8th gen Intel® Core™/Xeon® E-21XX processor (Coffee Lake)
Chipset	Intel® C246/H310
Memory	Intel® C246: 4 x DDR4-2666 U-DIMM, up to 64GB non-buffer non-ECC/ECC memory Intel® H310: 2 x DDR4-2666 U-DIMM, up to 32GB non-buffer non-ECC memory
BIOS	AMI SPI Flash BIOS
Storage	2 x 2.5" SATA HDD 1 x mSATA 1 x 3.5" SATA HDD (optional for 270W ATX power supply only)
Network Interface	C246: 8 x 10/100/1000 Mbps (Intel® i210) 10 x 10/100/1000 Mbps (by project) 2 x LAN module (optional), max. up to 26 LANs H310: 6 x 10/100/1000 Mbps (Intel® i210) 1 x LAN module (optional), max. up to 14 LANs
I/O	1 x RS-232 (RJ-type) 2 x USB 3.0 8 x RJ-45
Other Features	LAN Bypass function through latch relay (two pairs)
Expansion Interface	1 x PCIe x8 (Intel® C246 only) through AX96708 (83967081010E) riser card (optional)
Watchdog Timer	255 stepping for system reset 8 stepping for LAN Bypass
Power Supply	270W ATX power supply 300W 1U redundant power supply (by project)
OS Compatibility	Linux Kernel

## Mechanical/ Environmental

Form Factor	1U rackmount
LED	Power, HDD, GPIO programmable, LAN Bypass, Link/Act with transfer rate
Operating Temperature	0°C to +45°C (+32°F to +113°F) (270W ATX power supply) 0°C to +40°C (+32°F to +104°F) (300W 1U redundant power supply)
Humidity	10% to 95% RH, non-condensing
Chassis Material	Steel
Dimensions	44 mm (1.73") (H) x 430 mm (16.93") (W) x 450 mm (17.7") (D)
Weight (net/gross)	6 kg (13.2 lb)/10 kg (22 lb)
Certifications	FCC class A, CE class A

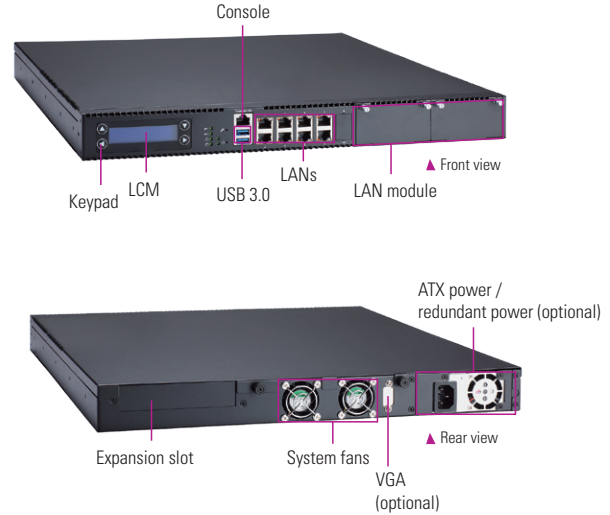

## Ordering Information

Standard	
NA590-R8GI-C246 (P/N: E26E590100)	1U rackmount appliance with LGA1151 socket Intel® Core™/Xeon® E-2100 processor (Coffee Lake), 8 GbE LANs, 2-pair LAN bypass and 2 expandable LAN modules (optional)
NA590-R6GI-H310 (P/N: E26E590101)	1U rackmount appliance with LGA1151 socket Intel® Core™ processor, 6 GbE LANs, 2-pair LAN bypass and 1 expandable LAN module (optional)

Optional	
5916E552000E	DB9F-RJ-45 1.8M console cable for Cisco

\* Specifications and certifications may vary based on different requirements.

## Packing List

- 1 x SATA cable
- 1 x Power cord

## Dimensions

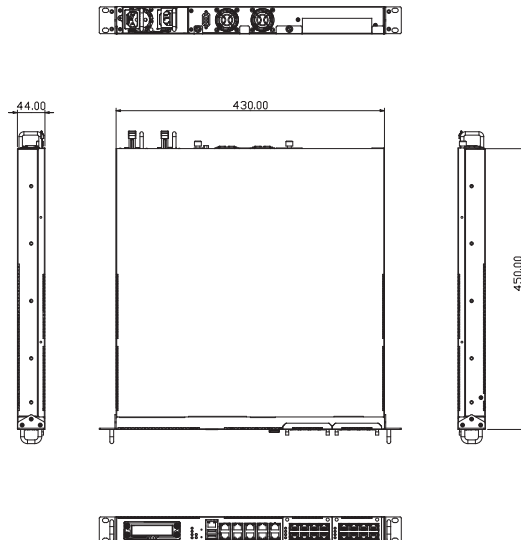

# NA580

1U Rackmount Network Appliance Platform with LGA1151 Socket Intel® Xeon® E3/Core™ Processor and 8 LANs

## Features

- LGA1151 socket 6th/7th gen Intel® Core™/Xeon® E3 processor (Skylake/Kaby Lake)
- Four DDR4-2400 U-DIMM for up to 64GB of memory
- Max. up to eighteen 10/100/1000 Mbps Ethernet ports
- One expandable LAN module supporting 1GbE/10GbE/Fiber/Copper/Bypass
- Supports 1U redundant power supply for optional
- Supports IPMI/TPM module for optional
- Suitable for network security, cloud computing and data centers applications

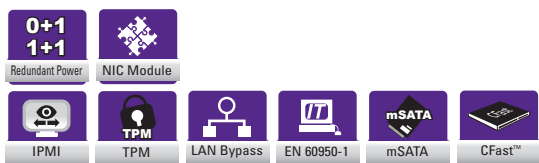

## Specifications

System	
CPU	LGA1151 socket Intel® Xeon® E3/Core™ processor (Skylake/Kaby Lake)
Chipset	Intel® C236/H110
Memory	Intel® C236: 4 x DDR4-2400 U-DIMM, up to 64GB non-buffer non-ECC/ECC memory Intel® H110: 2 x DDR4-2400 U-DIMM, up to 32GB non-buffer non-ECC memory
BIOS	AMI SPI Flash BIOS
Storage	2 x 2.5" SATA HDD 1 x CFast™ 1 x mSATA 1 x 3.5" SATA HDD (optional for 270 W ATX power supply only)
Network Interface	C236 PCH: 8 x 10/100/1000 Mbps Ethernet (Intel® i210) 10 x 10/100/1000 Mbps Ethernet (optional) 8 x RJ-45 + 2 x SFP (optional) H110 PCH: 6 x 10/100/1000 Mbps Ethernet (Intel® i210) 1 x LAN module (optional), max. up to 18 LANs
I/O	1 x RS-232 (RJ-type) 2 x USB 3.0 8 x RJ-45
Other Features	LAN Bypass function through latch relay (two pairs)
Expansion Interface	1 x PCIe x8 (Intel® C236 only) through AX96708 (83967081010E) riser card (optional)
Watchdog Timer	255 stepping for system reset 8 stepping for LAN Bypass
Power Supply	270W ATX power supply 280W 1U redundant power supply (optional)
OS Compatibility	Linux Kernel
Note : Kaby lake doesn't support Cent OS 6.6/6.7/6.8	

## Mechanical/ Environmental

Form Factor	1U rackmount
LED	Power, HDD, GPIO programmable, LAN Bypass, Link/Act with transfer rate
Operating Temperature	0°C to +45°C (+32°F to +113°F) (270 W ATX power supply) 0°C to +40°C (+32°F to +104°F) (280 W 1U redundant power supply)
Humidity	10% to 95% RH, non-condensing
Chassis Material	Steel
Dimensions	44 mm (1.73") (H) x 430 mm (16.93") (W) x 450 mm (17.7") (D)
Weight (net/gross)	6 kg (13.2 lb)/10 kg (22 lb)
Certifications	FCC class A/CE class A

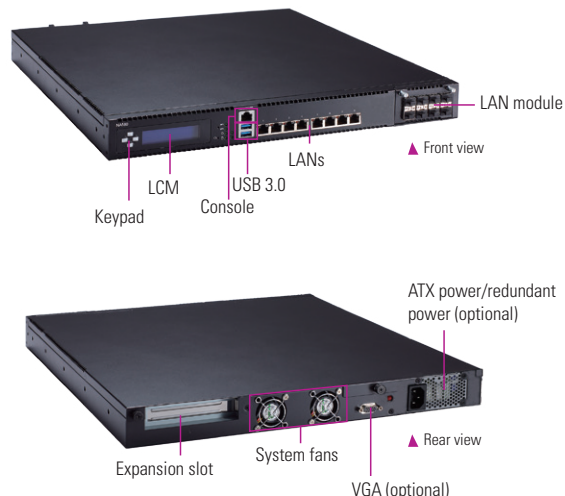

## Ordering Information

Standard	
NA580-R8GI-C236 (P/N: E26E580100)	1U rackmount appliance with LGA1151 socket Intel® Xeon® E3/Core™ processor, 8 GbE LANs, 2-pair LAN bypass and 1 expandable LAN module (optional)
NA580-R6GI-H110 (P/N: E26E580101)	1U rackmount appliance with LGA1151 socket Intel® Core™ processor, 6 GbE LANs, 2-pair LAN bypass and 1 expandable LAN module (optional)
NA580-R8GI-C236-US with IPMI (P/N: E26E580114)	1U rackmount appliance with LGA1151 socket Intel® Xeon® E3/Core™ processor, 8 GbE LANs, 1 IPMI port, 2-pair LAN bypass and 1 expandable LAN module (optional)

## Optional

5916E552000E	DB9F-RJ-45 1.8M console cable for Cisco
--------------	---

\* Specifications and certifications may vary based on different requirements.

## Packing List

1 x SATA cable
1 x Power cord

## Dimensions

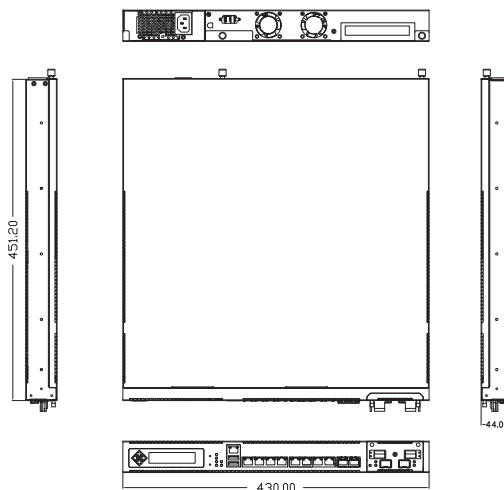

# NA362R

1U Rackmount Network Appliance Platform with Intel® Atom® Processor C3558/ C3758 and up to 10 LANs

## Features

- Intel® Atom® processor C3558/C3758 (Denverton)
- Four DDR4 R-DIMM/U-DIMM for up to 128GB of memory
- Six 10/100/1000 Mbps Ethernet ports and four 10GbE SFP+ ports
- Supports Intel® QuickAssist Technology
- Supports Intel® Data Plane Development Kit (Intel® DPDK)
- Suitable for VPN, network bandwidth controller, firewall and UTM applications

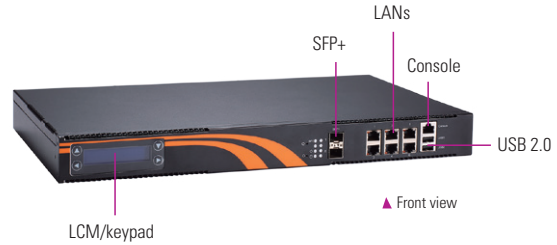

## Specifications

System	
CPU	Intel® Atom® processor C3558/C3758 (Denverton)
Chipset	SoC integrated
Memory	4 x DDR4 R-DIMM/U-DIMM, not allowed mixing, up to 128GB non-buffer non-ECC/ECC memory
BIOS	AMI SPI Flash BIOS
Storage	2 x 2.5" SATA3 HDD 1 x mSATA
Network Interface	6 x 10/100/1000 Mbps Ethernet (Intel® i210) 2 x 10GbE SFP+ (C3558)/4 x 10GbE SFP+ (C3758)
I/O	1 x RS-232 (RJ-type) 2 x USB 2.0 6 x RJ-45 + 2 x SFP+ (C3558); 4 x SFP+ (C3758)
Other Features	LAN Bypass function through latch relay (one pair)
Expansion Interface	N/A
Watchdog Timer	255 stepping for system reset 8 stepping for LAN Bypass
Power Supply	120W open frame
OS Compatibility	Yocto, Linux

## Mechanical/ Environmental

Form Factor	1U rackmount
LED	Power, HDD, GPIO programmable, LAN Bypass, Link/Act with transfer rate
Operating Temperature	0°C to +45°C (+32°F to +113°F)
Humidity	10% to 95% RH, non-condensing
Chassis Material	Steel
Dimensions	44 mm (1.73") (H) x 430 mm (16.93") (W) x 251 mm (9.88") (D)
Weight (net/gross)	3.5 kg (7 lb)/4.5 kg (9 lb)
Certifications	FCC class A/CE class A

## Ordering Information

Standard	
NA362R-R8MI-C3558-US (P/N:E26E362103)	1U rackmount network appliance with Intel® Atom® processor C3558, 6 GbE LANs and 2 SFP+ ports
NA362R-RAMI-C3758-US (P/N:E26E362104)	1U rackmount network appliance with Intel® Atom® processor C3758, 6 GbE LANs and 4 SFP+ ports

## Optional

5916E552000E	DB9F-RJ-45 1.8M console cable for Cisco
--------------	---

\* Specifications and certifications may vary based on different requirements.

## Packing List

- 1 x SATA cable
- 1 x Power cord

## Dimensions

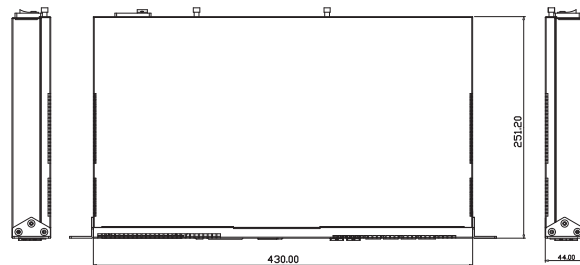



SOHO Network Appliances

SMB Network Appliances

Edge Server Platforms



# Network Appliances



# 3

## Edge Server Platforms

In IoT environment, more and more data was generated in local and need a powerful system to provide not only high performance computing but also hardware acceleration to handle specific application with low latency, for example, AI inference or network security. Axiomtek's Edge Server is a hybrid server platform. It includes CPU, GPU and Switch features in one system and provides the flexible hardware resource to virtual functions. General x86 server grade CPU provides high performance computing power for most of application and it can also equip GPU card to accelerate AI inference and switch to accelerate packet processing. The embedded IPMI provides out-of-band management function make it easy to be managed even when main system is down. In the conclusion, Axiomtek's Edge Server is preferred platform designed for the risen application demanding in the IoT world.

Selection Guide		367
 iSvr560	2U Compact Edge Server Platform with Intel® Xeon® Processor and 24-port GbE Managed Switch	368
 iSvr660	2U Slim Edge Server Platform with Intel® Dual Purley Scalable Processor and 24-port GbE Managed Switch	369

# Edge Server Platforms

## Selection Guide

NEW

Coming soon

NEW

Coming soon

Features \ Models	iSvr560	iSvr660	
<b>Form Factor</b>	2U Compact	2U Slim	
<b>Processor</b>	LGA1151 Intel® Coffee Lake Xeon® processor	LGA3647 Intel® Purely scalable dual processor	
<b>Chipset</b>	Intel® C246	Intel® C621	
<b>BIOS</b>	AMI SPI Flash BIOS	AMI SPI Flash BIOS	
<b>Memory</b>	<b>Technology</b>	DDR4-2400	DDR4-2400
	<b>Max Capacity</b>	Up to 64GB non-ECC/ECC	Up to 384GB non-ECC/ECC
	<b>Socket</b>	4 x 288-pin RDIMM	12 x 288-pin RDIMM
<b>Network Interface</b>	<b>Switch</b>	24 port managed switch	24 port managed switch
	<b>Ethernet</b>	N/A	2 x RJ-45
<b>Storage</b>	<b>HDD</b>	2 x 2.5" SSD	2 x 2.5" SSD
	<b>SATA</b>	1 x SATA DOM	1 x SATA DOM
	<b>USB</b>	2 x USB 3.0	2 x USB 3.0
<b>I/O</b>	<b>Console</b>	1 x RJ-45	1 x RJ-45
	<b>Management</b>	1 x RJ-45 management port	1 x RJ-45 management port
	<b>VGA</b>	1 x VGA	1 x VGA
<b>GPU card interface</b>	MXM (PCIe x8) slot	2 x PCIe x16 slot	
<b>IPMI</b>	IPMI 2.0	IPMI 2.0	
<b>TPM</b>	TPM 2.0	TPM 2.0	
<b>Fanless</b>	Smart fan	Smart fan	
<b>Power Supply</b>	9 to 36 DC	Single/redundant AC	
<b>Operating Temperature</b>	0°C to +40°C (+32°F to +104°F)	0°C to +40°C (+32°F to +104°F)	
<b>OS Support</b>	Linux/Windows	Linux/Windows	
<b>Dimensions (H x W x D)</b>	88 x 240 x 240 mm (3.46" x 9.44" x 9.44")	88 x 350 x 600 mm (3.46" x 13.78" x 23.62")	
<b>Certifications</b>	CE/FCC	CE/FCC	

# iSvr560 NEW

2U Compact Edge Server Platform with Intel® Xeon® Processor and 24-port GbE Managed Switch

## Features

- Intel® Xeon® processor (codename: Coffee Lake)
- Four 288-pin DDR4 R-DIMM for up to 64GB of memory
- 24-port GbE managed switch
- Supports L3 switch function
- Supports GPU card
- Supports IPMI 2.0 remote management

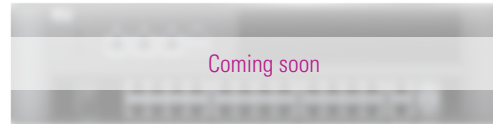

## Specifications

System	
CPU	LGA1151 Intel® Xeon® processor (Coffee Lake)
Chipset	C246
Memory	4 x 288-pin DDR4 2400 R-DIMM, up to 64GB non ECC/ECC memory
BIOS	AMI SPI Flash BIOS
Storage	2 x 2.5" SATA3 SSD 1 x SATA DOM
Network Interface	24-port GbE L3 managed switch
I/O	2 x USB 3.0 1 x RJ-45 console 1 x RJ-45 management port 1 x VGA
GPU Interface	MXM (PCIe x8) slot
IPMI	1 x IPMI 2.0
Watchdog Timer	255 stepping for system reset
Power Supply	9 to 36 VDC
OS Compatibility	Linux/Windows

## Mechanical/ Environmental

Form Factor	2U compact
LED	Power, HDD, GPIO programmable, Link/Act with transfer rate
Operating Temperature	0°C to +40°C (+32°F to +104°F)
Humidity	10% to 95% RH, non-condensing
Chassis Material	Steel
Dimensions	88 mm (3.46") (H) x 240 mm (9.44") (W) x 240 mm (9.44") (D)
Weight (net/gross)	TBD
Certifications	CE/FCC class A

## Ordering Information

Standard	
iSvr560	2U compact edge server platform with Intel® Xeon® processor and 24-port GbE managed switch

Optional	
M3N1030-JN	NVIDIA® Pascal™ MXM3.1 Type A GeForce® GT1030 Module
M3N1050-LN	NVIDIA® Pascal™ MXM3.1 Type A GeForce® GTX1050 Module
M3N1050TI-LN	NVIDIA® Pascal™ MXM3.1 Type A GeForce® GTX1050 Ti Module

\* Specifications and certifications may vary based on different requirements.



# iSvr660 NEW

2U Slim Edge Server Platform with Intel® Dual Purley Scalable Processor and 24-port GbE Managed Switch

## Features

- Intel® Purley scalable dual processor
- Twelve 288-pin DDR4 R-DIMM for up to 384GB of memory
- 24-port GbE managed switch
- Supports L3 switch function
- Supports two GPU cards
- Supports IPMI 2.0 remote management

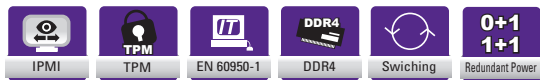
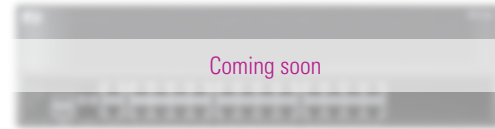

## Specifications

System	
CPU	LGA3647 Intel® Purely scalable dual processor
Chipset	C621
Memory	12 x 288-pin DDR4 2400 R-DIMM, up to 384GB non ECC/ECC memory
BIOS	AMI SPI Flash BIOS
Storage	2 x 2.5" SATA SSD SATA DOM
Network Interface	24-port GbE L3 managed switch 2 x GbE LAN
I/O	2 x USB 3.0 1 x RJ-45 console 1 x RJ-45 management port 1 x VGA
GPU Interface	2 x PCIe x16 slot
IPMI	IPMI 2.0
Watchdog Timer	255 stepping for system reset
Power Supply	Single/redundant AC
OS Compatibility	Linux/Windows

## Mechanical/ Environmental

Form Factor	2U slim
LED	Power, HDD, GPIO programmable, Link/Act with transfer rate
Operating Temperature	0°C to +40°C (+32°F to +104°F)
Humidity	10% to 95% RH, non-condensing
Chassis Material	Steel
Dimensions	88 mm (3.46") (H) x 350 mm (13.78") (W) x 600 mm (23.62") (D)
Weight (net/gross)	TBD
Certifications	CE/FCC class A

## Ordering Information

Standard	
iSvr660	2U slim edge server platform with Intel® Dual Purley Scalable Processor and 24-port GbE managed switch
Optional	
N1030-J6FL	NVIDIA® Pascal™ PCI Express x16 GeForce® GT1030 Industrial Graphic Card
N1050-J9FX	NVIDIA® Pascal™ PCI Express x16 GeForce® GTX1050 Industrial Graphic Card
N1050TI-L9FX	NVIDIA® Pascal™ PCI Express x16 GeForce® GTX1050 Ti Industrial Graphic Card

\* Specifications and certifications may vary based on different requirements.



**Axiomtek** maintains a global network of international subsidiaries and distributors representing the Axiomtek brand in more than 60 countries.

### **Prompt Worldwide Service**

To maximize service efficiency, Axiomtek employs an international service network, providing worldwide technical support and sales service among the 13 offices located in Taiwan, America, Europe, Thailand, Malaysia, Japan and China ensure prompt service to customers.

Axiomtek has successfully assisted several prestigious business with their customized project execution. Flexibility is a feature of Axiomtek's design-in services, capable of providing customers with any needed customized service.



## ASIA

### Axiomtek Co., Ltd (HQ)

8F., No.55, Nanxing Road, Xizhi District,  
New Taipei City 221, Taiwan

**T/** +886-2-8646-2111

**F/** +886-2-8646-2555

**E/** info@axiomtek.com.tw

### Axiomtek Technology Co., Ltd

10F, Block B, Build 6 (Baohui Building),  
Baoneng Science & Technology Park,  
No.1, Qingxiang Road, Longhua New  
District, Shenzhen 518109, P.R. China

**T/** +86-755-66865899

**F/** +86-755-66863068

**E/** axcn@axiomtek.com.cn

### Axiomtek Japan Co., Ltd.

14F, 1-2-1 Kinshi, Sumida-ku,  
Tokyo, 130-0013, Japan

**T/** +81-3-6853-6675

**F/** +81-3-6853-6601

**E/** info@axiomtek.co.jp

### Axiomtek (Malaysia) Sdn. Bhd.

No 16, Jalan Tandang 51/205A,  
Seksyen 51, 46050 Petaling Jaya, Selangor,  
Malaysia

**T/** +603-77733908

**F/** +603-77733873

**E/** info@axiomtek.com.my

### Axiomtek (Thailand) Co., Ltd.

7/17 Moo 6, Tumbol Banmai,  
Amphur Pakkret, Nonthaburi,  
Thailand 11120

**T/** +662-573-4725

**F/** +662-573-4726

**E/** sales@axiomtek.co.th

## USA

### Axiomtek

18138 Rowland Street, City of Industry,  
CA 91748, USA

**T/** +1-626-581-3232

**F/** +1-626-581-3552

**E/** info@axiomtek.com  
sales@axiomtek.com

### Regional Sales Office

**T/** +1-626-581-3232

Western Region ext. 116

Northeast/Southeast Region ext. 123

North Central Region ext. 189

### Axiomtek Systems

300 Griffin Brook Drive, Methuen,  
MA 01844, USA

**T/** +1-978-258-0108

**E/** sales@axiomteksystems.com

## EU

### Axiomtek Deutschland GmbH

Hans-Böckler-Str. 10,  
40764 Langenfeld, Germany

**T/** +49-2173-399360

**F/** +49-2173-3993636

**E/** sales@axiomtek.eu

### Axiomtek UK Limited

920 Peter House, Oxford Street,  
Manchester M1 5AN, UK

**T/** +44(0)1612093680

**E/** wen@axiomtek.com.tw

### Axiomtek ITALIA S.r.l.

Via Pavia, 21, 20835 Muggiò (MB),  
Italy

**T/** +39-02-664299.1 r.a.

**F/** +39-02-66400279

**E/** info@axiomtek.it



IoT Solutions  
Alliance

