

Profile

- Compact design
- Universally applicable thanks to standardized interfaces
- Easy mounting
- Measurement lengths up to max. 2000 mm
- Potentiometer, voltage, power output or incremental encoder
- Housing made of reinforced plastic

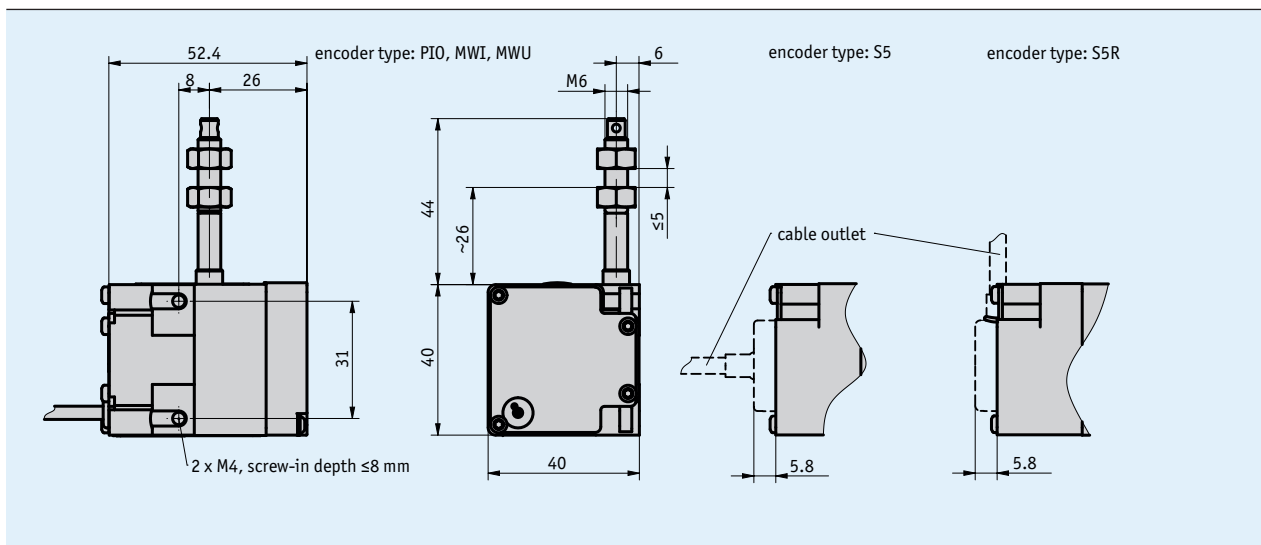

Mechanical data

Feature	Technical data	Additional information
Housing	reinforced plastic	
Wire design	∅0.45 mm	steel wire (stainless), plastic coated
Extension force	≥2 N	
Measured distance/ rope drum revolution	100 mm	
Cable length	≤30 m	P10 + MWI encoder type
	≤20 m	MWU encoder type
Weight	~0.2 kg	

Electrical data

■ Encoder potentiometer

Feature	Technical data	Additional information
Power rating	1.5 W at 70 °C	
Resistance	10 kΩ	
Resistance tolerance	±5 %	
Linearity tolerance	±0.25 %	
	±0.1 %	encoder type MWI/0,1

■ Transducer, power output

Feature	Technical data	Additional information
Operating voltage	24 V DC $\pm 20\%$	at $\leq 500\ \Omega$ load
Output current	4 ... 20 mA	

■ Transducer, voltage output

Feature	Technical data	Additional information
Operating voltage	15 ... 28 V DC	at 3 mA, no load
Output voltage	0 ... 10 V DC	
Load	≤ 15 mA	

* Measurement transducers permit optimum adjustment of the output current and output voltage to the measuring range. The measurement transducer is pre-set at the works so that an output signal of 4 ... 20 mA (MWI) or 0 ... 10 V DC (MWU) is available.

System data

Feature	Technical data	Additional information
Repeat accuracy	± 0.15 mm	
Travel speed	≤ 800 mm/s	

Ambient conditions

Feature	Technical data	Additional information
Ambient temperature	-10 ... 80 °C	without transducer
	0 ... 50 °C	with transducer
Protection category	IP50 (encoder part potentiometer)	EN 600529
	IP54 (incremental)	EN 600529

Pin assignment

■ Potentiometric outputs P10

Signal	E1 (terminal)
Po	brown
Pe	white
S	green

■ MWI transducer

Signal	Cable color
I+	brown
I-	white

■ MWU transducer

Signal	Cable color
+24 V DC	brown
GND	white
U _{out}	green

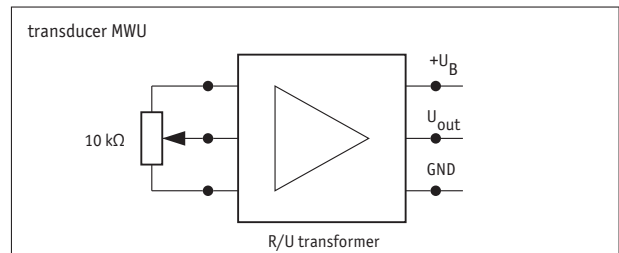
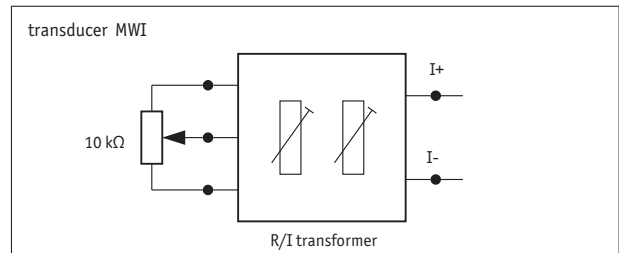
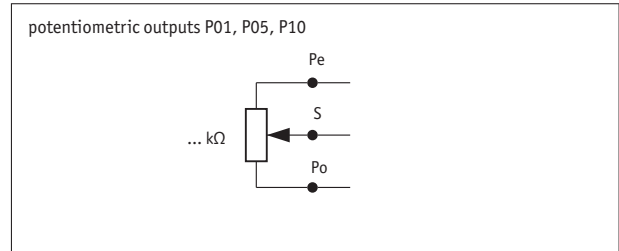

Hint for mounting

When securing the wire it must be ensured that the wire is straight and vertical in relation to the wire outlet.
 Recommendation: Only select the starting position after an unwound length of approx. 5 mm. This prevents the wire hitting the end stop when it is rewound.

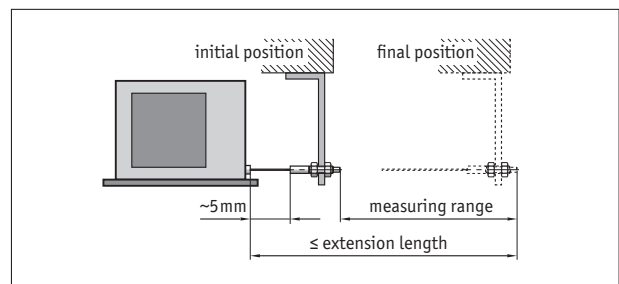

symbolic depiction

Order

Ordering information

For measuring range 2000 I, the rotary encoder IV2800 mounted directly from the factory must be ordered separately.

Ordering table

Feature	Ordering data	Specification	Additional information
Measuring range	...	300, 500, 1000 in mm	encoder types Ω, I, U (potentiometer and transducer) only with encoder type S5, S5R
	2000I		
Encoder type	P10	potentiometer with 10kΩ transducer 4 ... 20 mA	
	MWI		
	MWU	transducer 0 ... 10 V	
	S5	rotary encoder IV2800, axial cable outlet	
	S5R	rotary encoder IV2800, radial cable outlet others on request	
Cable length	0.5	0.5 m	with encoder type P10 or MWI/MWU
	...		1 ... 20 m, in steps of 1 m
	IG	specified via mounted encoder	at measuring range 2000 I

Order key

SG10 - - -
A B C

Scope of delivery: SG10

Accessories:
 Electronic display MA50
 Guide roller UR

www.siko-global.com
www.siko-global.com